

Lb79 _ Accessori_Complementi / Accessoires_Compléments / Accessoires_Ergänzungen



samo
lineabeta



Gentile Cliente,

Il nuovo catalogo Lineabeta Lb79 rappresenta un ulteriore e decisivo passo verso la fusione dell'anima di questo marchio con la casa madre SAMO SpA, icona di eccellenza in Italia ed Europa nel settore delle pareti doccia. Lineabeta un marchio vivace, dinamico, di qualità, rinomato per accessori e complementi d'arredo bagno dal design accattivante rappresenta il completamento ideale delle docce marchiate SAMO, al fine di permettere una proposizione di bagno completa, fresca e giovane.

Il mio augurio è quello che tu possa sfruttare al massimo l'energia sprigionata da questi due marchi, sempre più uniti, infondendo al tuo bagno lo stile e il design ricercato che desideravi.

Il presidente
Denis Venturato

A handwritten signature in black ink, which appears to read 'Denis Venturato'. The signature is fluid and stylized, with a long horizontal stroke extending to the right.

lineabeta

Lb79

NEW

ACCESSORI _ Accessories _ Accessoires _ Accessoires

GRELA pag. 44-45-47-49, Nuovi modelli _ New models _ Nouveaux modèles _ Neue Modelle
GRELA pag. 44-45-46-47-48-49, Nuove finiture _ New finishes _ Nouvelles finitions _ Neuheit Ausführung
DADO pag. 52-53-54-55-56-57, Nuove finiture _ New finishes _ Nouvelles finitions _ Neuheit Ausführung
SAETA pag. 66-69-70, Nuovi modelli _ New models _ Nouveaux modèles _ Neue Modelle
SAETA pag. 66-67-68-69-70, Nuove finiture _ New finishes _ Nouvelles finitions _ Neuheit Ausführung
BAKETO pag. 84-89, Nuovi modelli _ New models _ Nouveaux modèles _ Neue Modelle

PORTASCOPINI _ Toilet brush holder _ Porte-balai _ Wc-Bürstengarnitur

SKOATI pag. 158-159, Nuove finiture _ New finishes _ Nouvelles finitions _ Neuheit Ausführung

PIANTANE _ towel stands _ Ensembles d'accessoires sur pied _ Handtuchständer

POSÀ pag. 171, Nuove finiture _ New finishes _ Nouvelles finitions _ Neuheit Ausführung
GRELA pag. 174, Nuovi modelli _ New models _ Nouveaux modèles _ Neue Modelle
GRELA pag. 174, Nuove finiture _ New finishes _ Nouvelles finitions _ Neuheit Ausführung
BAKETO pag. 176, Nuovi modelli _ New models _ Nouveaux modèles _ Neue Modelle

GETTACARTA - Paper baskets _ Corbeilles à papier _ Papierkorb

BANDONI pag. 188, Nuovi modelli _ New models _ Nouveaux modèles _ Neue Modelle
SESTEI pag. 191, Nuove finiture _ New finishes _ Nouvelles finitions _ Neuheit Ausführung

GRIGLIE DOCCIA _ Shower baskets _ Paniers de douche _ Duschkörbe

FILÒ pag. 230, Nuovi modelli _ New models _ Nouveaux modèles _ Neue Modelle
FILÒ pag. 234, Nuove finiture _ New finishes _ Nouvelles finitions _ Neuheit Ausführung
FILÒ pag. 235, Nuovi modelli _ New models _ Nouveaux modèles _ Neue Modelle
FILÒ pag. 236, Nuovi modelli _ New models _ Nouveaux modèles _ Neue Modelle
RENTÒ pag. 238, Nuovi modelli _ New models _ Nouveaux modèles _ Neue Modelle

CONTRACT _ Contract _ Hôtellerie _ Hotel

OTHELLO pag. 253, Nuovi modelli _ New models _ Nouveaux modèles _ Neue Modelle
OTHELLO pag. 255, Nuovi modelli _ New models _ Nouveaux modèles _ Neue Modelle

SPECCHI INGRANDITORI _ Magnifying mirrors _ Miroirs grossissants _ Wand-Vergrößerungsspiegel

MEVEDO pag. 262, Nuovi modelli _ New models _ Nouveaux modèles _ Neue Modelle

SPECCHI ILLUMINATI Mirrors with light _ Miroirs avec lumière _ Spiegel mit licht

PYXIS pag. 272-273, Nuovi modelli _ New models _ Nouveaux modèles _ Neue Modelle
ZENITH pag. 274, Nuovi modelli _ New models _ Nouveaux modèles _ Neue Modelle
OPEN pag. 286, Nuovi modelli _ New models _ Nouveaux modèles _ Neue Modelle

COLONNE _ Columns _ Colonne _ Hochschränken

CIACOLE pag. 330-331-332-338, Nuove finiture _ New finishes _ Nouvelles finitions _ Neuheit Ausführung

LAVABI FREESTANDING _ Freestanding washbasins _ Lavabos colonne _ Freistehende waschbecken

FÒRA pag. 366-367, Nuovi modelli _ New models _ Nouveaux modèles _ Neue Modelle

40_ACCESSORI _ Accessories _ Accessoires _ Accessoires



| | |
|----------|------|
| Grela | _42 |
| Dado | _50 |
| Roersa | _58 |
| Saeta | _64 |
| Skuara | _72 |
| Baketo | _82 |
| Napie | _92 |
| Duemila | _102 |
| Sbecà | _112 |
| Piccola | _118 |
| Venessia | _126 |

142_ACCESSORI APPOGGIO _ Tabletop accessories _ Accessoires à poser _ Accessoires zum Stand



| | |
|------|------|
| Saon | _142 |
|------|------|

156_SCOPINI _ Toilet brush holders _ Porte-balais _ Wc Bürste



| | |
|----------|------|
| Skoati | _158 |
| Baston | _160 |
| Balenghi | _162 |

168_PIANTANE _ Accessory and towel stands _ Ensembles d'accessoires sur pied ou muraux _ Ständer

Piantane a parete _ Wall ladders _ Porte-serviettes muraux _ Ständer am Wand



| | |
|-------|------|
| Grela | _170 |
| Posà | _171 |

Piantane a pavimento _ Floor accessory and towel stands _ Ensembles d'accessoires sur pied _ Ständer am Boden

| | |
|--------|------|
| Stela | _172 |
| Grela | _174 |
| Ranpin | _175 |

186_COMPLEMENTI _ Complements _ Compléments _ Ergänzungen

Cestini _ Paper baskets _ Corbeilles à papier _ Papierkorb

| | |
|---------|------|
| Bandoni | _188 |
|---------|------|



Portabiancheria _ Laundry baskets _ Paniers à linge _ Wäschekorb

| | |
|--------|------|
| Sestei | _190 |
| Grela | _192 |
| Scagni | _193 |

196_DOCCIA _ Shower _ Douche _ Dusche

Doccia da esterni _ Outdoor shower _ Douche pour usage externe _ Aussendusche beweglich

| | |
|------|------|
| Istà | _198 |
|------|------|

Doccia componibile _ Shower clousure componible _ Paroi de douche modulaires _ Duschkabine komponierbar

| | |
|------|------|
| Toki | _202 |
|------|------|

Soffioni e bracci doccia _ Shower heads and shower-arms _ Pommes de douche et bras de douche _ Kopfbrause und Brausearm

| | |
|---------|------|
| Supioni | _204 |
|---------|------|

Colonne doccia e doccette _ Shower columns and hand shower _ Colonnes de douche et douchettes _ Duschsäulen und Handbrause

| | |
|--------|------|
| Doccia | _208 |
|--------|------|

Pedane _ Shower mats _ Caillebotis _ Duschfußbrette

| | |
|-----------|------|
| Atlantica | _225 |
|-----------|------|

Griglie e accessori doccia _ Shower baskets and shower accessories _ Paniers et accessoires de douche _ Duschkörbe und Duschzubehöre

| | |
|------|------|
| Filo | _228 |
|------|------|

242_CONTRACT _ Contract _ Hôtellerie _ Hotel

Maniglione di sicurezza _ Grab security bar _ Barre d'appui _ Sicherheitsgriff

| | |
|---------|------|
| Othello | _242 |
|---------|------|

Asciugacapelli _ Hairdryer / Sèche-cheveux / Haartrockner

| | |
|---------|------|
| Othello | _248 |
|---------|------|



258_SPECCHI E LAMPADE _ Mirrors and lamps _ Miroirs et lampes _ Spiegel und Lampen

Specchi ingranditori _ Magnifying mirrors _ Miroirs grossissants _ Wand-Vergrößerungsspiegel

Mevedo _ **260**

Specchi con luce _ Mirrors with lighting _ Miroirs avec lumière _ Spiegel mit Licht

Speci _ **268**

Specchi _ Mirrors _ Miroirs _ Spiegel

Speci _ **286**

Lampade / Lamps / Lampes / Lampen

Ciari _ **292**



302_MOBILI E CONTENITORI _ Cabinets and furniture _ Armoires et meubles _ Schränke

Mobili componibile _ Modular furniture _ Meubles à éléments modulaires _ Modulare Möbel

Grela _ **304**

Piani top per lavabi _ Tops for tabletop washbasins _ Plans pour vasques à poser _ Platte zum Waschbecken

De Sora _ **320**

Canavera _ **322**

Supporti per lavabo _ Wash-table units _ Meubles pour lavabo _ Halter zum Waschtisch

Goto _ **326**

Colonne _ Cabinets _ Colonnes _ Spalten

Ciacole _ **330**

Pikà _ **333**

Grela _ **337**

Basi su ruote _ Drawer units on castors _ Meubles sur roulettes _ Schränke auf Rollen

Runners _ **340**

Careto _ **345**



348_LAVABI _ Washbasins _ Lavabos _ Waschbecken

Lavabi da appoggio _ Countertop washbasins _ Vasques à poser _ Aufsatzbecken

Momon _ **352**

Acquaio _ **353**

Quarelo _ **357**

Lavabi a parete _ Wall washbasins _ Lavabos à accrocher au mur _ Wand Becken

Ciuci _ **361**

Pocia _ **361**

Quarelo _ **362**

Freestanding _ Pedestal washbasins _ Lavabos colonne _ Pedestal Waschbecken

Fòra _ **366**

Momon _ **368**

Cadin _ **369**

Lavabi ad incasso _ Built-in washbasins _ Lavabos encastrés _ Einbauwaschbecken

Acquaio _ **372**



374_TERMOARREDI _ Radiators _ Radiateurs _ Heizkörper

Termoarredi elettrici _ Electric radiators _ Radiateurs électriques _ Heizkörper elektrischer

Caligo _ **378**

Termoarredi ad acqua _ Hydraulic radiators _ Radiateurs hydrauliques _ Heizkörper mit Wasser

Caligo _ **380**



388_SIFONI, PILETTE E RUBINETTERIA

Siphons, water drains, taps and fittings _ Siphons, bondes et robinetterie _ Siphons, Ablaufgarnituren und Armaturen

Sifoni _ Siphons _ Siphons _ Siphons

Busi e Cane _ **390**

Pilette _ Water drains _ Bondes _ Ablaufgarnituren

Busi e Cane _ **392**

Prese acqua _ Water outlet _ Sorties d'eau _ Wandanschlussbogen

Busi e Cane _ **395**

Rubinetteria _ Taps and fittings _ Robinetterie _ Armaturen

Canole _ **397**



404_Indice _ Index _ Indice _ Index

408_Condizioni generali di trasporto e vendita

410_General transport and sale terms

412_Conditions générales de vente et de transport

414_Allgemeine Verkaufs und Geschäftsbedingungen

Finiture _ Finishing _ Finitions _ Ausführung

Metallo _ Metal _ Métal _ Metall



.09 _ Bianco opaco _ Matt white _ Blanc mat _ Matt Weiß



.18 _ .23 _ Nero opaco _ Black matt _ Noir mat _ Matt Schwarz

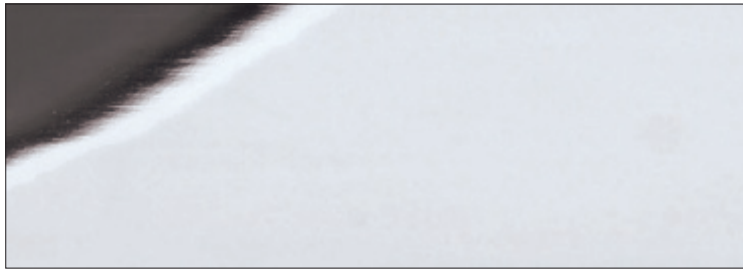

.29 _ Cromo lucido _ Chrome _ Chromét _ Chrom



.30 _ Oro lucido _ Polished gilded _ Doré brillant _ Glänzendes Gold



.32 _ Inox spazzolato _ Brushed stainless _ Inoxydable brossé _ Edelstahl Gebürstet



.34 _ Oro rosato lucido _ Polished gilded pink _ Doré rosé brillant _ Glänzendes Roségold

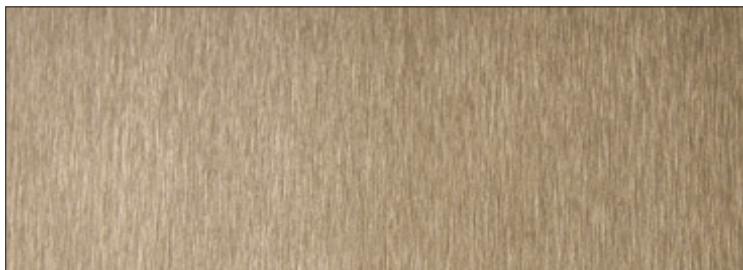

.35 _ Bronzo spazzolato _ Brushed Bronze _ Bronze brossé _ Gebürstet Bronze

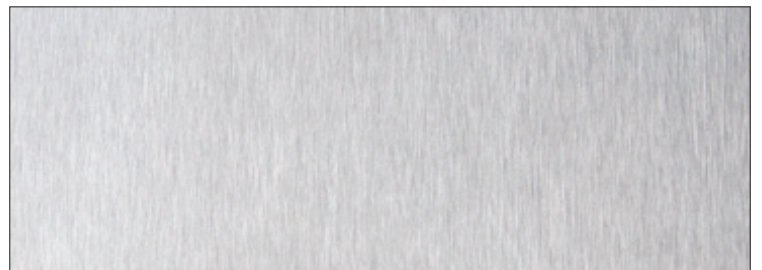

.36 _ Nichel spazzolato _ Brushed Nickel _ Nickel brossé _ Gebürstet Nickel



.37 _ Oro spazzolato _ Brushed gilded _ Doré brossé _ Gebürstet Gold

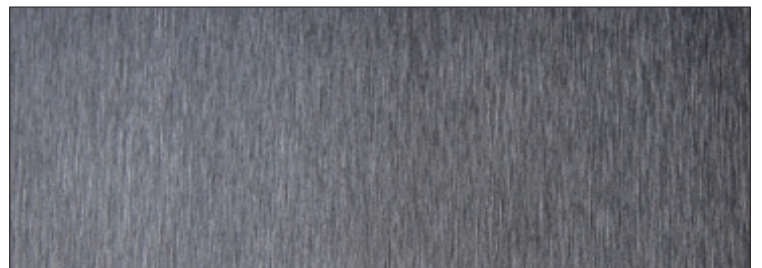

.38 _ Gun Metal spazzolato _ Gun Metal brushed _ Gun Metal brossé _ Gun Metal Gebürstet

Metallo _ Metal _ Métal _ Metall



.55 _ Rosa metalizzato opaco _ Metallic pink matt _ Rose métallisé mat _ Metallic-Rosa matt



.73 _ Sage opaco _ Matt Sage _ Sage mat _ Matt Sage

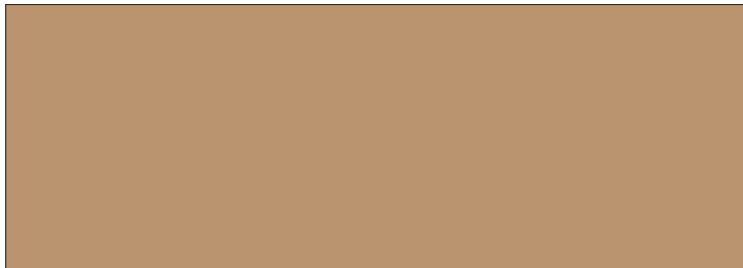

.86 _ Ambra opaco _ Matt Ambra _ Ambra mat _ Matt Ambra

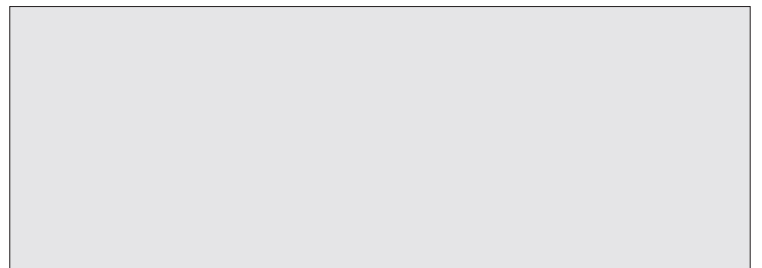

.90 _ Artico opaco _ Matt Artic _ Artic mat _ Matt Artic



.92 _ Sailor Blue opaco _ Matt Sailor Blue _ Sailor Blue mat _ Matt Sailor Blue

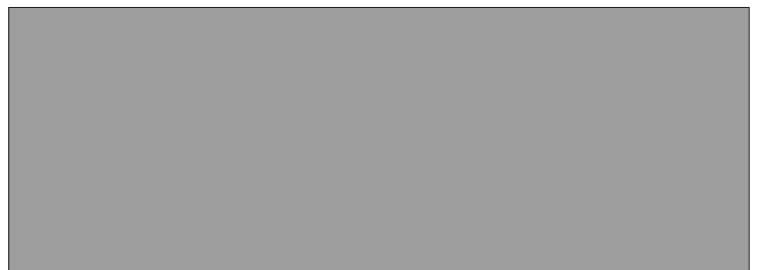

.95 _ Grigio opaco _ Matt grey _ Gris mat _ Matt Grau

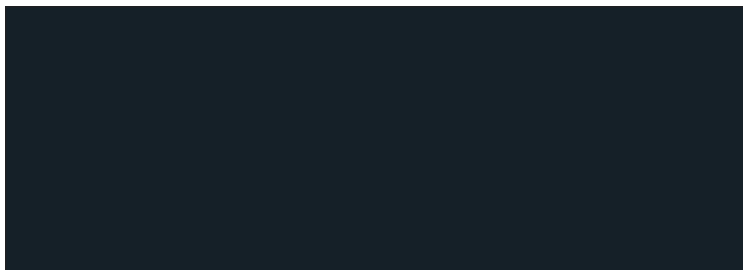

.96 _ Nero opaco _ Matt black _ Noir mat _ Matt Schwarz

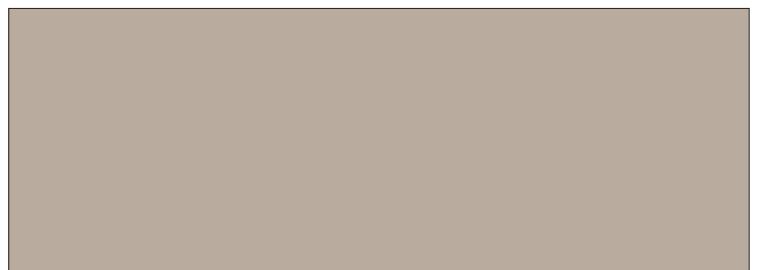

.98 _ Sabbia opaco _ Matt sand _ Sable mat _ Matt Sand



.99 _ Tortora opaco _ Matt Tortora _ Tortora mat / Matt Tortora

Finiture _ Finishing _ Finitions _ Ausführung

Laminato _ Laminated _ Stratifié _ Holzlaminat



.01 _ Olmo bianco _ White elm tree _ Orme blanc _ Weiße Ulme



.02 _ Olmo fumè _ Smoke elm tree _ Orme fumé _ Rauch Ulme

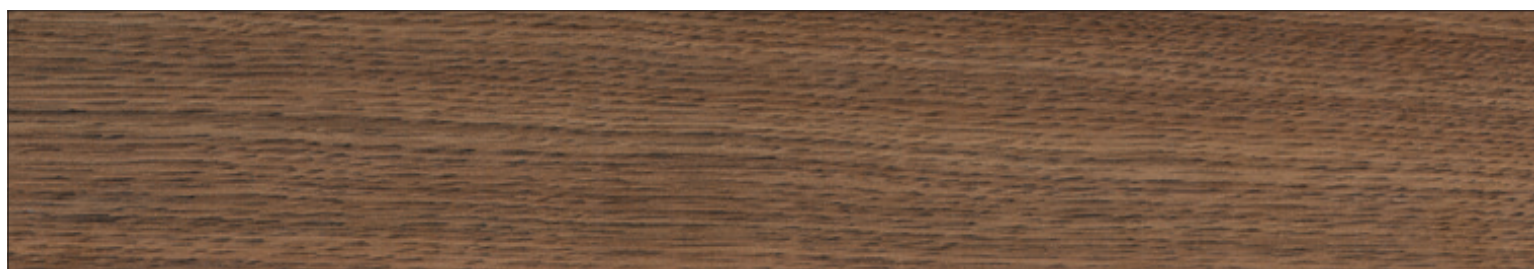

.03 _ Rovere castano _ Brown Oak _ Chêne brun _ Braune Eiche



.05 _ Rovere naturale _ Natural Oak _ Chêne naturel _ Natürliche Eiche

Legno _ Wood _ Bois _ Holz



.03 _ Bambù naturale _ Natural bamboo _ Bambou naturel _ Natürlicher Bambus

Laccato lucido _ Glossy lacquered _ Laqué brillant _ Glänzend Lackiert



.09L _ Bianco _ White _ Blanc _ Weiss



.17L _ Antracite _ Anthracite _ Anthracite _ Anthrazit

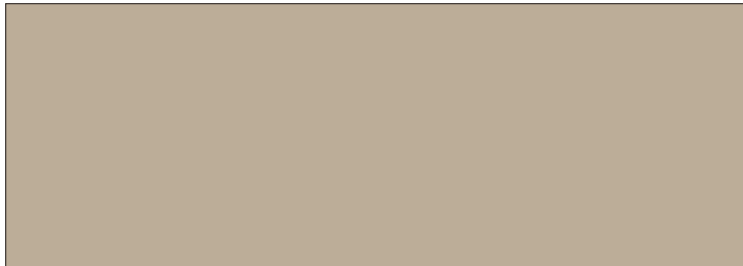

.21L _ Tortora _ Dove grey _ Gris tourterelle _ Taubengrau

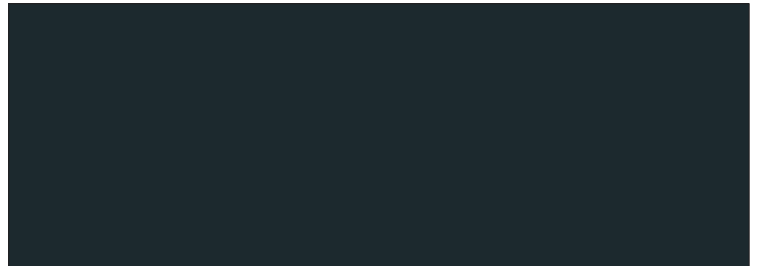

.22L _ Nero _ Black _ Noir _ Schwarz

Laccato opaco / Matt lacquered / Laqué mat / Matt Lackiert

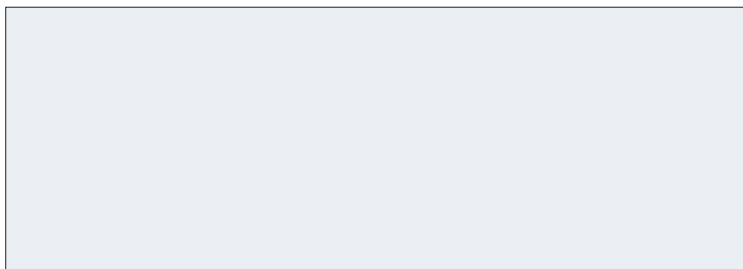

.09 _ Bianco _ White _ Blanc _ Weiss

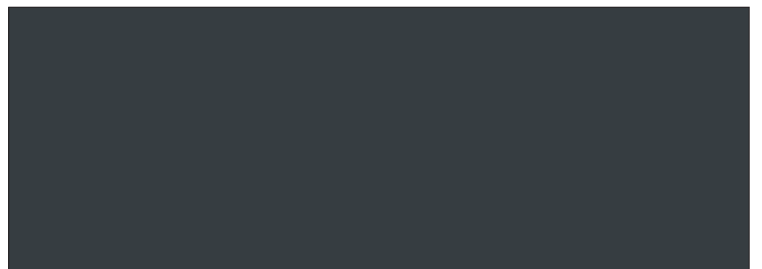

.17 _ Antracite _ Anthracite _ Anthracite _ Anthrazit

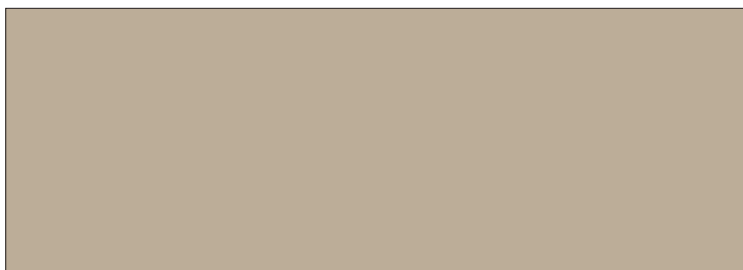

.21 _ Tortora _ Dove grey _ Gris tourterelle _ Taubengrau



.22 _ Nero _ Black / Noir _ Schwarz

Finiture _ Finishing _ Finitions _ Ausführung

Ceramica _ Ceramic _ Céramique _ Keramik



.09 _ Bianca lucida _ Glossy white _ Blanc brillant _ Weiß glänzend



.17 _ Antracite opaca _ Matt anthracite _ Anthracite mat _ Anthrazit matt

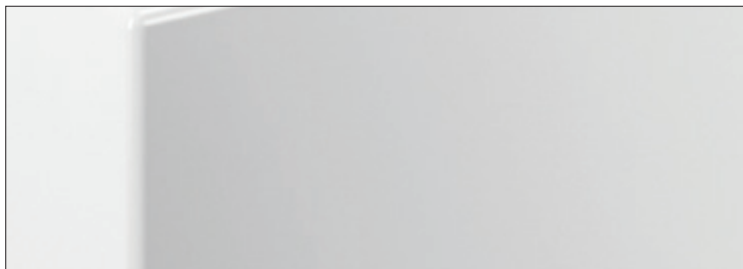

.26 _ Bianca opaca _ Matt white _ Blanc mat _ Weiß matt

Mineralmarmo _ Mineral marble _ Minéral marbre _ Mineralguss

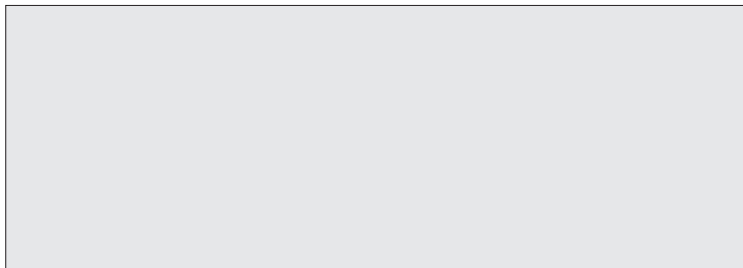

.09 _ Bianco lucido _ Glossy white _ Blanc brillant _ Weiß glänzend

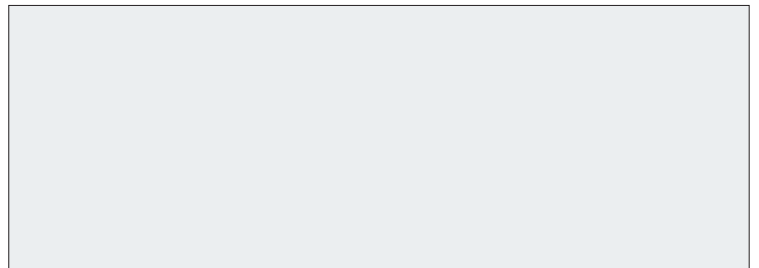

.26 _ Bianco opaco _ Matt white _ Blanc mat _ Weiß matt

Solid Surface _ Solid Surface _ Solid Surface _ Solid Surface

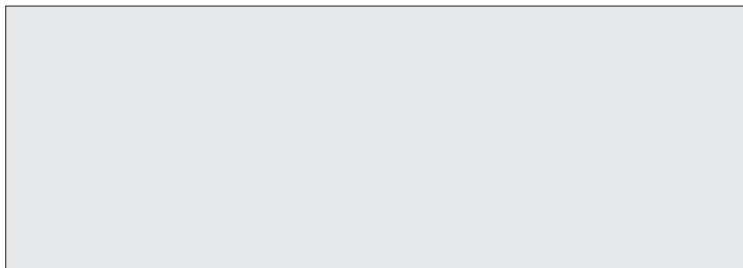

.09 _ Bianco lucido _ Glossy white _ Blanc brillant _ Weiß glänzend

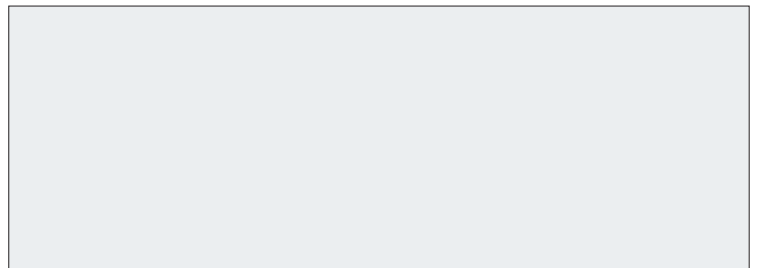

.26 _ Bianco opaco _ Matt white _ Blanc mat _ Weiß matt

Vetro _ Glass _ Verre _ Glas



.80 _ Trasparente _ Transparent _ Transparent _ Klarglas





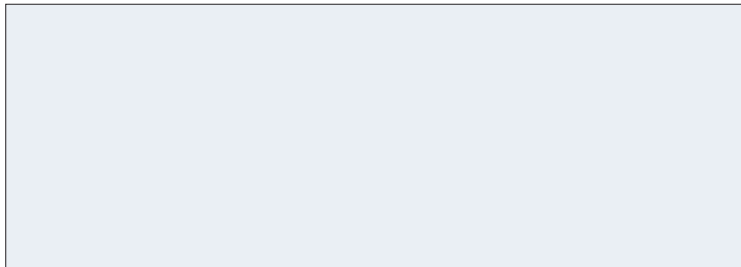



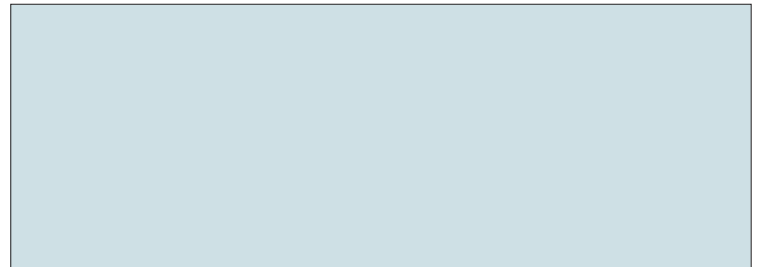



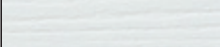









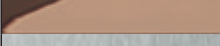
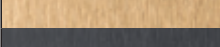
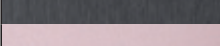

.81 _ Vetro acidato _ Etched glass _ Verre dépoli _ Geätztes Glas

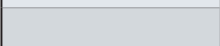
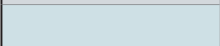
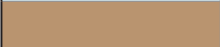
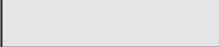

.82 _ Trasparente extrachiaro _ Extraclear transparent _ Transparent extra clair _ Klarglas Extra klar



.84 _ Vetro satinato _ Brushed glass _ Verre satiné _ Glas geätzt

| | | GRELA | DADO | ROERSA | SAETA | SKUARA | BAKETO | NAPIE | DUEMILA | SBECA | PICOLA | VENESSIA | SAON | SKOATI | BASTON | BALENGHI | POSA | STELA | RANPIN | BANDONI | SESTEI | SCAGNI |
|---|-----|-------|------|--------|-------|--------|--------|-------|---------|-------|--------|----------|------|--------|--------|----------|------|-------|--------|---------|--------|--------|
|  | .01 | X | | | | | | | | | | | | | | | | | | | | |
|  | .02 | X | | | | | | | | | | | | | | | | | | | | |
|  | .03 | X | | | | | | | | | | | | | | | | | | | | X |
|  | .05 | X | | | | | | | | | | | | | | | | | | | | |
|  | .08 | | | | | | | | | | | | | | | | | | | | | |
|  | .09 | X | X | | X | | | | | | | | X | X | X | | X | X | | X | | X |
|  | .11 | | | | | | | | | | | | | | X | | | | | | | |
|  | .13 | | | | | | | | | | | | | | X | | | | | | | |
|  | .15 | | | | | | | | | | | | X | | X | | | | | | | |
|  | .16 | | | | | | | | | | | | X | | X | | | | | | | |
|  | .17 | | | | | | | | | | | | X | | X | | | | | | | |
|  | .18 | | | | | | | | | | | | | | X | | | | | | | |
|  | .20 | | | | | | | | | | | | | | | | | | | | | |
|  | .21 | X | | | | | | | | | | | | | | | | | | | | |
|  | .23 | X | X | | X | | X | | | X | | | X | X | | | X | X | | X | X | |
|  | .26 | X | | | | | | | | | | | | | | | | | | | | X |
|  | .29 | X | X | X | | X | X | X | X | X | X | X | X | X | | X | | | X | | X | X |
|  | .30 | | X | | | | | | | | | X | | | | | | | | | | |
|  | .32 | X | | X | | | | X | | | | | | X | | | | | | | X | |
|  | .34 | | X | | | | | | | | | | | | | | | | | | | |
|  | .35 | X | X | | | | | | | | | | | X | | | | | | | | |
|  | .36 | | X | | | | | | | | | | | | | | | | | | | |
|  | .37 | | X | | | | | | | | | | | X | | | | | | | | |
|  | .38 | | X | | | | | | | | | | | X | | | | | | | | |
|  | .55 | X | | | | | | | | | | | | X | | | | | | | | |
|  | .73 | | | | X | | | | | | | | | X | | | X | | | | | |
|  | .76 | | | | | | | | | | | | | | | | | | | | | |
|  | .79 | | | | | | | | | | | | | | | | | | | | | |
|  | .80 | | | | | | | | | | | | | | | | | | | | | |
|  | .81 | | | | | | X | X | X | X | X | | X | | | | | | | | | |
|  | .83 | | | | | | | | | | | | | | | | | | | | | |
|  | .86 | | | | X | | | | | | | | | X | | | X | | | | | |
|  | .90 | | | | X | | | | | | | | | X | | | | | | | | |
|  | .91 | | | | | | | | | | | | | | | | | | | | | |
|  | .92 | | | | X | | | | | | | | | X | | | | | | | | |
|  | .95 | | | | X | | | | | | | | | X | | | | | | | | |
|  | .96 | | | | | | | | | | | | | | | | | | | | | |
|  | .98 | | | | X | | | | | | | | | X | | | | | | | | |
|  | .99 | | | | X | | | | | | | | | X | | | | | | | | |

| | ISTÀ | TOKI | SUPIONI | DOCIA | ATLANTICA | FILO | OTHELLO | MEVEDO | SPECI | CIARI | DE SORA | CANAVERA | GOTO | CIACOLE | PIKA | RUNNER | CARETO | MOMON | ACOUAIO | OUARELO | FORA | CADIN | CALIGO | BUSI & CANE | CANOLE | |
|-----|------|------|---------|-------|-----------|------|---------|--------|-------|-------|---------|----------|------|---------|------|--------|--------|-------|---------|---------|------|-------|--------|-------------|--------|--|
| .01 | | | | | | | | | | | X | | | | X | | | | | | | | | | | |
| .02 | | | | | | | | | | | X | | | | X | | | | | | | | | | | |
| .03 | | | | | | | | | | | X | X | | | X | | | | X | | | | | | | |
| .05 | | | | | | | | | | | X | | | | X | | | | | | | | | | | |
| .08 | | | | | X | | | | | | | | | | | | | | | | | | | | | |
| .09 | X | | X | X | | X | X | X | X | X | X | | | X | X | X | X | | X | X | | | X | X | | |
| .11 | | | | | | | | | | | | | | X | | | | | | | | | | | | |
| .13 | | | | | | | | | | | | | | | | | | | | | | | | | | |
| .15 | | | | | | | | | | | | | | X | | | | | | | | | | | | |
| .16 | | | | | | | | | | | | | | | | | | | | | | | | | | |
| .17 | | | | X | | | | | | | X | | | X | X | | | | X | X | | | X | X | | |
| .18 | | | | | | | | | | | | | | | | | | | | | | | | | | |
| .20 | X | | | | | | | | | | | | | | | | | | | | | | | | | |
| .21 | | | | | | | | | | | X | | | X | X | | | | | X | | | | | | |
| .23 | | | X | X | | X | X | X | X | X | X | | | X | X | X | X | | | | | X | X | X | | |
| .26 | | | | | | | | | | | | | | | | X | | X | X | X | | X | | X | | |
| .29 | | | X | X | | X | X | X | X | X | | | X | | | X | | | X | X | | X | X | X | X | |
| .30 | | | | | | | | | | | | | | | | | | | | | | | | | | |
| .32 | | | | X | | X | X | | X | X | | | | | | | | | X | | | | X | | X | |
| .34 | | | | | | | | | | | | | | | | | | | | | | | | | | |
| .35 | | | | | | | | | X | | | | | | | | | | | | | | | | | |
| .36 | | | | | | | | | | | | | | | | | | | | | | | | | | |
| .37 | | | | | | | | | | | | | | | | | | | | | | | | | | |
| .38 | | | | | | | | | | | | | | | | | | | | | | | | | | |
| .55 | | | | | | | | | X | | | | | | | | | | | | | | | | | |
| .73 | | | | | | X | | | X | | | | | X | | | | | | | | | | | | |
| .76 | | | | | | | | | | | | | | | | | | | | | | X | | | | |
| .79 | | | | | | | | | | | | | | | X | | | | | | | | | | | |
| .80 | | X | | | | | | | | | | | | | | | | | | | | | | | | |
| .81 | | | | | | | | | | | | | | | | | | | | | | | | | | |
| .83 | | | | | | | | | | | | | | | | | | | | | | | | | | |
| .86 | | | | | | X | | | X | | | | | X | | | | | | | | | | | | |
| .90 | | | | | | X | | | | | | | | | | | | | | | | | | | | |
| .91 | | | | | | | | | | | | | | | | | | | | | | | | | | |
| .92 | | | | | | X | | | | | | | | | | | | | | | | | | | | |
| .95 | | | | | | X | | | | | | | | | | | | | | | | X | | | | |
| .96 | | X | | | | | | | | | | | | | | | | | | | | | | | | |
| .98 | | | | | | X | | | | | | | | | | | | | | | | | | | | |
| .99 | | | | | | X | | | | | | | | | | | | | | | | X | | | | |

Come comporre il codice

Comment composer le code _ How to create a code _ Bestellschlüssel

Descrizione

Description
Description
Beschreibung

Finiture

Finishing
Finitions
Ausführung

Coppia appendini

2 Hooks / Jeu de 2 patères / Paar Hacken



Immagine prodotto

Product image
Image du produit
Produktbild

| | | | |
|--------------|---|---|--|
| | Metallo cromo Chromed metal Métal chromé Chrom Metall | Metallo satinato Satined metal Métal satiné Vereist Metall | Metallo nero opaco Matt black metal Métal noir mat Schwarz Matt Metall |
| 61207 | .29 | .36 | .23 |
| € | 50,00 | 70,00 | 57,00 |
| | Oro rosato lucido Polished gilded pink Doré rosé brillant Glänzendes Roségold | Metallo oro Gold colored metal Métal couleur or Gold Metall | Metallo bronzo Bronze metal Métal couleur bronze Bronze Metall |
| 61207 | .34 | .30 | .35 |
| € | 74,00 | 72,00 | 74,00 |

61207 .34

Oro rosato lucido

Polished gilded pink
Doré rosé brillant
Glänzendes Roségold

Articolo / Article / Article / Artikel

61207 = DADO, coppia appendini

DADO, 2 Hooks
DADO, Jeu de 2 patères
DADO, Paar Hacken

Tempi di spedizione

Delivery Ex Works _ Délais _ Verfügbarkeit ab Werk

Disegno tecnico

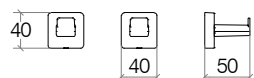

Technical drawing
Dessin technique
Technische Zeichnung



Metallo cromo
Chromed metal
Métal chromé
Chrom Metall

Metallo satinato
Satinated metal
Métal satiné
Vereist Metall

Metallo nero opaco
Matt black metal
Métal noir mat
Schwarz Matt Metall

| | | | |
|--------------|--|---|---|
| 61207 |  .29 |  .36 |  .23 |
| € | 50,00 | 70,00 | 57,00 |

Tempi di spedizione

Delivery Ex Works
Délais
Verfügbarkeit ab Werk

A = 1 settimana

1 week
1 semaine
1 Woche

C = 3-4 settimane

3-4 weeks
3-4 semaines
3-4 Wochen

HOME | contract | outdoor



| HOME |

Pensiamo al bagno come l'ambiente che più di tutti avvalorata e qualifica una casa. Un luogo intimo, privato e prezioso: il vero spazio dedicato al sé.

Realizziamo soluzioni di design capaci di influenzare gli stili di vita delle persone grazie a prodotti nati dalla creatività italiana.

EN_For us, the bathroom is the room that represents and qualifies a home more than any other. It is an intimate, private and precious room: a really personal place.

We develop design solutions capable of influencing people's lifestyles thanks to products originating from Italian creativity.

FR_Nous pensons la salle de bains comme la pièce qui, comme aucune autre, valorise et caractérise une maison. Un lieu intime, personnel et précieux : le véritable espace dédié à soi.

Nous créons des solutions de design capables d'influencer les styles de vie de chacun grâce à des produits issus de la créativité italienne.

DE_Wir sehen das Bad als Ambiente, das mehr als alle anderen ein Haus ausmacht und ihm Wert verleiht. Ein intimer, ein privater, ein kostbarer Ort: der eigentliche Raum, den man sich selbst widmet.

Wir realisieren Designlösungen, die es vermögen, den Lebensstil der Menschen mit Produkten zu beeinflussen, die der italienischen Kreativität entspringen.





home | **CONTRACT** | outdoor



| CONTRACT |

Pubblico e privato, per noi di Lineabeta sono la stessa cosa: il bagno deve essere pratico, funzionale e accessibile da chiunque in qualunque momento. Deve rispondere alle esigenze di tutti, offrendo sempre altissimi standard di igiene, qualità e sicurezza.

EN _ For us at Lineabeta, the public sector is no different from the private one: the bathroom must be practical, functional, and accessible to anyone at any time. It must meet everyone's needs, always offering the highest standards of hygiene, quality and safety.

FR _ Public ou privé, pour nous Lineabeta, c'est pareil : la salle de bains doit être pratique, fonctionnelle et accessible à tous et à tout moment. Elle doit répondre aux attentes de chacun, garantissant toujours les plus élevés standards d'hygiène, de qualité et de sécurité.

DE _ Öffentlich und privat - für uns von Lineabeta dasselbe: das Bad muss praktisch, funktionell und jederzeit für jeden zugänglich sein. Es muss den Bedürfnissen aller entsprechen und bei Hygiene, Qualität und Sicherheit stets höchste Standards bieten.





home | contract | **OUTDOOR**



| OUTDOOR |

L'arredamento outdoor ricrea lo stesso comfort dell'interno nel proprio spazio verde.

L'Istà è la doccia che provvede alla frescura tanto cercata nelle afose giornate estive, per poi essere riposta durante l'inverno.

EN Outdoor furniture dedicated to our green spaces recreates the same comfort that can be found indoors. Istà is the shower that provides the much sought-after coolness in the sultry summer days, which can be stored away during the winter.

FR Le mobilier outdoor a vocation de recréer à l'extérieur le même confort qu'à l'intérieur. Istà est la douche qui apporte la fraîcheur tant recherchée les jours d'été les plus chauds, pour être ensuite rangée pendant l'hiver.

DE Die Einrichtung im Außenbereich schafft im eigenen grünen Eckchen denselben Komfort, wie im Innenbereich. Istà ist die Dusche, die für jene kühle Frische sorgt, die man sich an schwülen Sommertagen so herbeisehnt. Für den Winter wird sie dann hereingeholt.





CONTEMPORARY MOOD

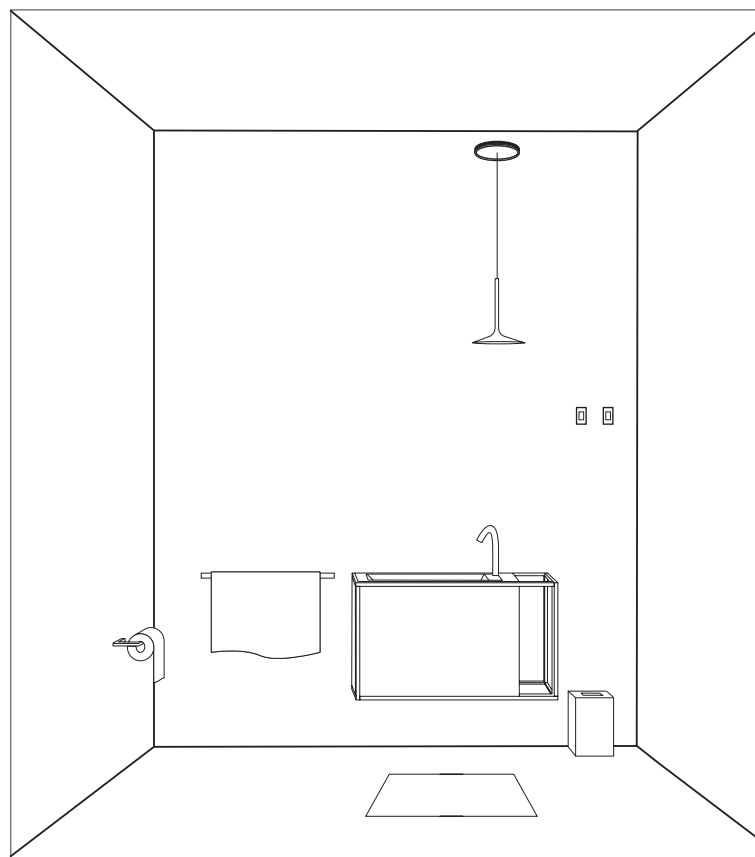

Specchio _ Mirrors _ Miroirs _ Spiegel

SPECI

Accessorio _ Accessories _ Accessoires _ Zubehör

SKUARA

Lavabo _ Washbasins _ Lavabos _ Waschbecken

GRELA

Mobile _ Furniture _ Meubles _ Möbel

GRELA

Lampade _ Lamps _ Lampes _ Lampen

CIARI

Complementi _ Complements _ Compléments _ Ergänzungen

SESTEI



CIARI_Cod.5730.09 - p.295



SPECI_EUROPA_Cod.58100-135 - p.278-9



SKUARA_Cod.52853.29 - p.074



SKUARA_Cod.52813-14-15-16.29 - p.075



GRELA_Cod.8260.03-8621.09-53572.26 - p.314-5



BANDONI_Cod.53442.09 - p.188



CONTEMPORARY MOOD

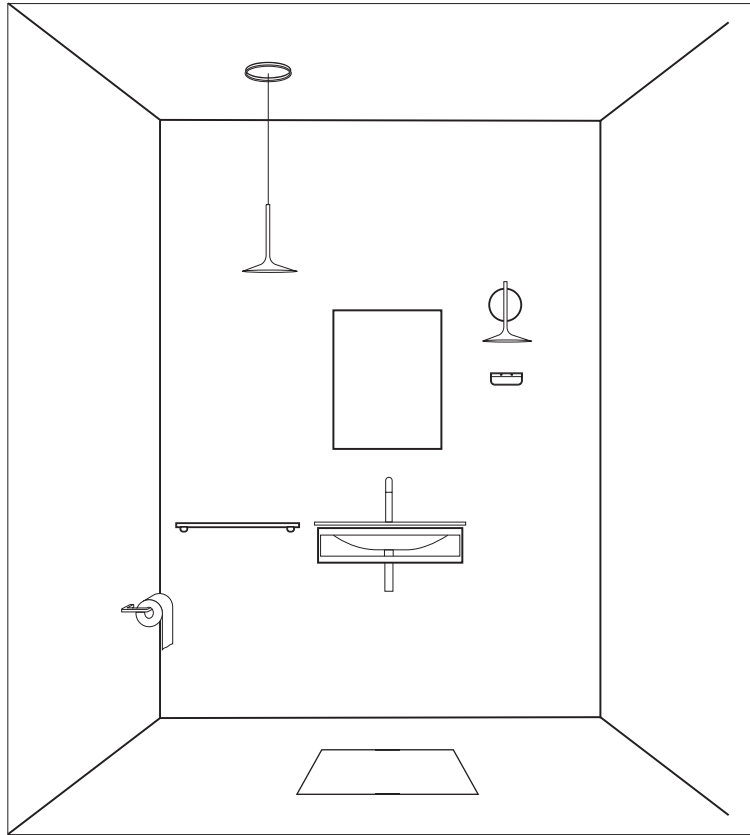

Specchio _ Mirrors _ Mirrors _ Spiegel

SPECI

Accessorio _ Accessories _ Accessoires v Accessoires

SAETA

Lavabo _ Washbasins _ Lavabos _ Waschbecken

POCIA

Colonna _ Column _ Colonne _ Hochschränken

PIKÀ

Lampade _ Lamps _ Lampes _ Lampen

CIARI



CIARI_Cod.5730.09 - p.295



SPECI_Cod.56303-307 - p.288



CIARI_Cod.5729.09 - p.294



SAETA_Cod. 51813.09 - p.066



PIKÀ_Cod.51506.29 - p.335



POCIA_Cod.665801.29 - p.361



SAETA_Cod. 51811.09 - p.066



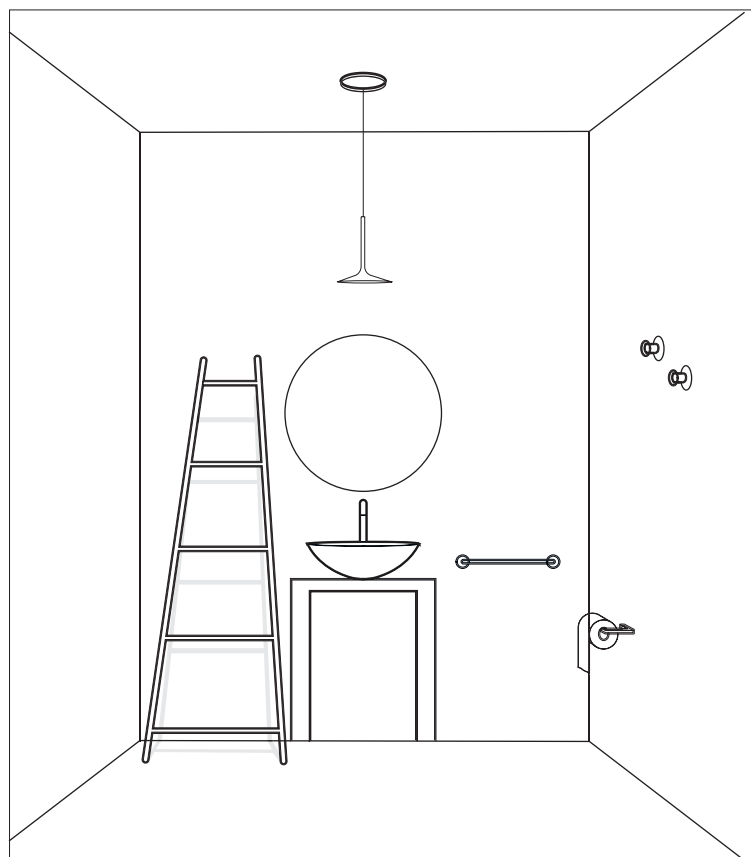

Specchio _ Mirrors _ Miroirs _ Spiegel

SPECI

Accessorio _ Accessories _ Accessoires _ Accessoires

DUEMILA

Lavabo _ Washbasins _ Lavabos _ Waschbecken

ACQUAIO

Mobile _ Furniture _ Meubles _ Möbel

CANAVERA

Piantana _ Towel stands _ Ensembles d'accessoires sur pied ou muraux _ Ständer

POSÀ

Lampade _ Lamps _ Lampes _ Lampen

CIARI

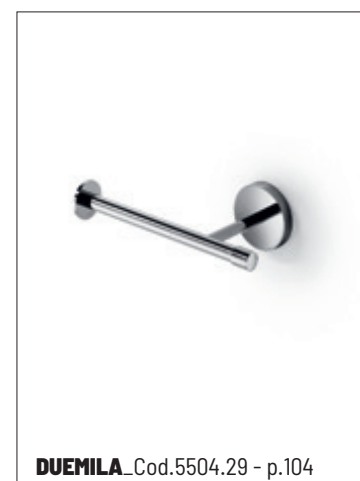
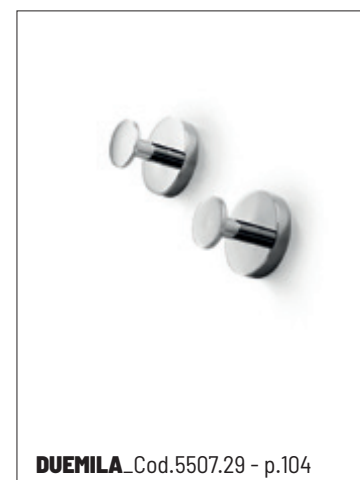
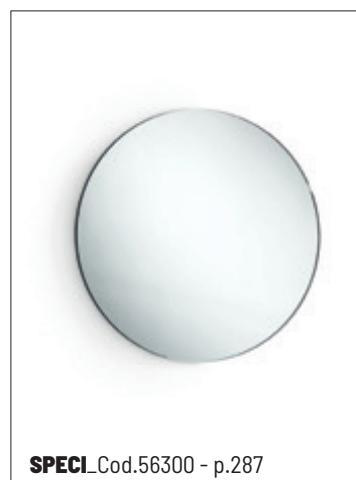



ESSENTIAL MOOD

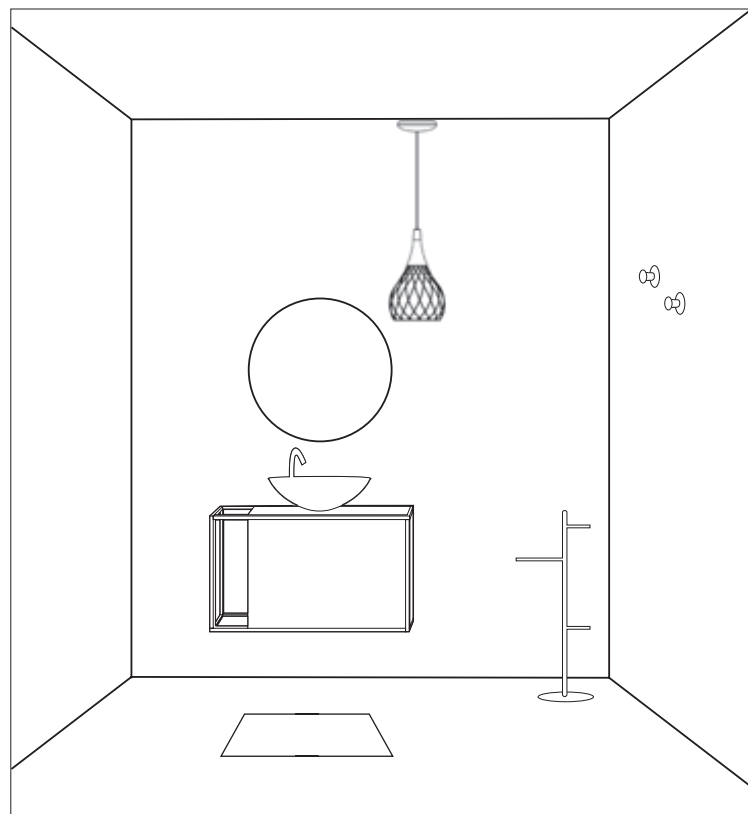

Specchio _ Mirrors _ Miroirs _ Spiegel

SPECI

Accessorio _ Accessories _ Accessoires _ Zubehöre

NAPIE

Lavabo _ Washbasins _ Lavabos _ Waschbecken

ACQUAIO

Mobile _ Furniture _ Meubles _ Möbel

GRELA

Piantana _ Towel stands _ Ensembles d'accessoires sur pied _ Ständer

RANPIN

Lampade _ Lamps _ Lampes _ Lampen

CIARI



CIARI_Cod.5731.18 - p.295



SPECI_Cod.5671 - p.284



NAPIE_Cod.53136.29 - p.095



RANPIN_Cod.5120.29 - p.178



GRELA_Cod.8262.22-8261.29
8620.22 - p.314-5



ACQUAIO_536981.09 - p.356



MUST HAVE MOOD

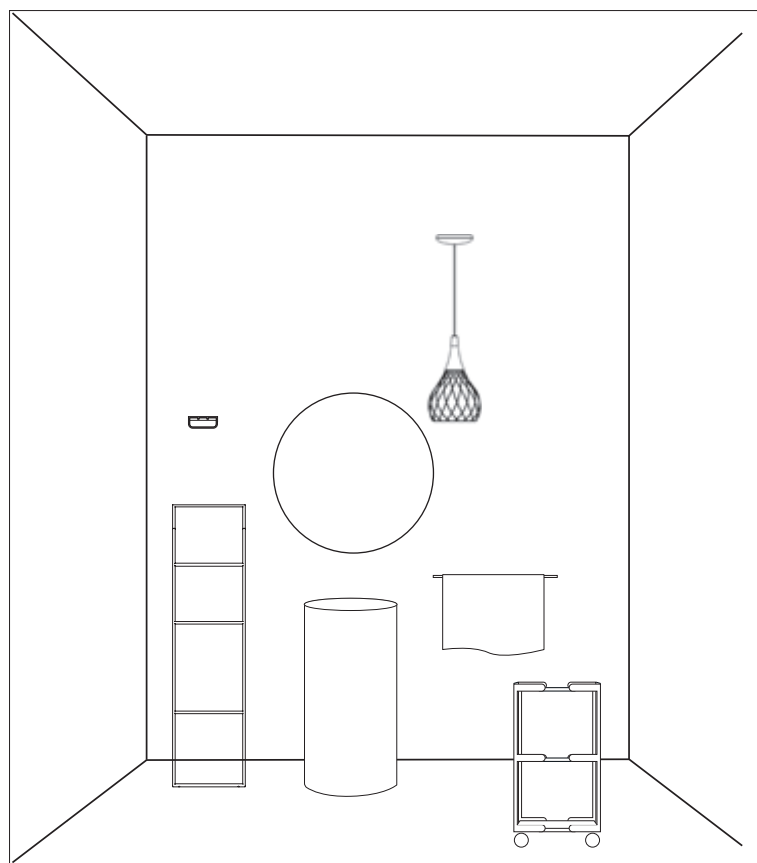

Specchio _ Mirrors _ Miroirs _ Spiegel

SPECI

Accessorio _ Accessories _ Accessoires _ Zubehör

ROERSA

Lavabo _ Washbasins _ Lavabos _ Waschbecken

MOMON

Mobile _ Furniture _ Meubles _ Möbel

CARETO

Piantana _ Towel stands _ Ensembles d'accessoires sur pied ou muraux _ Ständer

GRELA

Lampade _ Lamps _ Lampes _ Lampen

CIARI

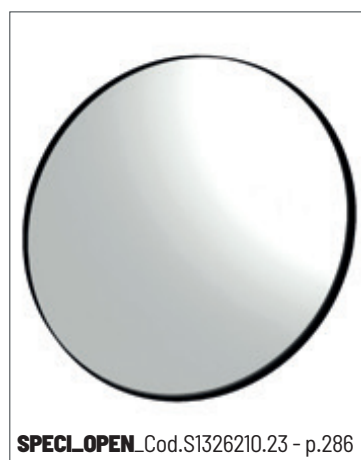



Oltre 40 anni di design italiano

40 years of Italian design _ 40 ans de design italien _ 40 Jahre italienisches Design

Lineabeta è il marchio del lusso accessibile, bello e dinamico nel mondo del bagno.

Lineabeta interpreta il quotidiano di chi desidera progettare e arredare il bagno con un tocco di freschezza, funzionalità, semplicità, ironia.

Sogniamo per tutti un bagno confortevole, allestito con prodotti funzionali all'uso, facili da tenere puliti, destinati a durare nel tempo e dall'estetica sempre contemporanea, accessibili ai più.

La forte identità dei nostri prodotti è legata ai nomi scelti per le nostre collezioni.

Nomi mai scelti a caso, coerenti con la forma o la funzione cui devono assolvere, strettamente legati al territorio perché espressi nella nostra lingua, il Veneto.

Rendiamo disponibili i nostri prodotti tramite canali di vendita preferenziali quali boutique specializzate nell'arredo bagno, i punti vendita dell'idrotermosanitario, il retail mobili e il contract.

EN / Lineabeta is the accessible, beautiful and dynamic luxury brand for bathrooms.

Lineabeta exemplifies the daily life of those who want to design and furnish the bathroom with a fresh, functional, simple and ironic touch.

Our dream is to give everybody a comfortable bathroom, equipped with functional items, which is easy to keep clean and designed to last over time, characterized by a contemporary aesthetics and accessible to most people.

As the "everyday design" tag line explains, we aim to obtain an environment that can be used every day simply and effortlessly.

The strong identity of our products is linked to the names chosen for our collections.

The names were not chosen at random as they are consistent with the form they have or the function they must perform, and are closely connected to the territory because they are expressed in our language, the Venetian dialect.

We sell our products through preferential sales channels such as boutiques specializing in bathroom furnishings, points of sale in the plumbing and heating sector, as well as in the furniture retail and contract sectors.

FR / Lineabeta est la marque du Luxe accessible, esthétique et dynamique dans le monde de la salle de bains.

Lineabeta interprète la vie quotidienne de ceux qui souhaitent concevoir et équiper leur salle de bains d'une touche de fraîcheur, de fonctionnalité, de simplicité, d'esprit.

Nous rêvons tous d'une salle de bains confortable, équipée de produits fonctionnels, faciles à entretenir, destinés à durer dans le temps, et à l'esthétique toujours plus contemporaine, accessible à tous.

Comme le dit notre slogan "everyday design", nous aspirons à un environnement pour vivre au quotidien de manière simple et spontanée.

La forte identité de nos produits est liée aux noms choisis pour nos collections.

Des noms jamais choisis au hasard, cohérents avec la forme ou la fonction qu'ils doivent assumer, et étroitement liés au territoire car ils sont déclinés dans notre langue, le vénitien.

Nos produits sont disponibles au travers de canaux de vente préférentiels tels que boutiques spécialisées dans l'aménagement de salle de bains, points de vente dédiés au sanitaire, magasins de meubles et le contract.

DE / Lineabeta ist der

Markenname für erschwinglichen, schönen und dynamischen Luxus im Bad.

Lineabeta interpretiert den Alltag dessen, der das Bad mit der gewissen Frische, Funktionalität, Einfachheit und Ironie planen und einrichten möchte.

Wir erträumen uns für alle ein komfortables Bad, ausgestattet mit bedienungs- und reinigungsfreundlichen Produkten, die für eine lange Lebensdauer ausgelegt sind, eine Optik besitzen, die stets zeitgemäß ist und die für die meisten von uns erschwinglich sind.

Wie der Slogan "everyday design" erahnen lässt, erstreben wir ein Ambiente, das täglich einfach und spontan erlebt werden kann.

Die starke Persönlichkeit unserer Produkte ist mit den Namen verbunden, die wir für unsere Kollektionen gewählt haben.

Namen, die niemals Zufall sind, Namen, die die Form oder die zu erfüllende Aufgabe beinhalten und eng mit der hiesigen Gegend verbunden sind, weil sie in unserer Sprache ausgedrückt werden, dem Veneto-Dialekt.

Wir bieten unsere Produkte über Vorzugskanäle an, etwa über auf Badeinrichtungen spezialisierte Boutiquen, über Verkaufsstellen für Heizungs- und Sanitäreinrichtungen, über den Möbeleinzelhandel und über Anbieter ganzheitlicher Ausstattungskonzepte.

Mission

Offriamo a molti l'opportunità di vivere un prodotto nato da persone che lavorano con creatività pensando alle esigenze di tutti.

We offer the opportunity to experience a product designed by people who put their creativity at the service of everybody's needs.

Nous offrons l'opportunité à beaucoup de découvrir un produit pensé par des personnes qui travaillent avec créativité en prenant en compte des exigences de tous.

Wir bieten Vielen die Möglichkeit, ein Produkt zu erleben, das von Personen stammt, die kreativ arbeiten und dabei die Bedürfnisse aller im Auge behalten.

I nostri valori

our values _ nos valeurs _ unsere werte

Passione

passion _ passion _ Leidenschaft

Coraggio

courage _ courage _ Mut

Collaborazione

teamworking _ collaboration _ Zusammenarbeit

Rispetto

respect _ respect _ Respekt

Integrità

integrity _ intégrité _ Integrität

Green Vision _ Green Vision _ Green Vision _ Green Vision

Lineabeta utilizza al 100% energia da fonti rinnovabili

Le Garanzie d'Origine GO sono dei certificati internazionali che vengono riconosciuti a quegli impianti di produzione di energia elettrica che rispettano determinate caratteristiche di sostenibilità ambientale. Nati nel 2009, ad oggi sono lo strumento principale per garantire la tracciabilità dell'energia prodotta e sostengono la promozione e lo sviluppo di un mercato su base volontaria dell'energia pulita prodotta da fonti rinnovabili.

L'obiettivo della certificazione GO è quello di garantire al cliente che una quantità di energia pari a quella da lui consumata sia stata prodotta da impianti alimentati da una fonte rinnovabile ben definita in un determinato periodo di tempo. Mediante l'utilizzo di certificati GO, l'acquirente finanzia l'energia pulita testimoniando il proprio impegno a favore dell'ambiente.

Lineabeta e il mondo GREEN

Un impegno costante nel tempo.

Dopo questo primo exploit nel mondo green, l'impegno di Lineabeta si è indirizzato verso il consumo di energia - per la propria attività produttiva - derivata al 100% da fonti rinnovabili.

A questo impegno fa eco la certificazione CO2 della produzione, e la compensazione dell'impatto nell'ambiente di diossido di carbonio di tutte le attività di marketing del marchio Lineabeta, attraverso l'acquisto di Carbon Credits.

L'impegno a favore dell'ambiente è un cammino che Lineabeta desidera percorrere da protagonista, con la consapevolezza che non ci si può mai sentire "abbastanza" soddisfatti dei propri passi e dei propri comportamenti, a favore di un'economia realmente sostenibile dal nostro amato pianeta.



Lineabeta uses 100% energy from renewable sources

The GO - Guarantees of Origin - are recognized international certificates for electricity production factories that respect certain environmental sustainability characteristics. Established

in 2009, they are today the main tool ensuring the traceability of the energy produced and supporting the promotion and development of the market for clean energy produced from renewable resources.

The aim of GO certification is to ensure the customer that an amount of energy equal to that which they have consumed has been produced by factories powered by a well-defined renewable source over a given period of time. Through the use of GO certificates, the buyer finances clean energy by demonstrating its commitment to the environment.

Lineabeta and the GREEN world.

A constant commitment over time.

When the commitment to the environment and the eco-sustainability of production activities were making their first stirrings.

This commitment is characterized by the CO2 certification of the production of showers, and the compensation of the carbon dioxide impact on the environment of all the marketing activities of the Lineabeta brand, through the purchase of Carbon Credits.

The commitment to the environment is a path that Lineabeta wishes to take as a protagonist, while being aware that one is never completely satisfied with his own approaches and behavior, in favor of a truly sustainable economy for our beloved planet.

Lineabeta utilise 100% d'énergie issue de ressources renouvelables

Les Garanties d'Origine GO sont des certificats internationaux attribués aux centrales de production d'électricité qui respectent des caractéristiques déterminées en faveur du développement durable. Mises en place en 2009, elles sont aujourd'hui le principal outil pour garantir la traçabilité de l'énergie produite et pour soutenir la promotion et le développement d'un marché sur base volontariste de l'énergie propre provenant de ressources renouvelables. L'objectif de la certification GO est de garantir au client qu'une quantité d'énergie égale à celle qu'il a consommée a été produite par des usines alimentées par une ressource renouvelable bien définie sur une période de temps donnée. Grâce à l'utilisation de certificats GO, l'acheteur finance une énergie propre en affirmant son engagement pour l'environnement.

Lineabeta et le monde GREEN.

Un engagement constant dans le temps.

Dès les balbutiements de l'engagement en faveur de l'environnement et du développement durable dans le cadre des activités de production,

A cet engagement se fait écho la certification CO2 de la production des parois de douches, et la compensation de l'impact en dioxyde de carbone sur l'environnement de toutes les activités marketing de la marque Lineabeta, par l'achat de Crédits-carbone.

L'engagement en faveur de l'environnement est un chemin que Lineabeta souhaite emprunter en tant que protagoniste, tout en ayant conscience que l'on ne peut jamais se sentir suffisamment satisfait de ses propres démarches et de son comportement, en faveur d'une économie véritablement respectueuse de notre planète bien-aimée.

Lineabeta nutzt 100% Energie aus erneuerbaren Quellen

Die Herkunftsnachweise GO sind internationale Bescheinigungen, die jenen stromproduzierenden Anlagen zuerkannt werden, die bei der ökologischen Nachhaltigkeit bestimmten Eigenschaften genügen. 2009 eingeführt, sind sie heute das wichtigste Instrument, um die Rückverfolgbarkeit der gewonnenen Energie zu gewährleisten. Außerdem fördern sie auf freiwilliger Basis die Entwicklung eines Marktes sauberer, aus erneuerbaren Quellen gewonnener Energie.

Die Zertifizierung GO soll dem Kunden garantieren, dass eine Energiemenge, die der von ihm verbrauchten Menge entspricht, in Anlagen gewonnen worden ist, die in einem bestimmten Zeitraum von einer genau definierten erneuerbaren Quelle gespeist worden sind. Durch die Nutzung von GO-Zertifikaten finanziert der Käufer saubere Energie und bezeugt seinen Einsatz für die Umwelt.

Lineabeta e il mondo GREEN

Ein unaufhörlicher Einsatz.

Sichtbares Zeichen für diese Anstrengungen ist die CO2-Zertifizierung der Duschenproduktion und die Kompensation der Auswirkungen, die Marketingaktivitäten der Marke Lineabeta wegen ihres Kohlendioxid-Ausstoßes auf die Umwelt haben, durch den Erwerb von Kohlenstoffgutschriften (Carbon Credits). Der Einsatz für die Umwelt ist ein Weg, den Lineabeta als Hauptakteur begehen will, in dem Bewusstsein, dass man sich nie zufrieden „genug“ über seine Schritte und seine Verhaltensweisen zugunsten einer für unseren geliebten Planeten wirklich nachhaltigen Wirtschaft fühlen kann.



accessori

Accessories _ Accessoires _ Accessoires

GRELA _ 42



DADO _ 50

ROERSA _ 58

SAETA _ 64

SKUARA _ 72

BAKETO _ 82

NAPIE _ 92



DUEMILA _ 102



SBECA _ 112

PICOLA _ 118



VENESSIA _ 126

GRELA
ACCESSORI _ Accessories _ Accessoires _ Accessoires



GRELA: nel nostro dialetto, la graticola: quell'oggetto di ferro sul quale vengono appoggiati i cibi per cuocerli sul fuoco o sulla brace. Una serie di accessori, mobili e complementi dallo stile industrial, adatta ad ambienti moderni e metropolitani.

GRELA è perfettamente abbinabile alla serie **PYXIS** di **SAMO**

EN

GRELA: in our dialect, the grill: that iron object on which food is placed to be cooked on fire or on embers.

A range of accessories and furniture characterized by an industrial style, suitable for modern and metropolitan environments.

GRELA perfectly complements the **PYXIS** series by **SAMO**

FR

GRELA : dans notre dialecte vénitien, la grille : accessoire en fer sur lequel les aliments sont placés pour les cuire au feu ou sur les braises.

Une série d'accessoires au style industriel, adaptée aux environnements modernes et urbains.

GRELA s'harmonise parfaitement avec la série **PYXIS** de **SAMO**

DE

GRELA: in unserem Dialekt bezeichnet das Wort einen Bratrost: den Gegenstand aus Eisen demnach, auf den Speisen gelegt werden, um sie über dem Feuer oder der Glut zu garen.

Eine Serie aus Zubehör, Möbeln und Ergänzungselementen im Industrial-Stil, die sich für ein modernes und weltstädtisches Ambiente eignet.

GRELA passt perfekt zur **PYXIS**-Serie von **SAMO**

FINITURE _ Finishes _ Finitions _ Ausführung:

Verniciato bianco opaco

Painted matt white
Laqué blanc mat
Lackiertem Matt Weiß



.09

Verniciato nero opaco

Painted matt black
Laqué noir mat
Lackiert Matt Schwarz



.23

Acciaio inox lucido

Polished stainless steel
Acier inoxydable brillant
Edelstahl glänzend



.29

Acciaio inox satinato

Satinated stainless steel
Acier inoxydable satiné
Vereist Edelstahl



.32

Metallo bronzo

Bronze metal
Métal bronze
Bronze Metall



.35

Verniciato rosa metallizzato

Painted metallic pink matt
Laqué rose métallisé mat
Lackiertem Metallic-Rosa matt



.55*

*** .55 Finitura su richiesta acquistando almeno 3 pezzi della serie /**

Custom finish when purchasing at least 3 pieces from the series /

Finition personnalisée lors de l'achat d'au moins 3 pièces de la série /

Kundenspezifische Oberfläche bei Kauf von mindestens 3 Stücken aus der Serie



Fissaggio con viti a muro _ Screwed to the wall _ Fixation au mur avec vis _ Wandbefestigung mit Schrauben

GRELA

Portarotolo

Toilet paper holder / Porte-rouleau / Toilettenpapierhalter

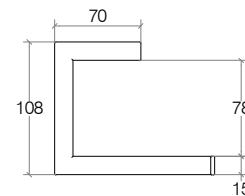
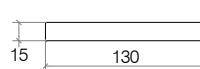

Verniciato bianco
Painted white
laqué blanc
Lackiertem Weiß

Verniciato nero
Painted black
laqué noir
Lackiertem Schwarz

Acciaio inox
Stainless steel
Acier inoxydable
Edelstahl

Acciaio inox satinato
Satinated stainless steel
Acier inoxydable satiné
Vereist Edelstahl

Bronzo spazzolato
Brushed bronze
Bronze brossée
Bronze gebürstet

Rosa metallizzato
Metallic pink matt
Rose métallisé mat
Metallic-Rosa matt



51701

.09

.23

.29

.32

.35

.55

€

80,00

80,00

106,00

111,00

130,00

130,00



Portarotolo con coperchio portacellulare

Toilet paper holder with mobile phone cover / Porte-rouleau avec housse pour téléphone portable / Toilettenpapierhalter mit Mobiltelefonhülle

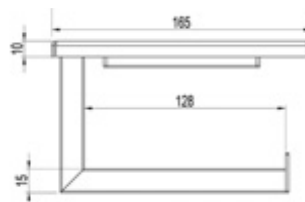
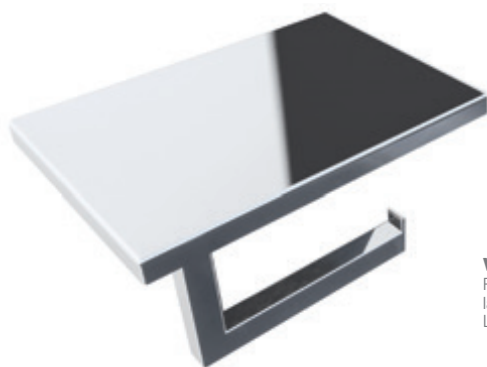

Verniciato bianco
Painted white
laqué blanc
Lackiertem Weiß

Verniciato nero
Painted black
laqué noir
Lackiertem Schwarz

Acciaio inox
Stainless steel
Acier inoxydable
Edelstahl

Acciaio inox satinato
Satinated stainless steel
Acier inoxydable satiné
Vereist Edelstahl

Bronzo spazzolato
Brushed bronze
Bronze brossée
Bronze gebürstet

Rosa metallizzato
Metallic pink matt
Rose métallisé mat
Metallic-Rosa matt



new

51721

.09

.23

.29

.32

.35

.55

€

110,00

110,00

135,00

148,00

175,00

175,00



Appendino a L

L shaped hook / Patère L / Hacken L

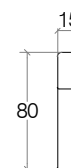

Verniciato bianco
Painted white
laqué blanc
Lackiertem Weiß

Verniciato nero
Painted black
laqué noir
Lackiertem Schwarz

Acciaio inox
Stainless steel
Acier inoxydable
Edelstahl

Acciaio inox satinato
Satinated stainless steel
Acier inoxydable satiné
Vereist Edelstahl

Bronzo spazzolato
Brushed bronze
Bronze brossée
Bronze gebürstet

Rosa metallizzato
Metallic pink matt
Rose métallisé mat
Metallic-Rosa matt



51702

.09

.23

.29

.32

.35

.55

€

55,00

55,00

74,00

78,00

90,00

90,00



GRELA

Appendino a G

G shaped hook / Patère G / Hacken G

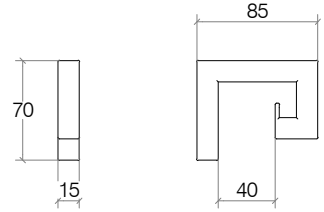

Verniciato bianco
Painted white
laqué blanc
Lackiertem Weiß



Verniciato nero
Painted black
laqué noir
Lackiertem Schwarz



Acciaio inox
Stainless steel
Acier inoxydable
Edelstahl



Acciaio inox satinato
Satinated stainless steel
Acier inoxydable satiné
Vereist Edelstahl



| | | | | |
|--------------|------------|------------|------------|------------|
| 51703 | .09 | .23 | .29 | .32 |
| € | 84,00 | 84,00 | 111,00 | 117,00 |



Appendino doppio

Double hook / Double patère L / Doppelter Hacken

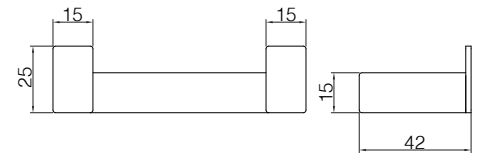

Verniciato bianco
Painted white
laqué blanc
Lackiertem Weiß



Verniciato nero
Painted black
laqué noir
Lackiertem Schwarz



Acciaio inox
Stainless steel
Acier inoxydable
Edelstahl



Acciaio inox satinato
Satinated stainless steel
Acier inoxydable satiné
Vereist Edelstahl



Bronzo spazzolato
Brushed bronze
Bronze brossé
Bronze gebürstet



Rosa metallizzato
Metallic pink matt
Rose métallisé mat
Metallic-Rosa matt



new

| | | | | | | |
|--------------|------------|------------|------------|------------|------------|------------|
| 51723 | .09 | .23 | .29 | .32 | .35 | .55 |
| € | 65,00 | 65,00 | 85,00 | 94,00 | 105,00 | 105,00 |



Portasalviette 400 mm

Towel rail 400 mm / Porte-serviettes 400 mm / Handtuchhalter 400 mm

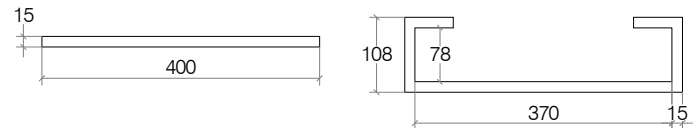

Verniciato bianco
Painted white
laqué blanc
Lackiertem Weiß



Verniciato nero
Painted black
laqué noir
Lackiertem Schwarz



Acciaio inox
Stainless steel
Acier inoxydable
Edelstahl



Acciaio inox satinato
Satinated stainless steel
Acier inoxydable satiné
Vereist Edelstahl



Bronzo spazzolato
Brushed bronze
Bronze brossé
Bronze gebürstet



Rosa metallizzato
Metallic pink matt
Rose métallisé mat
Metallic-Rosa matt



| | | | | | | |
|--------------|------------|------------|------------|------------|------------|------------|
| 51705 | .09 | .23 | .29 | .32 | .35 | .55 |
| € | 134,00 | 134,00 | 179,00 | 189,00 | 220,00 | 220,00 |



GRELA

Portasalviette 600 mm

Towel rail 600 mm / Porte-serviettes 600 mm / Handtuchhalter 600 mm

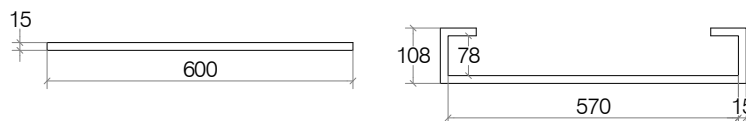

Verniciato bianco
Painted white
laqué blanc
Lackiertem Weiß

Verniciato nero
Painted black
laqué noir
Lackiertem Schwarz

Acciaio inox
Stainless steel
Acier inoxydable
Edelstahl

Acciaio inox satinato
Satinated stainless steel
Acier inoxydable satiné
Vereist Edelstahl

Bronzo spazzolato
Brushed bronze
Bronze brossé
Bronze gebürstet

Rosa metallizzato
Metallic pink matt
Rose métallisé mat
Metallic-Rosa matt



| | | | | | | |
|--------------|------------|------------|------------|------------|------------|------------|
| 51706 | .09 | .23 | .29 | .32 | .35 | .55 |
| € | 151,00 | 151,00 | 204,00 | 215,00 | 245,00 | 245,00 |



Portasalviette - porta accessori 400 mm

Towel rail - accessories bar 400 mm / Porte-serviettes - support pour accessoires 400 mm / Handtuchhalter - Halter für Accessoires 400 mm

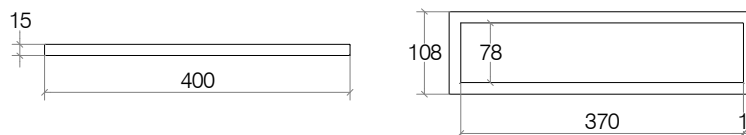

Verniciato bianco
Painted white
laqué blanc
Lackiertem Weiß

Verniciato nero
Painted black
laqué noir
Lackiertem Schwarz

Acciaio inox
Stainless steel
Acier inoxydable
Edelstahl

Acciaio inox satinato
Satinated stainless steel
Acier inoxydable satiné
Vereist Edelstahl

Bronzo spazzolato
Brushed bronze
Bronze brossé
Bronze gebürstet

Rosa metallizzato
Metallic pink matt
Rose métallisé mat
Metallic-Rosa matt



| | | | | | | |
|--------------|------------|------------|------------|------------|------------|------------|
| 51708 | .09 | .23 | .29 | .32 | .35 | .55 |
| € | 169,00 | 169,00 | 218,00 | 229,00 | 275,00 | 275,00 |



Portasalviette - porta accessori 600 mm

Towel rail - accessories bar 600 mm / Porte-serviettes - support pour accessoires 600 mm / Handtuchhalter - Halter für Accessoires 600 mm

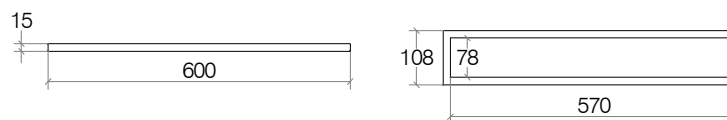

Verniciato bianco
Painted white
laqué blanc
Lackiertem Weiß

Verniciato nero
Painted black
laqué noir
Lackiertem Schwarz

Acciaio inox
Stainless steel
Acier inoxydable
Edelstahl

Acciaio inox satinato
Satinated stainless steel
Acier inoxydable satiné
Vereist Edelstahl

Bronzo spazzolato
Brushed bronze
Bronze brossé
Bronze gebürstet

Rosa metallizzato
Metallic pink matt
Rose métallisé mat
Metallic-Rosa matt



| | | | | | | |
|--------------|------------|------------|------------|------------|------------|------------|
| 51709 | .09 | .23 | .29 | .32 | .35 | .55 |
| € | 175,00 | 175,00 | 229,00 | 241,00 | 290,00 | 290,00 |



Portasalvietta da bidet

Bidet towel holder / Porte-serviette pour bidet / Bidet-Handtuchhalter

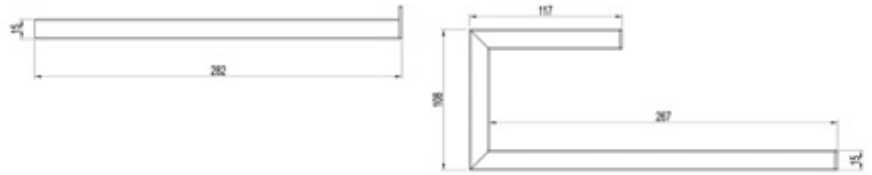

(compatibile anche con art.5152)
(compatible also with article 5152)
(compatible également avec l'article 5152)
(auch kompatibel mit Artikel 5152)

Verniciato bianco
Painted white
laqué blanc
Lackiertem Weiß

Verniciato nero
Painted black
laqué noir
Lackiertem Schwarz

Acciaio inox
Stainless steel
Acier inoxydable
Edelstahl

Acciaio inox satinato
Satinated stainless steel
Acier inoxydable satiné
Vereist Edelstahl

Bronzo spazzolato
Brushed bronze
Bronze brossée
Bronze gebürstet

Rosa metallizzato
Metallic pink matt
Rose métallisé mat
Metallic-Rosa matt

new

| | | | | | | |
|--------------|------------|------------|------------|------------|------------|------------|
| 51725 | .09 | .23 | .29 | .32 | .35 | .55 |
| € | 110,00 | 110,00 | 135,00 | 148,00 | 175,00 | 175,00 |



Dosapone in melamina 250 ml

Melamine soap dispenser 250 ml / Distributeur savon liquide en mélamine 250 ml / Melamine Seifenspender 250 ml

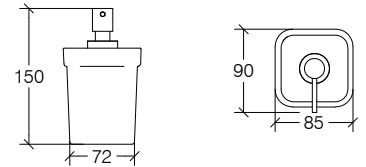

Verniciato bianco
Painted white
laqué blanc
Lackiertem Weiß

Verniciato nero
Painted black
laqué noir
Lackiertem Schwarz

Acciaio inox
Stainless steel
Acier inoxydable
Edelstahl

Bronzo spazzolato
Brushed bronze
Bronze brossée
Bronze gebürstet

Rosa metallizzato
Metallic pink matt
Rose métallisé mat
Metallic-Rosa matt

| | | | | | |
|-------------|------------|------------|------------|------------|------------|
| 5152 | .09 | .23 | .29 | .35 | .55 |
| € | 66,00 | 66,00 | 66,00 | 95,00 | 95,00 |

Portaspazzolini in melamina

Melamine toothbrush holder / Porte-brosses à dents en mélamine / Melamine Zahnpfutzbecher

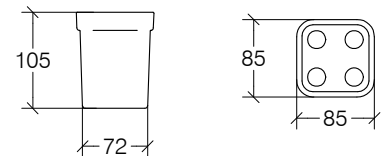

Verniciato bianco
Painted white
laqué blanc
Lackiertem Weiß

Verniciato nero
Painted black
laqué noir
Lackiertem Schwarz

Acciaio inox
Stainless steel
Acier inoxydable
Edelstahl

Bronzo spazzolato
Brushed bronze
Bronze brossée
Bronze gebürstet

Rosa metallizzato
Metallic pink matt
Rose métallisé mat
Metallic-Rosa matt

| | | | | | |
|-------------|------------|------------|------------|------------|------------|
| 5146 | .09 | .23 | .29 | .35 | .55 |
| € | 44,00 | 44,00 | 44,00 | 65,00 | 65,00 |

GRELA

Portasapone in melamina

Melamine soap dish / Porte-savon en mélamine / Melamine Seifenschale

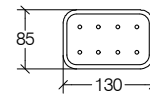
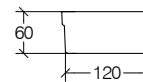

Verniciato bianco
Painted white
laqué blanc
Lackiertem Weiß



Verniciato nero
Painted black
laqué noir
Lackiertem Schwarz



Acciaio inox
Stainless steel
Acier inoxydable
Edelstahl



Bronzo spazzolato
Brushed bronze
Bronze brossé
Bronze gebürstet



Rosa metallizzato
Metallic pink matt
Rose métallisé mat
Metallic-Rosa matt



| | | | | | |
|-------------|------------|------------|------------|------------|------------|
| 5147 | .09 | .23 | .29 | .35 | .55 |
| € | 44,00 | 44,00 | 44,00 | 65,00 | 65,00 |

Scatola portaoggetti in melamina

Melamine box / Boîte porte-objets en mélamine / Melamine Schale

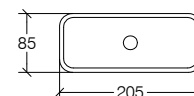
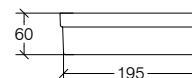

Verniciato bianco
Painted white
laqué blanc
Lackiertem Weiß



Verniciato nero
Painted black
laqué noir
Lackiertem Schwarz



Acciaio inox
Stainless steel
Acier inoxydable
Edelstahl



Bronzo spazzolato
Brushed bronze
Bronze brossé
Bronze gebürstet



Rosa metallizzato
Metallic pink matt
Rose métallisé mat
Metallic-Rosa matt



| | | | | | |
|-------------|------------|------------|------------|------------|------------|
| 5148 | .09 | .23 | .29 | .35 | .55 |
| € | 48,00 | 48,00 | 48,00 | 70,00 | 70,00 |

Mensola d'appoggio in melamina 290 mm

Melamine shelf 290 mm / Étagère en mélamine 290 mm / Melamine Konsole 290 mm

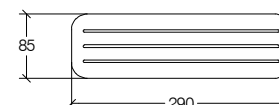
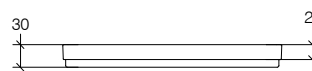

Metacrilato
Methacrylate
Méthacrylate
Methacrylat



| | |
|-------------|------------|
| 5153 | .09 |
| € | 38,00 |

GRELA

Piantana portasalviette

Towel holder stand / Porte-serviettes sur pied / Handtuchständer

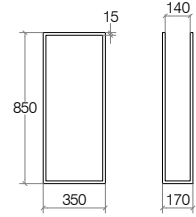

Verniciato bianco
Painted white
laqué blanc
Lackiertem Weiß



Verniciato nero
Painted black
laqué noir
Lackiertem Schwarz



Acciaio inox lucido
Polished stainless steel
Acier inoxydable brillant
Polierter Edelstahl



Bronzo spazzolato
Brushed bronze
Bronze brossée
Bronze gebürstet



Rosa metallizzato
Metallic pink matt
Rose métallisé mat
Metallic-Rosa matt



new

| | | | | | |
|-------------|------------|------------|------------|------------|------------|
| 5117 | .09 | .23 | .29 | .35 | .55 |
| € | 361,00 | 361,00 | 434,00 | 595,00 | 595,00 |

Piantana portarotolo e portascopino

Toilet paper and brush holder stand / Porte-rouleau sur pied avec porte-balais / Kombi-Bürstengarnitur

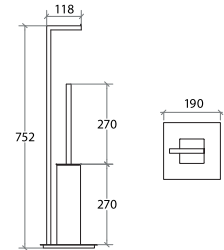

Verniciato bianco
Painted white
laqué blanc
Lackiertem Weiß



Verniciato nero
Painted black
laqué noir
Lackiertem Schwarz



Acciaio inox lucido
Polished stainless steel
Acier inoxydable brillant
Polierter Edelstahl



Bronzo spazzolato
Brushed bronze
Bronze brossée
Bronze gebürstet



Rosa metallizzato
Metallic pink matt
Rose métallisé mat
Metallic-Rosa matt



new

| | | | | | |
|-------------|------------|------------|------------|------------|------------|
| 5116 | .09 | .23 | .29 | .35 | .55 |
| € | 386,00 | 386,00 | 458,00 | 635,00 | 635,00 |

Portascopino da pavimento e a parete

Floor and wall toilet brush holder / Porte-balai mural ou à poser / Wand oder Boden WC Bürstengarnitur

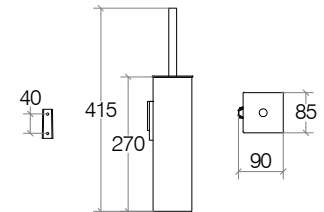

Verniciato bianco
Painted white
laqué blanc
Lackiertem Weiß



Verniciato nero
Painted black
laqué noir
Lackiertem Schwarz



Acciaio inox lucido
Polished stainless steel
Acier inox brillant
Glänzender Edelstahl



Acciaio inox satinato
Satinated stainless steel
Acier inox satiné
Vereist Edelstahl



Bronzo spazzolato
Brushed bronze
Bronze brossée
Bronze gebürstet



Rosa metallizzato
Metallic pink matt
Rose métallisé mat
Metallic-Rosa matt



50056

| | | | | | |
|------------|------------|------------|------------|------------|------------|
| .09 | .23 | .29 | .32 | .35 | .55 |
| € | 133,00 | 133,00 | 140,00 | 140,00 | 185,00 |

DADO

ACCESSORI _ Accessories _ Accessoires _ Accessoires



DADO: oggetto dalla forma quadrata usato in molti giochi da tavolo.

La collezione di accessori dal design geometrico e minimale, frutto di linee rigorose e angoli squadrati, in grado di caratterizzare l'ambiente bagno.

DADO è perfettamente abbinabile alla collezioni **DOLCEVITA**

EN

DADO: square shaped object used in many board games.

A new collection of accessories with a geometric and minimal design, which consists of rigorous lines and squared corners able to give a distinct character to the bathroom.

DADO perfectly complements the **DOLCEVITA** collection

FR

DADO : c'est le dé, utilisé dans de nombreux jeux de société.

Nouvelle collection d'accessoires aux lignes carrées et au style moderne et minimaliste. Un impact visuel fort, une beauté discrète mais que l'on perçoit au premier coup d'œil.

DADO s'harmonise parfaitement avec la collection **DOLCEVITA**

DE

DADO: zu Deutsch "Würfel", ein quadratisch geformtes Objekt also, das bei vielen Gesellschaftsspielen Verwendung findet.

Neue Zubehörkollektion mit einem geometrischen Minimaldesign aus strengen Linien und kantigen Ecken, das dem Bad ihren Stempel aufdrückt.

DADO passt perfekt zur **DOLCEVITA**-Kollektion









FINITURE _ Finishes _ Finitions _ Ausführung

Ottone cromato o verniciato

Chromed or painted brass

Laiton chromé ou laqué

Verchromter oder lackierter Messing

| | | | | | | | |
|---|--|--|---|--|--|--|---|
| <p>Metallo cromo Chromed metal Métal chromé Chrom Metall</p>  <p>.29</p> | <p>Metallo satinato Satinated metal Métal satiné Vereist Metall</p>  <p>.36</p> | <p>Verniciato nero opaco Matt painted black laqué noir mat Mattschwarz lackiertes</p>  <p>.23</p> | <p>Metallo oro rosa Pink gold metal Métal or rose Rotgold Metall</p>  <p>.34</p> | <p>Metallo oro Gold metal Métal or Gold Metall</p>  <p>.30</p> | <p>Metallo bronzo Bronze metal Métal bronze Bronze Metall</p>  <p>.35</p> | <p>Metallo oro spazzolato Gilded brushed Doré brossé Gold Gebürstetes</p>  <p>.37</p> | <p>Gun Metal spazzolato Gun Metal brushed Gun Metal brossé Gun Metal Gebürstetes</p>  <p>.38</p> |
|---|--|--|---|--|--|--|---|

Fissaggio con viti a muro o kit incollo _ Screwed to the wall or adhesive kit _ Fixation au mur avec vis ou kit d'adhésif _ Wandbefestigung mit Schrauben Klebeset



DADO

Kit incollo. Include colla bicomponente a posa rapida (kit opzionale) .

Adhesive kit. Includes fast-setting two-component adhesive (optional kit)

Kit d'adhésif. Comprend une colle bicomposante à prise rapide (kit optionnel)

Klebeset. Enthält schnellhärtenden Zweikomponentenklebstoff (optionales Set).

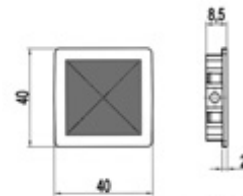

Metallo cromo
Chromed metal
Métal chromé
Chrom Metall

Verniciato nero opaco
Matt painted black
Laqué noir mat
Mattschwarz lackiertes

new

R612K

.29

.23

€

15,00

17,00



Portarotolo

Toilet paper holder / Porte-rouleau / Toilettenpapierhalter

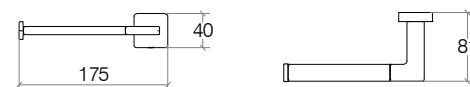

Metallo cromo
Chromed metal
Métal chromé
Chrom Metall

Metallo satinato
Satinated metal
Métal satiné
Vereist Metall

Verniciato nero opaco
Matt painted black
Laqué noir mat
Mattschwarz lackiertes

Metallo oro rosa
Pink gold metal
Métal or rose
Rotgold Metall

Metallo oro
Gold metal
Métal or
Gold Metall

Metallo bronzo
Bronze metal
Métal bronze
Bronze Metall

Metallo oro spazzolato
Gilded brushed
Doré brossé
Gold Gebürstetes

Gun Metal spazzolato
Gun Metal brushed
Gun Metal brossé
Gun Metal Gebürstetes



61204

.29

.36

.23

.34

.30

.35

.37

.38

€

52,00

72,00

60,00

75,00

73,00

75,00

86,00

86,00



Portarotolo coperto

Toilet paper holder with lid / Porte-rouleau avec couvercle / Toilettenpapierhalter mit Deckel

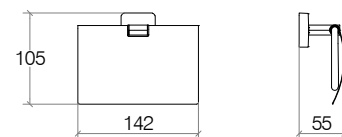

Metallo cromo
Chromed metal
Métal chromé
Chrom Metall

Metallo satinato
Satinated metal
Métal satiné
Vereist Metall

Verniciato nero opaco
Matt painted black
Laqué noir mat
Mattschwarz lackiertes

Metallo oro rosa
Pink gold metal
Métal or rose
Rotgold Metall

Metallo oro
Gold metal
Métal or
Gold Metall

Metallo bronzo
Bronze metal
Métal bronze
Bronze Metall

Metallo oro spazzolato
Gilded brushed
Doré brossé
Gold Gebürstetes

Gun Metal spazzolato
Gun Metal brushed
Gun Metal brossé
Gun Metal Gebürstetes



61205

.29

.36

.23

.34

.30

.35

.37

.38

€

71,00

99,00

84,00

111,00

107,00

111,00

118,00

118,00



Portarotolo con riserva

Toilet paper holder with reserve / Porte-rouleau réserve / Toilettenpapier Ersatzrollenhalter

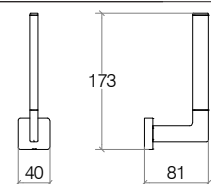

Metallo cromo
Chromed metal
Métal chromé
Chrom Metall

Metallo satinato
Satinated metal
Métal satiné
Vereist Metall

Verniciato nero opaco
Matt painted black
laqué noir mat
Mattschwarz lackiertes

Metallo oro rosa
Pink gold metal
Métal or rose
Rotgold Metall

Metallo oro
Gold metal
Métal or
Gold Metall

Metallo bronzo
Bronze metal
Métal bronze
Bronze Metall

Metallo oro spazzolato
Gilded brushed
Doré brossé
Gold Gebürstetes

Gun Metal spazzolato
Gun Metal brushed
Gun Metal brossé
Gun Metal Gebürstetes



61206

.29

.36

.23

.34

.30

.35

.37

.38

€

50,00

70,00

57,00

75,00

73,00

75,00

83,00

83,00



DADO

DADO

Coppia appendini

2 Hooks / Jeu de 2 patères / Paar Hacken

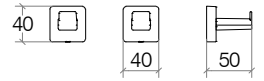

| | Metallo cromo Chromed metal Métal chromé Chrom Metall | Metallo satinato Satinated metal Métal satiné Vereist Metall | Verniciato nero opaco Matt painted black laqué noir mat Mattschwarz lackiertes | Metallo oro rosa Pink gold metal Métal or rose Rotgold Metall | Metallo oro Gold metal Métal or Gold Metall | Metallo bronzo Bronze metal Métal bronze Bronze Metall | Metallo oro spazzolato Gilded brushed Doré brossé Gold Gebürstetes | Gun Metal spazzolato Gun Metal brushed Gun Metal brossé Gun Metal Gebürstetes |
|--------------|---|--|---|---|---|--|--|---|
| 61207 | .29 | .36 | .23 | .34 | .30 | .35 | .37 | .38 |
| € | 50,00 | 70,00 | 57,00 | 74,00 | 72,00 | 74,00 | 83,00 | 83,00 |

Portasalvietta 340 mm

Towel rail 340 mm / Porte-serviettes 340 mm / Handtuchhalter 340 mm



| | Metallo cromo Chromed metal Métal chromé Chrom Metall | Metallo satinato Satinated metal Métal satiné Vereist Metall | Verniciato nero opaco Matt painted black laqué noir mat Mattschwarz lackiertes | Metallo oro rosa Pink gold metal Métal or rose Rotgold Metall | Metallo oro Gold metal Métal or Gold Metall | Metallo bronzo Bronze metal Métal bronze Bronze Metall | Metallo oro spazzolato Gilded brushed Doré brossé Gold Gebürstetes | Gun Metal spazzolato Gun Metal brushed Gun Metal brossé Gun Metal Gebürstetes |
|--------------|---|--|---|---|---|--|--|---|
| 61208 | .29 | .36 | .23 | .34 | .30 | .35 | .37 | .38 |
| € | 75,00 | 104,00 | 84,00 | 112,00 | 108,00 | 112,00 | 125,00 | 125,00 |

Portasalvietta 490 mm

Towel rail 490 mm / Porte-serviettes 490 mm / Handtuchhalter 490 mm

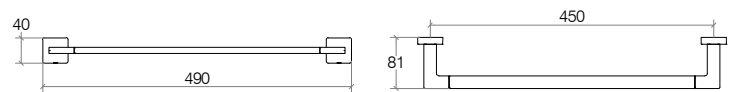

| | Metallo cromo Chromed metal Métal chromé Chrom Metall | Metallo satinato Satinated metal Métal satiné Vereist Metall | Verniciato nero opaco Matt painted black laqué noir mat Mattschwarz lackiertes | Metallo oro rosa Pink gold metal Métal or rose Rotgold Metall | Metallo oro Gold metal Métal or Gold Metall | Metallo bronzo Bronze metal Métal bronze Bronze Metall | Metallo oro spazzolato Gilded brushed Doré brossé Gold Gebürstetes | Gun Metal spazzolato Gun Metal brushed Gun Metal brossé Gun Metal Gebürstetes |
|--------------|---|--|---|---|---|--|--|---|
| 61209 | .29 | .36 | .23 | .34 | .30 | .35 | .37 | .38 |
| € | 81,00 | 110,00 | 95,00 | 119,00 | 115,00 | 119,00 | 138,00 | 138,00 |

Portasalvietta 640 mm

Towel rail 640 mm / Porte-serviettes 640 mm / Handtuchhalter 640 mm

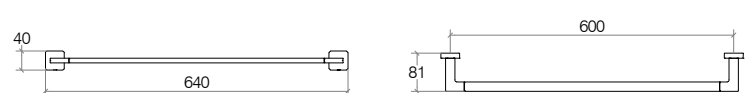

| | Metallo cromo Chromed metal Métal chromé Chrom Metall | Metallo satinato Satinated metal Métal satiné Vereist Metall | Verniciato nero opaco Matt painted black laqué noir mat Mattschwarz lackiertes | Metallo oro rosa Pink gold metal Métal or rose Rotgold Metall | Metallo oro Gold metal Métal or Gold Metall | Metallo bronzo Bronze metal Métal bronze Bronze Metall | Metallo oro spazzolato Gilded brushed Doré brossé Gold Gebürstetes | Gun Metal spazzolato Gun Metal brushed Gun Metal brossé Gun Metal Gebürstetes |
|--------------|---|--|---|---|---|--|--|---|
| 61210 | .29 | .36 | .23 | .34 | .30 | .35 | .37 | .38 |
| € | 92,00 | 129,00 | 107,00 | 137,00 | 132,00 | 137,00 | 153,00 | 153,00 |

DADO

Portasalviette 840 mm

Towel rail 840 mm / Porte-serviettes 840 mm / Handtuchhalter 840 mm



| | | | | | | | |
|---|--|---|---|---|--|--|---|
| Metallo cromo Chromed metal Métal chromé Chrom Metall | Metallo satinato Satinated metal Métal satiné Vereist Metall | Verniciato nero opaco Matt painted black laqué noir mat Mattschwarz lackiertes | Metallo oro rosa Pink gold metal Métal or rose Rotgold Metall | Metallo oro Gold metal Métal or Gold Metall | Metallo bronzo Bronze metal Métal bronze Bronze Metall | Metallo oro spazzolato Gilded brushed Doré brossé Gold Gebürstetes | Gun Metal spazzolato Gun Metal brushed Gun Metal brossé Gun Metal Gebürstetes |
|---|--|---|---|---|--|--|---|

| | | | | | | | | |
|--------------|------------|------------|------------|------------|------------|------------|------------|------------|
| 61211 | .29 | .36 | .23 | .34 | .30 | .35 | .37 | .38 |
| € | 106,00 | 160,00 | 122,00 | 167,00 | 161,00 | 167,00 | 175,00 | 175,00 |



Portasalviette doppio 640 mm

Double towel holder 640 mm / Porte-serviettes double 640 mm / Doppelhandtuchhalter 640 mm

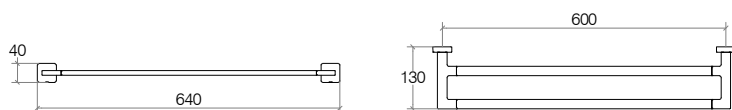

| | | | | | | | |
|---|--|---|---|---|--|--|---|
| Metallo cromo Chromed metal Métal chromé Chrom Metall | Metallo satinato Satinated metal Métal satiné Vereist Metall | Verniciato nero opaco Matt painted black laqué noir mat Mattschwarz lackiertes | Metallo oro rosa Pink gold metal Métal or rose Rotgold Metall | Metallo oro Gold metal Métal or Gold Metall | Metallo bronzo Bronze metal Métal bronze Bronze Metall | Metallo oro spazzolato Gilded brushed Doré brossé Gold Gebürstetes | Gun Metal spazzolato Gun Metal brushed Gun Metal brossé Gun Metal Gebürstetes |
|---|--|---|---|---|--|--|---|

| | | | | | | | | |
|--------------|------------|------------|------------|------------|------------|------------|------------|------------|
| 61212 | .29 | .36 | .23 | .34 | .30 | .35 | .37 | .38 |
| € | 154,00 | 220,00 | 175,00 | 233,00 | 224,00 | 233,00 | 251,00 | 251,00 |



Portasalviette snodato

Jointed towel rail / Porte-serviettes articulé / Handtuchhalter schwenkbar

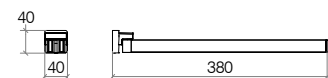

Metallo cromo
Chromed metal
Métal chromé
Chrom Metall

| | |
|--------------|------------|
| 61213 | .29 |
| € | 112,00 |



Portasalviette

Towel rail / Porte-serviettes / Handtuchhalter

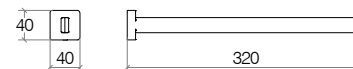

| | | | | | | | |
|---|--|---|---|---|--|--|---|
| Metallo cromo Chromed metal Métal chromé Chrom Metall | Metallo satinato Satinated metal Métal satiné Vereist Metall | Verniciato nero opaco Matt painted black laqué noir mat Mattschwarz lackiertes | Metallo oro rosa Pink gold metal Métal or rose Rotgold Metall | Metallo oro Gold metal Métal or Gold Metall | Metallo bronzo Bronze metal Métal bronze Bronze Metall | Metallo oro spazzolato Gilded brushed Doré brossé Gold Gebürstetes | Gun Metal spazzolato Gun Metal brushed Gun Metal brossé Gun Metal Gebürstetes |
|---|--|---|---|---|--|--|---|

| | | | | | | | | |
|--------------|------------|------------|------------|------------|------------|------------|------------|------------|
| 61214 | .29 | .36 | .23 | .34 | .30 | .35 | .37 | .38 |
| € | 48,00 | 70,00 | 56,00 | 74,00 | 72,00 | 74,00 | 95,00 | 95,00 |



DADO

DADO

Anello portasalviette

Towel ring / Anneau porte-serviettes / Handtuchring

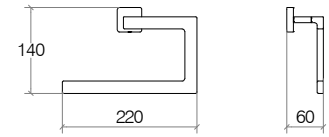

| | Metallo cromo Chromed metal Métal chromé Chrom Metall | Metallo satinato Satinated metal Métal satiné Vereist Metall | Verniciato nero opaco Matt painted black laqué noir mat Mattschwarz lackiertes | Metallo oro rosa Pink gold metal Métal or rose Rotgold Metall | Metallo oro Gold metal Métal or Gold Metall | Metallo bronzo Bronze metal Métal bronze Bronze Metall | Metallo oro spazzolato Gilded brushed Doré brossé Gold Gebürstetes | Gun Metal spazzolato Gun Metal brushed Gun Metal brossé Gun Metal Gebürstetes |
|--------------|---|--|---|---|---|--|--|---|
| 61215 | .29 | .36 | .23 | .34 | .30 | .35 | .37 | .38 |
| € | 70,00 | 94,00 | 78,00 | 101,00 | 97,00 | 101,00 | 115,00 | 115,00 |

Supporto singolo

Single holder / Support individuel / Einzelhalter

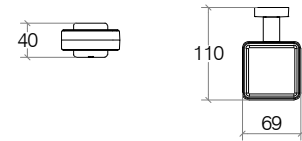

| | Metallo cromo Chromed metal Métal chromé Chrom Metall | Metallo satinato Satinated metal Métal satiné Vereist Metall | Verniciato nero opaco Matt painted black laqué noir mat Mattschwarz lackiertes | Metallo oro rosa Pink gold metal Métal or rose Rotgold Metall | Metallo oro Gold metal Métal or Gold Metall | Metallo bronzo Bronze metal Métal bronze Bronze Metall | Metallo oro spazzolato Gilded brushed Doré brossé Gold Gebürstetes | Gun Metal spazzolato Gun Metal brushed Gun Metal brossé Gun Metal Gebürstetes |
|--------------|---|--|---|---|---|--|--|---|
| 61201 | .29 | .36 | .23 | .34 | .30 | .35 | .37 | .38 |
| € | 30,00 | 50,00 | 39,00 | 54,00 | 52,00 | 54,00 | 60,00 | 60,00 |

Supporto doppio

Double holder / Support double / Doppelhalter

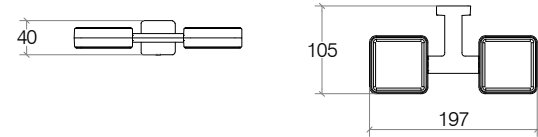

| | Metallo cromo Chromed metal Métal chromé Chrom Metall | Metallo satinato Satinated metal Métal satiné Vereist Metall | Verniciato nero opaco Matt painted black laqué noir mat Mattschwarz lackiertes | Metallo oro rosa Pink gold metal Métal or rose Rotgold Metall | Metallo oro Gold metal Métal or Gold Metall | Metallo bronzo Bronze metal Métal bronze Bronze Metall | Metallo oro spazzolato Gilded brushed Doré brossé Gold Gebürstetes | Gun Metal spazzolato Gun Metal brushed Gun Metal brossé Gun Metal Gebürstetes |
|--------------|---|--|---|---|---|--|--|---|
| 61202 | .29 | .36 | .23 | .34 | .30 | .35 | .37 | .38 |
| € | 45,00 | 76,00 | 56,00 | 96,00 | 92,00 | 96,00 | 100,00 | 100,00 |

Ghiera per accessori da appoggio serie 'Dado'

Tabletop ring for 'Dado' accessories / Anneau de support pour accessoires 'Dado' / Ring für Accessories Serie 'Dado'

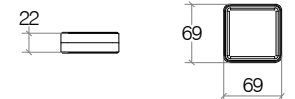

| | Metallo cromo Chromed metal Métal chromé Chrom Metall | Metallo satinato Satinated metal Métal satiné Vereist Metall | Verniciato nero opaco Matt painted black laqué noir mat Mattschwarz lackiertes | Metallo oro rosa Pink gold metal Métal or rose Rotgold Metall | Metallo oro Gold metal Métal or Gold Metall | Metallo bronzo Bronze metal Métal bronze Bronze Metall | Metallo oro spazzolato Gilded brushed Doré brossé Gold Gebürstetes | Gun Metal spazzolato Gun Metal brushed Gun Metal brossé Gun Metal Gebürstetes |
|--------------|---|--|---|---|---|--|--|---|
| 61203 | .29 | .36 | .23 | .34 | .30 | .35 | .37 | .38 |
| € | 38,00 | 52,00 | 42,00 | 56,00 | 54,00 | 56,00 | 60,00 | 60,00 |

DADO

Dosasapone con leva 150 ml con supporto a muro

Wall soap dispenser with lever 150 ml / Distributeur savon liquide mural avec levier 150 ml / Wandseifenspender mit Hebel 150 ml

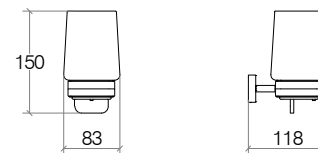

Ceramica
Ceramic
C eramique
Keramik

Metallo cromo
Chromed metal
M tal chrom 
Chrom Metall



Metallo satinato
Satinated metal
M tal satin 
Vereist Metall



Metallo nero opaco
Matt black metal
M tal noir mat
Schwarz Matt Metall



Metallo oro rosa
Pink gold metal
M tal or rose
Rotgold Metall



Metallo oro
Gold metal
M tal or
Gold Metall



Metallo bronzo
Bronze metal
M tal bronze
Bronze Metall



Metallo oro spazzolato
Gilded brushed
Dor  bross 
Gold Geb rstetes



Gun Metal spazzolato
Gun Metal brushed
Gun Metal bross 
Gun Metal Geb rstetes



61216.XX.09

.29

.36

.23

.34

.30

.35

.37

.38

€

90,00

123,00

103,00

132,00

127,00

132,00

148,00

148,00



Bicchieri

Tumbler / Verre / Becher

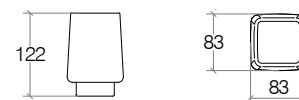

Ceramica
Ceramic
C eramique
Keramik



61221

.09

€

38,00



Portasapone

Soap dish / Porte-savon / Seifenschale



Ceramica
Ceramic
C eramique
Keramik



61222

.09

€

32,00



Dosasapone 250 ml

Soap dispenser 250 ml / Distributeur savon liquide 250 ml / Seifenspender 250 ml

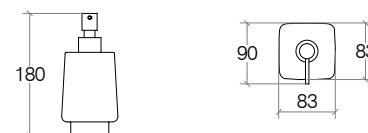

Ceramica
Ceramic
C eramique
Keramik

Metallo cromo
Chromed metal
M tal chrom 
Chrom Metall



Metallo satinato
Satinated metal
M tal satin 
Vereist Metall



Verniciato nero opaco
Matt painted black
laqu  noir mat
Mattschwarz
lackiertes



Metallo oro rosa
Pink gold metal
M tal or rose
Rotgold Metall



Metallo oro
Gold metal
M tal or
Gold Metall



Metallo bronzo
Bronze metal
M tal bronze
Bronze Metall



Metallo oro spazzolato
Gilded brushed
Dor  bross 
Gold Geb rstetes



Gun Metal spazzolato
Gun Metal brushed
Gun Metal bross 
Gun Metal Geb rstetes



61223.XX.09

61223.09

.36

.23

.34

.30

.35

.37

.38

€

60,00

87,00

76,00

94,00

90,00

94,00

100,00

100,00



Portascopino da pavimento e a parete

Floor and wall toilet brush holder / Porte-balai mural ou à poser / Wand oder Boden WC Bürstengarnitur

DADO

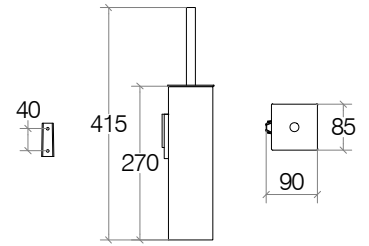

**Verniciato
nero opaco**
Painted black
laqué noir
Lackiertem
Schwarz



**Acciaio
inox lucido**
Polished
stainless steel
Acier inox brillant
Glänzer Edelstahl



**Acciaio
inox satinato**
Satinated
stainless steel
Acier inox satiné
Vereist Edelstahl



**Metallo
bronzo**
Bronze metal
Métal bronze
Bronze Metall



**Metallo oro
spazzolato**
Gilded brushed
Doré brossé
Gold Gebürstetes



**Gun Metal
spazzolato**
Gun Metal brushed
Gun Metal brossé
Gun Metal
Gebürstetes



| | | | | | | |
|--------------|------------|------------|------------|------------|------------|------------|
| 50056 | .23 | .29 | .32 | .35 | .37 | .38 |
| € | 133,00 | 140,00 | 140,00 | 185,00 | 185,00 | 185,00 |

ROERSA

ACCESSORI _ Accessories _ Accessoires _ Accessoires



ROERSA: rovesciata - capovolta.

Questa collezione, viene proposta in acciaio inox AISI 316, inalterabile nel tempo.

Interessanti le mensole-griglia, perfette per dotare l'ambiente doccia con portaoggetti non banali.

EN

ROERSA: overturned, upside-down.

This collection, is offered in AISI 316 stainless steel, a material that does not change over time. The grid shelves are intriguing and ideal for equipping the shower room with original storage places.

FR

ROERSA : à l'envers, renversée.

Cette collection, est proposée en acier inox AISI 316, inaltérable dans le temps. Les étagères avec grille sont idéales pour équiper l'espace-douche d'un porte-objets original.

DE

ROERSA: umgekehrt, umgedreht.

Diese Kollektion, wird in alterungsbeständigem Edelstahl AISI 316 angeboten. Interessant die Gitterkonsolen, die ideal sind, um die Dusche mit beileibe nicht alltäglichen Ablagen auszustatten.

FINITURE / Finishes / Finitions / Ausführung:**Acciaio AISI 316 lucido o satinato con inserti in melamina**

Polished or satin-finished AISI 316 steel with melamine inserts

Acier AISI 316 brillant ou satiné avec accessoires en mélamine

Stahl AISI 316 glänzend oder satiniert mit Melanineinsätzen

Acciaio AISI 316 lucido

Polished AISI 316 steel

Acier AISI 316 brillant

Stahl AISI 316 glänzend

**.29****Acciaio AISI 316 satinato**

Satined AISI 316 steel

Acier AISI 316 satiné

Stahl AISI 316 satiniert

**.32**

Fissaggio con viti a muro _ Screwed to the wall _ Fixation au mur avec vis _ Wandbefestigung mit Schrauben



ROERSA

Portarotolo

Toilet paper holder / Porte-rouleau / Toilettenpapierhalter

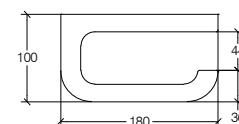
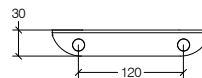

Acciaio inox lucido
Polished stainless steel
Acier inoxydable brillant
Poliert Edelstahl

Acciaio inox satinato
Satinated stainless steel
Acier inoxydable satiné
Vereist Edelstahl



5161

.29

.32

€

114,00

114,00



Appendino doppio

Double hook / Patère double / Hacken doppelt

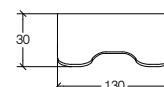
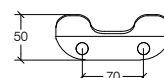

Acciaio inox lucido
Polished stainless steel
Acier inoxydable brillant
Poliert Edelstahl

Acciaio inox satinato
Satinated stainless steel
Acier inoxydable satiné
Vereist Edelstahl



5160

.29

.32

€

114,00

114,00



Portasalvietta / Porta accessori 460 mm

Towel holder accessories bar 460 mm / Porte-serviettes - support pour accessoires (à équiper) 460 mm
Handtuchhalter Halter für Accessoires 460 mm

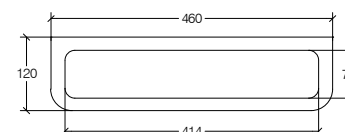
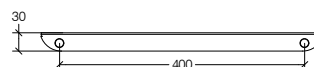

Acciaio inox lucido
Polished stainless steel
Acier inoxydable brillant
Poliert Edelstahl

Acciaio inox satinato
Satinated stainless steel
Acier inoxydable satiné
Vereist Edelstahl



5164

.29

.32

€

167,00

167,00



Portasalvietta / Porta accessori 640 mm

Towel holder accessories bar 640 mm / Porte-serviettes - support pour accessoires (à équiper) 640 mm
Accessoires und Handtuchhalter 640 mm

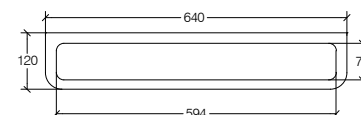
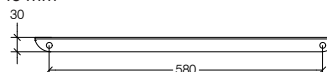

Acciaio inox lucido
Polished stainless steel
Acier inoxydable brillant
Poliert Edelstahl

Acciaio inox satinato
Satinated stainless steel
Acier inoxydable satiné
Vereist Edelstahl



5165

.29

.32

€

202,00

202,00



Supporto con mensola 800 mm, foro sx

Towel holder and accessories bar 800 mm, left hole / Etagère avec p.serviettes - support pour accessoires 800 mm, trou à gauche
Halter mit Ablage 800 mm Loch Links

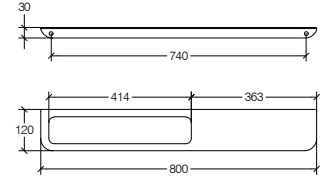

Acciaio inox lucido
Polished stainless steel
Acier inoxydable brillant
Poliert Edelstahl

Acciaio inox satinato
Satinated stainless steel
Acier inoxydable satiné
Vereist Edelstahl



| | | |
|-------------|------------|------------|
| 5169 | .29 | .32 |
| € | 239,00 | 239,00 |

Mensola doccia angolare 200 mm

Shower shelf corner 200 mm / Etagère douche angulaire 200 mm / Duschablage eckig 200 mm

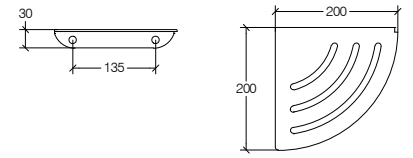
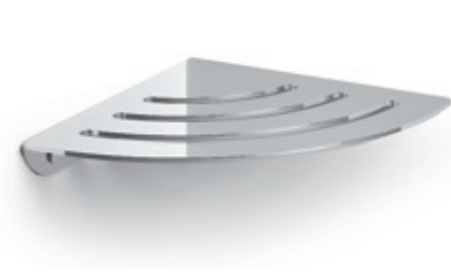

Acciaio inox lucido
Polished stainless steel
Acier inoxydable brillant
Poliert Edelstahl

Acciaio inox satinato
Satinated stainless steel
Acier inoxydable satiné
Vereist Edelstahl



| | | |
|-------------|------------|------------|
| 5170 | .29 | .32 |
| € | 140,00 | 140,00 |

Mensola doccia 300 mm

Shower shelf 300 mm / Etagère douche 300 mm / Duschablage 300 mm

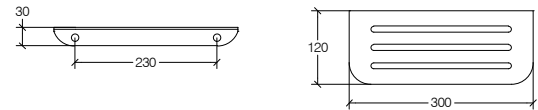

Acciaio inox lucido
Polished stainless steel
Acier inoxydable brillant
Poliert Edelstahl

Acciaio inox satinato
Satinated stainless steel
Acier inoxydable satiné
Vereist Edelstahl



| | | |
|-------------|------------|------------|
| 5171 | .29 | .32 |
| € | 148,00 | 148,00 |

Mensola doccia 600 mm

Shower shelf 600 mm / Etagère douche 600 mm / Duschablage 600 mm

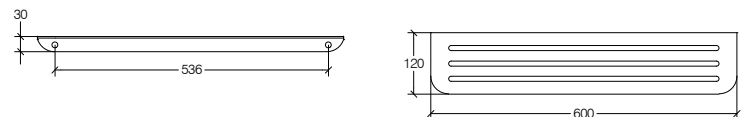
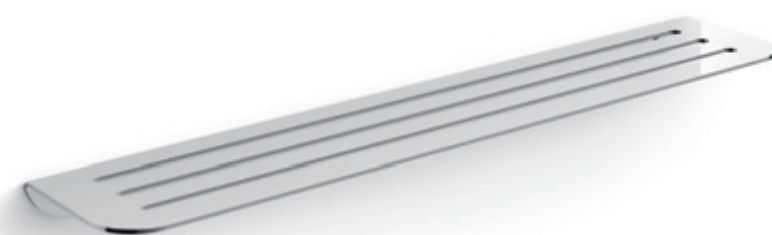

Acciaio inox lucido
Polished stainless steel
Acier inoxydable brillant
Poliert Edelstahl

Acciaio inox satinato
Satinated stainless steel
Acier inoxydable satiné
Vereist Edelstahl



| | | |
|-------------|------------|------------|
| 5172 | .29 | .32 |
| € | 216,00 | 216,00 |

ROERSA

Dosapone in melamina 250 ml

Melamine soap dispenser 250 ml / Distributeur savon liquide en mélamine 250 ml / Melamine Seifenspender 250 ml

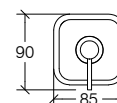
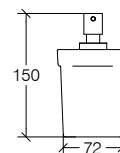

Verniciato bianco
Painted white
Laqué blanc
Lackiertem Weiß



Verniciato nero
Painted black
Laqué noir
Lackiertem Schwarz



Acciaio inox
Stainless steel
Acier inoxydable
Edelstahl



| | | | |
|-------------|------------|------------|------------|
| 5152 | .09 | .23 | .29 |
| € | 66,00 | 66,00 | 66,00 |

Portaspazzolini in melamina

Melamine toothbrush holder / Porte-brosses à dents en mélamine / Melamine Zahnpfutzbecher

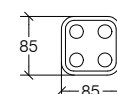
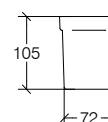

Verniciato bianco
Painted white
Laqué blanc
Lackiertem Weiß



Verniciato nero
Painted black
Laqué noir
Lackiertem Schwarz



Acciaio inox
Stainless steel
Acier inoxydable
Edelstahl



| | | | |
|-------------|------------|------------|------------|
| 5146 | .09 | .23 | .29 |
| € | 44,00 | 44,00 | 44,00 |

Portasapone in melamina

Melaminesoap dish / Porte-savon en mélamine / Melamine Seifenschale

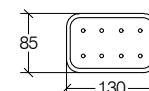
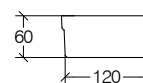

Verniciato bianco
Painted white
Laqué blanc
Lackiertem Weiß



Verniciato nero
Painted black
Laqué noir
Lackiertem Schwarz



Acciaio inox
Stainless steel
Acier inoxydable
Edelstahl



| | | | |
|-------------|------------|------------|------------|
| 5147 | .09 | .23 | .29 |
| € | 44,00 | 44,00 | 44,00 |

Scatola portaoggetti in melamina

Melamine box / Boîte porte-objets en mélamine / Melamine Schale

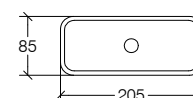
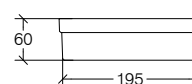

Verniciato bianco
Painted white
Laqué blanc
Lackiertem Weiß



Verniciato nero
Painted black
Laqué noir
Lackiertem Schwarz



Acciaio inox
Stainless steel
Acier inoxydable
Edelstahl



| | | | |
|-------------|------------|------------|------------|
| 5148 | .09 | .23 | .29 |
| € | 48,00 | 48,00 | 48,00 |

Mensola d'appoggio in melamina 290 mm

Melamine shelf 290 mm / Étagère en mélamine 290 mm / Melamine Konsole 290 mm

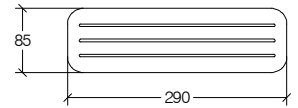
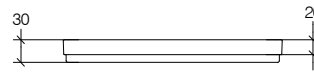

Metacrilato
Methacrylate
Méthacrylate
Methacrylat



| | |
|-------------|------------|
| 5153 | .09 |
| € | 38,00 |

Portascopino da pavimento e a parete

Floor and wall toilet brush holder / Porte-balai mural ou à poser / Wand oder Boden WC Bürstengarbitur

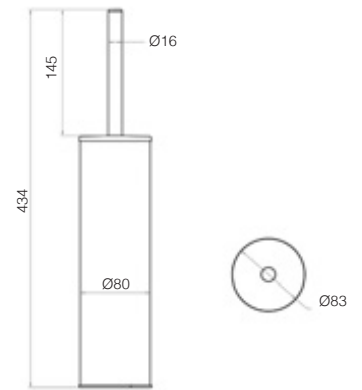

Acciaio inox lucido
Polished stainless steel
Acier inox brillant
Glänzer Edelstahl

Acciaio inox satinato
Satinated stainless steel
Acier inox satiné
Vereist Edelstahl



| | | |
|--------------|------------|------------|
| 50048 | .29 | .32 |
| € | 109,00 | 109,00 |



SAETA

ACCESSORI _ Accessories _ Accessoires _ Accessoires



SAETA: il fulmine, quella cosa che improvvisamente illumina il cielo e altrettanto improvvisamente scompare. Sottile, discreta ma nel contempo di carattere. Realizzata in alluminio verniciato, disponibile nei colori di tendenza.

SAETA è perfettamente abbinabile alla serie **ACRUX** di **SAMO**

EN

SAETA:

lightning, that thing that suddenly illuminates the sky and just as suddenly disappears.

Thin, discreet but at the same time with character. Made of painted aluminium, available in today's trendy colours.

SAETA perfectly complements the **ACRUX** series by **SAMO**

FR

SAETA :

la foudre, ce phénomène météorologique qui illumine soudainement le ciel et disparaît tout aussi rapidement.

Fine, discrète mais avec du caractère. En aluminium verni, disponible dans les couleurs tendances actuelles.

SAETA s'harmonise parfaitement avec la série **ACRUX** de **SAMO**

DE

SAETA:

der Blitz; das, was so plötzlich den Himmel erleuchtet und ebenso plötzlich wieder verschwindet.

Fein, unaufdringlich, gleichzeitig aber charaktervoll. Aus lackiertem Aluminium gefertigt, erhältlich in den derzeitigen Trendfarben.

SAETA passt perfekt zur **ACRUX**-Serie von **SAMO**

SAETA









FINITURE _ Finishes _ Finitions _ Ausführung:

Alluminio verniciato

Painted aluminium

Aluminium verni

Aluminium lackiert

| | | | | | |
|---|---|---|--|---|---|
| <p>Bianco opaco White matt Mat blanc Matt Weiß</p>  <p>.09</p> | <p>Nero opaco Black matt Mat noir Matt Schwarz</p>  <p>.23</p> | <p>Artic opaco Artic matt Mat Artic Matt Artic</p>  <p>.90</p> | | | |
| <p>Sailor blue opaco Sailor blue matt Mat Sailor blue Matt Sailor Blue</p>  <p>.92</p> | <p>Grigio opaco Grey matt Mat gris Matt Grau</p>  <p>.95</p> | <p>Sabbia opaco Sand matt Mat sable Matt Sand</p>  <p>.98</p> | <p>Tortora opaco Tortora matt Mat tortora Matt tortora</p>  <p>.99</p> | <p>Sage opaco Sage matt Mat sage Matt Sage</p>  <p>.73</p> | <p>Ambra opaco Ambra matt Mat ambra Matt Ambra</p>  <p>.86</p> |

Fissaggio con viti a muro _ Screwed to the wall _ Fixation au mur avec vis _ Wandbefestigung mit Schrauben



SAETA

Portarotolo

Toilet paper holder / Porte-rouleau / Toilettenpapierhalter

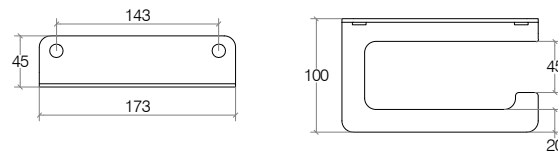

| | Bianco White Bkanc Weiß | Nero Black Noir Schwarz | Artic Artic Artic Artic | Sailor Blue Sailor blue Sailor blue Sailor blue | Grigio Grey Gris Grau | Sabbia Sand Sable Sand | Tortora Tortora Tortora Tortora | Sage Sage Sage Sage | Ambra Ambra Ambra Ambra |
|-------|----------------------------------|----------------------------------|----------------------------------|--|--------------------------------|---------------------------------|--|------------------------------|----------------------------------|
| 51811 | .09 | .23 | .90 | .92 | .95 | .98 | .99 | .73 | .86 |
| € | 39,00 | 39,00 | 39,00 | 39,00 | 39,00 | 39,00 | 39,00 | 39,00 | 39,00 |

Portarotolo con riserva in Mattstone

Mattstone toilet paper holder with supply / Porte-rouleau en Mattstone avec réserve / Mattstone Toilettenpapierhalter mit Reserve

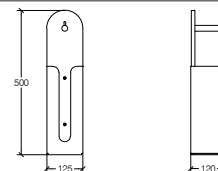

| | Bianco White Bkanc Weiß | Nero Black Noir Schwarz | Artic Artic Artic Artic | Sailor blue Sailor blue Sailor blue Sailor blue | Grigio Grey Gris Grau | Sabbia Sand Sable Sand | Tortora Tortora Tortora Tortora | Sage Sage Sage Sage | Ambra Ambra Ambra Ambra |
|------|----------------------------------|----------------------------------|----------------------------------|--|--------------------------------|---------------------------------|--|------------------------------|----------------------------------|
| 5135 | .09 | .23 | .90 | .92 | .95 | .98 | .99 | .73 | .86 |
| € | 159,00 | 159,00 | 159,00 | 159,00 | 159,00 | 159,00 | 159,00 | 159,00 | 159,00 |

Appendino doppio

Double hook / Patère double / Hacken doppelt

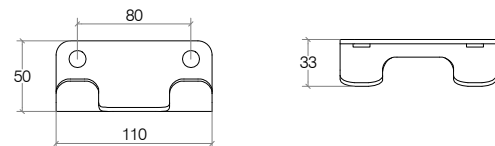

| | Bianco White Bkanc Weiß | Nero Black Noir Schwarz | Artic Artic Artic Artic | Sailor blue Sailor blue Sailor blue Sailor blue | Grigio Grey Gris Grau | Sabbia Sand Sable Sand | Tortora Tortora Tortora Tortora | Sage Sage Sage Sage | Ambra Ambra Ambra Ambra |
|-------|----------------------------------|----------------------------------|----------------------------------|--|--------------------------------|---------------------------------|--|------------------------------|----------------------------------|
| 51813 | .09 | .23 | .90 | .92 | .95 | .98 | .99 | .73 | .86 |
| € | 37,00 | 37,00 | 37,00 | 37,00 | 37,00 | 37,00 | 37,00 | 37,00 | 37,00 |

Portateli con 4 ganci appendiabiti

Carry them with 4 coat hooks / Transportez-les avec 4 patères / Tragen Sie sie mit 4 Kleiderhaken

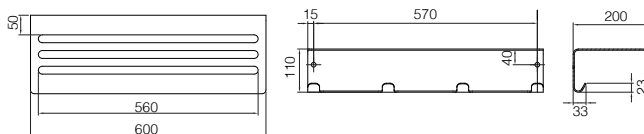

| | Bianco White Bkanc Weiß | Nero Black Noir Schwarz | Artic Artic Artic Artic | Sailor blue Sailor blue Sailor blue Sailor blue | Grigio Grey Gris Grau | Sabbia sand sable Sand | Tortora Tortora Tortora Tortora | Sage Sage Sage Sage | Ambra Ambra Ambra Ambra |
|---------------------|----------------------------------|----------------------------------|----------------------------------|--|--------------------------------|---------------------------------|--|------------------------------|----------------------------------|
| new 51821 | .09 | .23 | .90 | .92 | .95 | .98 | .99 | .73 | .86 |
| € | 140,00 | 140,00 | 140,00 | 140,00 | 140,00 | 140,00 | 140,00 | 140,00 | 140,00 |

Portasalviette 454 mm

Towel rail 454 mm / Porte-serviettes 454 mm / Handtuchhalter 454 mm

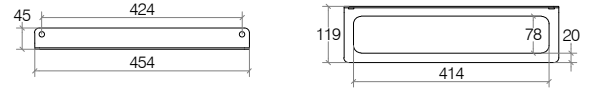

| 51815 | Bianco White Bkanc Weiß | Nero Black Noir Schwarz | Artic Artic Artic Artic | Sailor blue Sailor blue Sailor blue Sailor blue | Grigio Grey Gris Grau | Sabbia Sand Sable Sand | Tortora Tortora Tortora Tortora | Sage Sage Sage Sage | Ambra Ambra Ambra Ambra |
|-------|----------------------------------|----------------------------------|----------------------------------|--|--------------------------------|---------------------------------|--|------------------------------|----------------------------------|
| | .09 | .23 | .90 | .92 | .95 | .98 | .99 | .73 | .86 |
| € | 67,00 | 67,00 | 67,00 | 67,00 | 67,00 | 67,00 | 67,00 | 67,00 | 67,00 |

Portasalviette 634 mm

Towel rail 634 mm / Porte-serviettes 634 mm / Handtuchhalter 634 mm

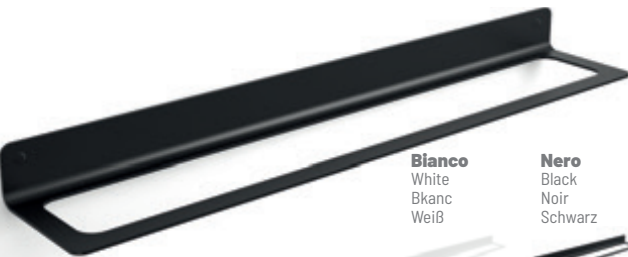

| 51816 | Bianco White Bkanc Weiß | Nero Black Noir Schwarz | Artic Artic Artic Artic | Sailor blue Sailor blue Sailor blue Sailor blue | Grigio Grey Gris Grau | Sabbia Sand Sable Sand | Tortora Tortora Tortora Tortora | Sage Sage Sage Sage | Ambra Ambra Ambra Ambra |
|-------|----------------------------------|----------------------------------|----------------------------------|--|--------------------------------|---------------------------------|--|------------------------------|----------------------------------|
| | .09 | .23 | .90 | .92 | .95 | .98 | .99 | .73 | .86 |
| € | 77,00 | 77,00 | 77,00 | 77,00 | 77,00 | 77,00 | 77,00 | 77,00 | 77,00 |

Mensola 454 mm

Shelf 454 mm / Tablette 454 mm / Ablage 454 mm



| 51817 | Bianco White Bkanc Weiß | Nero Black Noir Schwarz | Artic Artic Artic Artic | Sailor blue Sailor blue Sailor blue Sailor blue | Grigio Grey Gris Grau | Sabbia Sand Sable Sand | Tortora Tortora Tortora Tortora | Sage Sage Sage Sage | Ambra Ambra Ambra Ambra |
|-------|----------------------------------|----------------------------------|----------------------------------|--|--------------------------------|---------------------------------|--|------------------------------|----------------------------------|
| | .09 | .23 | .90 | .92 | .95 | .98 | .99 | .73 | .86 |
| € | 72,00 | 72,00 | 72,00 | 72,00 | 72,00 | 72,00 | 72,00 | 72,00 | 72,00 |

Mensola 634 mm

Shelf 634 mm / Tablette 634 mm / Ablage 634 mm

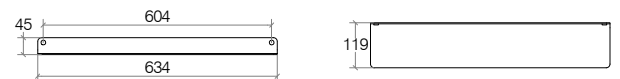

| 51818 | Bianco White Bkanc Weiß | Nero Black Noir Schwarz | Artic Artic Artic Artic | Sailor blue Sailor blue Sailor blue Sailor blue | Grigio Grey Gris Grau | Sabbia Sand Sable Sand | Tortora Tortora Tortora Tortora | Sage Sage Sage Sage | Ambra Ambra Ambra Ambra |
|-------|----------------------------------|----------------------------------|----------------------------------|--|--------------------------------|---------------------------------|--|------------------------------|----------------------------------|
| | .09 | .23 | .90 | .92 | .95 | .98 | .99 | .73 | .86 |
| € | 81,00 | 81,00 | 81,00 | 81,00 | 81,00 | 81,00 | 81,00 | 81,00 | 81,00 |

SAETA

Supporto con mensola 634 mm, foro sx

Towel holder and accessories bar 634 mm, left hole / Etagère avec p.serviettes - support pour accessoires 634 mm, trou à gauche / Halter mit Ablage 634 mm Loch Links

| | Bianco White Bkanc Weiß | Nero Black Noir Schwarz | Artic Artic Artic Artic | Sailor blue Sailor blue Sailor blue Sailor blue | Grigio Grey Gris Grau | Sabbia Sand Sable Sand | Tortora Tortora Tortora Tortora | Sage Sage Sage Sage | Ambra Ambra Ambra Ambra |
|--------------|----------------------------------|----------------------------------|----------------------------------|--|--------------------------------|---------------------------------|--|------------------------------|----------------------------------|
| 51819 | .09 | .23 | .90 | .92 | .95 | .98 | .99 | .73 | .86 |
| € | 84,00 | 84,00 | 84,00 | 84,00 | 84,00 | 84,00 | 84,00 | 84,00 | 84,00 |

Supporto con mensola 634 mm, foro dx

Towel holder and accessories bar 634 mm, right hole / Etagère avec p.serviettes - support pour accessoires 634 mm, trou à droite / Halter mit Ablage 634 mm Loch Rechts

| | Bianco White Bkanc Weiß | Nero Black Noir Schwarz | Artic Artic Artic Artic | Sailor blue Sailor blue Sailor blue Sailor blue | Grigio Grey Gris Grau | Sabbia Sand Sable Sand | Tortora Tortora Tortora Tortora | Sage Sage Sage Sage | Ambra Ambra Ambra Ambra |
|----------------|----------------------------------|----------------------------------|----------------------------------|--|--------------------------------|---------------------------------|--|------------------------------|----------------------------------|
| 51819DX | .09 | .23 | .90 | .92 | .95 | .98 | .99 | .73 | .86 |
| € | 84,00 | 84,00 | 84,00 | 84,00 | 84,00 | 84,00 | 84,00 | 84,00 | 84,00 |

Dosapone in melamina 250 ml

Melamine soap dispenser 250 ml / Distributeur savon liquide en mélamine 250 ml / Melamine Seifenspender 250 ml

| | Bianco White Bkanc Weiß | Nero Black Noir Schwarz | Acciaio inox Stainless steel Acier inoxydable Edelstahl | Artic Artic Artic Artic | Sailor blue Sailor blue Sailor blue Sailor blue | Grigio Grey Gris Grau | Sabbia Sand Sable Sand | Tortora Tortora Tortora Tortora | Sage Sage Sage Sage | Ambra Ambra Ambra Ambra |
|-------------|----------------------------------|----------------------------------|--|----------------------------------|--|--------------------------------|---------------------------------|--|------------------------------|----------------------------------|
| 5152 | .09 | .23 | .29 | .90 | .92 | .95 | .98 | .99 | .73 | .86 |
| € | 66,00 | 66,00 | 66,00 | 66,00 | 66,00 | 66,00 | 66,00 | 66,00 | 66,00 | 66,00 |

Portaspazzolini in melamina

Melamine toothbrush holder / Porte-brosses à dents en mélamine / Melamine Zahnpfutzbecher

| | Bianco White Bkanc Weiß | Nero Black Noir Schwarz | Acciaio inox Stainless steel Acier inoxydable Edelstahl | Artic Artic Artic Artic | Sailor blue Sailor blue Sailor blue Sailor blue | Grigio Grey Gris Grau | Sabbia Sand Sable Sand | Tortora Tortora Tortora Tortora | Sage Sage Sage Sage | Ambra Ambra Ambra Ambra |
|-------------|----------------------------------|----------------------------------|--|----------------------------------|--|--------------------------------|---------------------------------|--|------------------------------|----------------------------------|
| 5146 | .09 | .23 | .29 | .90 | .92 | .95 | .98 | .99 | .73 | .86 |
| € | 44,00 | 44,00 | 44,00 | 44,00 | 44,00 | 44,00 | 44,00 | 44,00 | 44,00 | 44,00 |

Portasapone in melamina

Melamine soap dish / Porte-savon en mélamine / Melamine Seifenschale

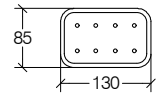
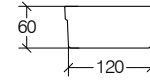

| | Bianco White Bkanc Weiß | Nero Black Noir Schwarz | Acciaio inox Stainless steel Acier inoxydable Edelstahl | Artic Artic Artic Artic | Sailor blue Sailor blue Sailor blue Sailor blue | Grigio Grey Gris Grau | Sabbia Sand Sable Sand | Tortora Tortora Tortora Tortora | Sage Sage Sage Sage | Ambra Ambra Ambra Ambra |
|-------------|---|---|---|---|---|---------------------------------------|--|---|-------------------------------------|---|
| 5147 | .09 | .23 | .29 | .90 | .92 | .95 | .98 | .99 | .73 | .86 |
| € | 44,00 | 44,00 | 44,00 | 44,00 | 44,00 | 44,00 | 44,00 | 44,00 | 44,00 | 44,00 |

SAETA

Scatola portaoggetti in melamina

Melamine box / Boîte porte-objets en mélamine / Melamine Schale

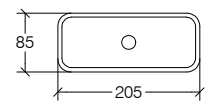
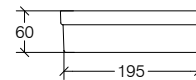

| | Bianco White Bkanc Weiß | Nero Black Noir Schwarz | Acciaio inox Stainless steel Acier inoxydable Edelstahl | Artic Artic Artic Artic | Sailor blue Sailor blue Sailor blue Sailor blue | Grigio Grey Gris Grau | Sabbia Sand Sable Sand | Tortora Tortora Tortora Tortora | Sage Sage Sage Sage | Ambra Ambra Ambra Ambra |
|-------------|---|---|---|---|---|---------------------------------------|--|---|-------------------------------------|---|
| 5148 | .09 | .23 | .29 | .90 | .92 | .95 | .98 | .99 | .73 | .86 |
| € | 48,00 | 48,00 | 48,00 | 48,00 | 48,00 | 48,00 | 48,00 | 48,00 | 48,00 | 48,00 |

Mensola d'appoggio in melamina

Melamine shelf 300 mm / Étagère en mélamine 300 mm / Melamine Konsole 300 mm

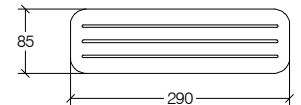
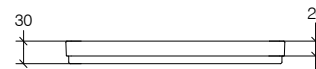

Metacrilato
Methacrylate
Méthacrylate
Methacrylat



| | |
|-------------|------------|
| 5153 | .09 |
| € | 38,00 |

Mensola doccia 300 mm

Shower shelf 300 mm / Tablette 300 mm / Ablage 300 mm



new

| | Bianco White Bkanc Weiß | Nero Black Noir Schwarz | Artic Artic Artic Artic | Sailor blue Sailor blue Sailor blue Sailor blue | Grigio Grey Gris Grau | Sabbia Sand Sable Sand | Tortora Tortora Tortora Tortora | Sage Sage Sage Sage | Ambra Ambra Ambra Ambra |
|--------------|---|---|---|---|---------------------------------------|--|---|-------------------------------------|---|
| 51820 | .09 | .23 | .90 | .92 | .95 | .98 | .99 | .73 | .86 |
| € | 67,00 | 67,00 | 67,00 | 67,00 | 67,00 | 67,00 | 67,00 | 67,00 | 67,00 |



SAETA

Mensola beauty (per phon, piastre, spazzole, spazio compatibile con cod.: 5146.. - 5152..)

Beauty shelf (for hairdryer, straighteners, brushes, 5146..-5152..) / Etagère beauté (pour sèche-cheveux, lisseurs, brosses, 5146..-5152..)

Beauty-Regal (für Haartrockner, Glätteisen, Bürsten 5146..-5152..)

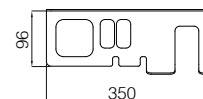
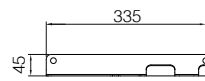

| new | Bianco | Nero | Artic | Sailor blue | Grigio | Sabbia | Tortora | Sage | Ambra |
|-------|------------------------|--------------------------|-------------------------|---|----------------------|-----------------------|-------------------------------|----------------------|-------------------------|
| | White Bkanc Weiß | Black Noir Schwarz | Artic Artic Artic | Sailor blue Sailor blue Sailor blue | Grey Gris Grau | Sand Sable Sand | Tortora Tortora Tortora | Sage Sage Sage | Ambra Ambra Ambra |
| 51822 | .09 | .23 | .90 | .92 | .95 | .98 | .99 | .73 | .86 |
| € | 80,00 | 80,00 | 80,00 | 80,00 | 80,00 | 80,00 | 80,00 | 80,00 | 80,00 |



Portascopino da pavimento e a parete

Floor and wall toilet brush holder / Porte-balai mural ou à poser / Wand oder Boden WC Bürstengarnitur

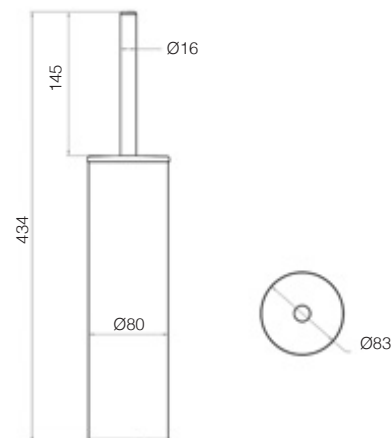

| | Bianco | Nero | Artic | Sailor blue | Grigio | Sabbia | Tortora | Sage | Ambra |
|-------|------------------------|--------------------------|-------------------------|---|----------------------|-----------------------|-------------------------------|----------------------|-------------------------|
| | White Bkanc Weiß | Black Noir Schwarz | Artic Artic Artic | Sailor blue Sailor blue Sailor blue | Grey Gris Grau | Sand Sable Sand | Tortora Tortora Tortora | Sage Sage Sage | Ambra Ambra Ambra |
| 50048 | .09 | .23 | .90 | .92 | .95 | .98 | .99 | .73 | .86 |
| € | 98,00 | 98,00 | 98,00 | 98,00 | 98,00 | 98,00 | 98,00 | 98,00 | 98,00 |





SKUARA

ACCESSORI _ Accessories _ Accessoires _ Accessoires



SKUARA: diritta - precisa.

Una serie diventata iconica del nostro brand. Ideando questa collezione siamo stati precursori di un trend poi diventato consuetudine per le nostre collezioni più identificative.

EN

SKUARA: straight, accurate.

A range that has become iconic for our brand. This collection turned us into the pioneers of a trend that later became the tradition for our most identifiable collections.

FR

SKUARA : droite, précise.

Une série devenue iconique pour notre marque. En concevant cette collection, nous avons été les précurseurs d'une tendance qui est devenue plus tard la référence de nos collections les plus identifiables.

DE

SKUARA: "gerade" "präzise".

Eine Serie, die zur Ikone unserer Marke geworden ist. Durch die Schaffung dieser Kollektion haben wir einen Trend vorweggenommen, der später für unsere prägendsten Kollektionen zur Gewohnheit geworden ist.

FINITURE _ Finishes _ Finitions _ Ausführung:

Ottone cromato con inserti in acciaio o porcellana

Chromed brass with ceramic or steel inserts

Laiton chromé avec accessoires en céramique ou en acier

Verchromtes Messing mit Einsätzen aus Keramik oder Stahl

Ottone cromato

Chromed brass

Laiton chromé

Verchromtes Messing



.29

Fissaggio con viti a muro _ Screwed to the wall _ Fixation au mur avec vis _ Wandbefestigung mit Schrauben



SKUARA

Portarotolo

Toilet paper holder / Porte-rouleau / Toilettenpapierhalter

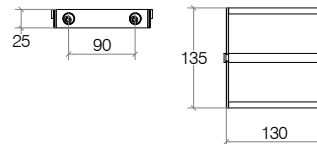

Ottone cromato
Chromed brass
Laiton chromé
Verchromtes Messing



| | |
|--------------|------------|
| 52806 | .29 |
| € | 87,00 |

Portarotolo doppio

Double toilet paper holder / Porte-rouleau double / Toilettenpapierhalter doppelt

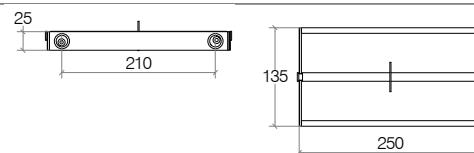
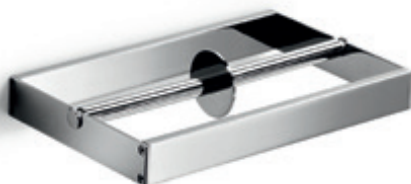

Ottone cromato
Chromed brass
Laiton chromé
Verchromtes Messing



| | |
|--------------|------------|
| 52807 | .29 |
| € | 101,00 |

Appendino doppio

Double hook / Patère double / Hacken doppelt

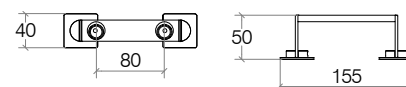

Ottone cromato
Chromed brass
Laiton chromé
Verchromtes Messing



| | |
|--------------|------------|
| 52853 | .29 |
| € | 71,00 |

Griglia con portasalviette 600 mm

Shelf with towel rail 600 mm / Rack porte-serviettes 600 mm avec barre / Ablage mit Handtuchhalter 600 mmschwenkbar

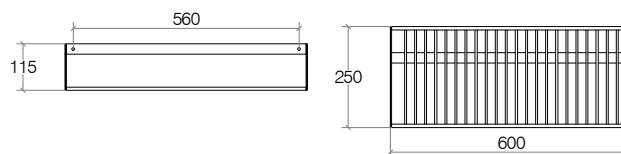

Ottone cromato
Chromed brass
Laiton chromé
Verchromtes Messing

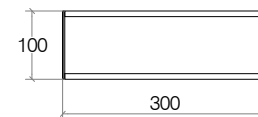
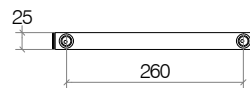

| | |
|--------------|------------|
| 52867 | .29 |
| € | 296,00 |

SKUARA**Portasalvietta / porta accessori 300 mm**Towel holder accessories bar 300 mm / Porte-serviettes support pour accessoires (à équiper) 300 mm
Handtuchhalter Halter für Accessoires 300 mm**Ottone cromato**
Chromed brass
Laiton chromé
Verchromtes Messing**52813****.29**

€

89,00

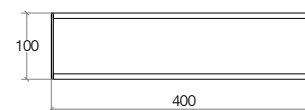
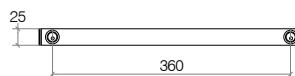
**Portasalvietta / porta accessori 400 mm**Towel holder accessories bar 400 mm / Porte-serviettes support pour accessoires (à équiper) 400 mm
Handtuchhalter Halter für Accessoires 400 mm**Ottone cromato**
Chromed brass
Laiton chromé
Verchromtes Messing**52814****.29**

€

99,00

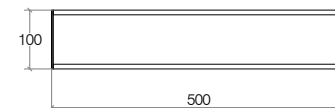
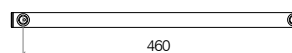
**Portasalvietta / porta accessori 500 mm**Towel holder accessories bar 500 mm / Porte-serviettes support pour accessoires (à équiper) 500 mm
Handtuchhalter Halter für Accessoires 500 mm**Ottone cromato**
Chromed brass
Laiton chromé
Verchromtes Messing**52815****.29**

€

120,00

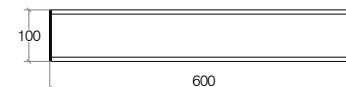
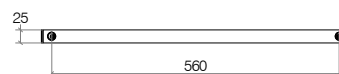
**Portasalvietta / porta accessori 600 mm**Towel holder accessories bar 600 mm / Porte-serviettes support pour accessoires (à équiper) 600 mm
Handtuchhalter Halter für Accessoires 600 mm**Ottone cromato**
Chromed brass
Laiton chromé
Verchromtes Messing**52816****.29**

€

129,00



SKUARA

Portasalviette / porta accessori 800 mm

Towel holder accessories bar 800 mm / Porte-serviettes support pour accessoires (à équiper) 800 mm
Handtuchhalter Halter für Accessoires 800 mm

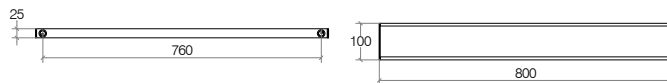

Ottone cromato
Chromed brass
Laiton chromé
Verchromtes Messing



| | |
|--------------|------------|
| 52818 | .29 |
| € | 153,00 |

Supporto 82 mm

Bracket 82 mm / Support 82 mm / Halter 82 mm

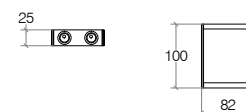

Ottone cromato
Chromed brass
Laiton chromé
Verchromtes Messing



| | |
|--------------|------------|
| 52808 | .29 |
| € | 60,00 |

Supporto 100 mm

Bracket 100 mm / Support 100 mm / Halter 100 mm

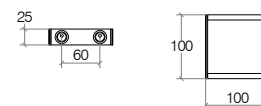

Ottone cromato
Chromed brass
Laiton chromé
Verchromtes Messing



| | |
|--------------|------------|
| 52810 | .29 |
| € | 64,00 |

Supporto 120 mm

Bracket 120 mm / Support 120 mm / Halter 120 mm

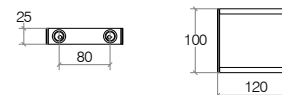

Ottone cromato
Chromed brass
Laiton chromé
Verchromtes Messing



| | |
|--------------|------------|
| 52811 | .29 |
| € | 67,00 |

SKUARA**Supporto 204 mm**

Bracket 204 mm / Support 204 mm / Halter 204 mm

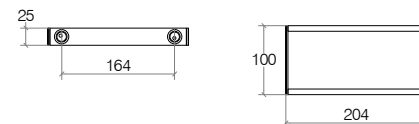

Ottone cromato
 Chromed brass
 Laiton chromé
 Verchromtes Messing
**52812****.29**

€

79,00

**Bicchiere, abbinabile con supporto minimo 80 mm**

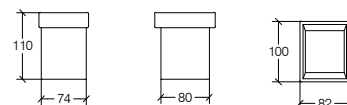
Tumbler, matching with bracket min size 80 mm / Verre, compatible avec support min 80 mm / Becher verwendbar mit Halter Min 80 mm



Ceramica
 Ceramic
 Céramique
 Keramik
**52801****.09**

€

32,00

**Bicchiere, abbinabile con supporto minimo 80 mm**

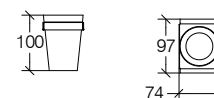
Tumbler, matching with bracket min size 80 mm / Verre, compatible avec support min 80 mm / Becher verwendbar mit Halter Min 80 mm



Acciaio inox lucido
 Polished stainless steel
 Acier inoxydable brillant
 Poliert Edelstahl
**52801****.29**

€

39,00

Vaschetta portasapone, abbinabile con supporto minimo 120 mm

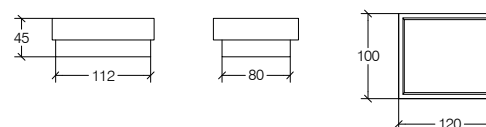
Soap dish, matching with bracket minimum size 120 mm / Porte-savon, compatible avec support minimum 120 mm / Seifenablage verwendbar mit Halter Minimum 120 mm

Ceramica
 Ceramic
 Céramique
 Keramik
**52802****.09**

€

26,00



SKUARA

Vaschetta portasapone, abbinabile con supporto minimo 120 mm

Soap dish, matching with bracket minimum size 120 mm / Porte-savon, compatible avec support minimum 120 mm
Seifenablage verwendbar mit Halter Minimum 120 mm

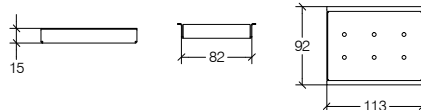

Acciaio inox lucido
Polished stainless steel
Acier inoxydable brillant
Poliert Edelstahl



| | |
|--------------|------------|
| 52802 | .29 |
| € | 26,00 |



Vaschetta portasapone, abbinabile con supporto minimo 200 mm

Soap dish, matching with bracket minimum size 200 mm / Porte-savon, compatible avec support minimum 200 mm
Seifenablage verwendbar mit Halter Minimum 200 mm

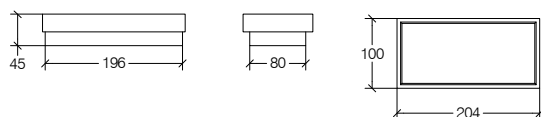

Ceramica
Ceramic
Céramique
Keramik



| | |
|--------------|------------|
| 52803 | .09 |
| € | 36,00 |



Vaschetta portasapone, abbinabile con supporto minimo 200 mm

Soap dish, matching with bracket minimum size 200 mm / Porte-savon, compatible avec support minimum 200 mm
Seifenablage verwendbar mit Halter Minimum 200 mm

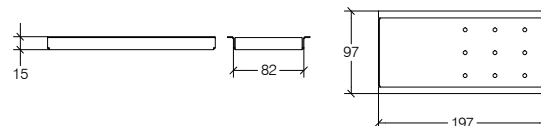

Acciaio inox lucido
Polished stainless steel
Acier inoxydable brillant
Poliert Edelstahl



| | |
|--------------|------------|
| 52803 | .29 |
| € | 36,00 |



Dosapone 300 ml, abbinabile con supporto minimo 80 mm

Soap dispenser 300 ml, matching with bracket size 80 mm / Distributeur savon liquide 300 ml, compatible avec support 80 mm
Seifenspender 300 ml, verwendbar mit Halter Min. 80 mm

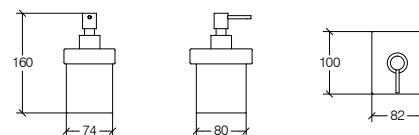

Ceramica
Ceramic
Céramique
Keramik



| | |
|-----------------|------------|
| 52804.09 | .29 |
| € | 60,00 |



SKUARA

Dosasapone 350 ml, abbinabile con supporto minimo 80 mm

Soap dispenser 350 ml, matching with bracket size 80 mm / Distributeur savon liquide 350 ml, compatible avec support 80 mm
eifenspender 350 ml, verwendbar mit Halter Min. 80 mm

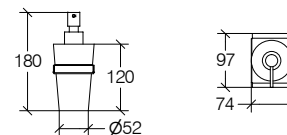

Acciaio inox lucido
Polished stainless steel
Acier inoxydable brillant
Poliert Edelstahl



| | |
|--------------|------------|
| 52804 | .29 |
| € | 71,00 |

Portascopino, abbinabile con supporto minimo 100 mm

Toilet brush, matching with bracket minimum size 100 mm / Porte-balai, compatible avec support minimum 100 mm
Toilettenbürstengarnitur verwendbar mit Halter Minimum 100 mm

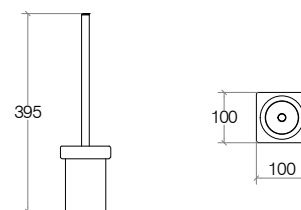

Ottone cromato
Chromed brass
Laiton chromé
Verchromtes Messing



| | |
|-----------------|------------|
| 52805.09 | .29 |
| € | 67,00 |

Portascopino, abbinabile con supporto minimo 100 mm

Toilet brush, matching with bracket minimum size 100 mm / Porte-balai, compatible avec support minimum 100 mm
Toilettenbürstengarnitur verwendbar mit Halter Minimum 100 mm

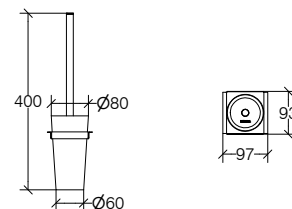

Ottone cromato
Chromed brass
Laiton chromé
Verchromtes Messing



| | |
|--------------|------------|
| 52805 | .29 |
| € | 84,00 |

SKUARA

Portascopino da pavimento e a parete

Floor and wall toilet brush holder / Porte-balai mural ou à poser / Wand oder Boden WC Bürstengarnitur

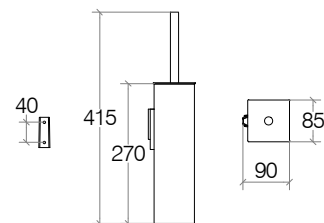

Acciaio inox lucido
Polished stainless steel
Acier inox brillant
Glänzer Edelstahl



50056

.29

€

140,00



Mensola vetro satinato 400 mm

Satinated glass shelf 400 mm / Tablette en verre satiné 400 mm / Glasablage 400 mm

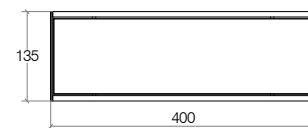
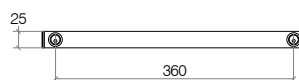

Ottone cromato
Chromed brass
Laiton chromé
Verchromtes Messing



52834

.29

€

146,00



SKUARA

Mensola vetro satinato 600 mm

Satinated glass shelf 600 mm / Tablette en verre satiné 600 mm / Glasablage 600 mm

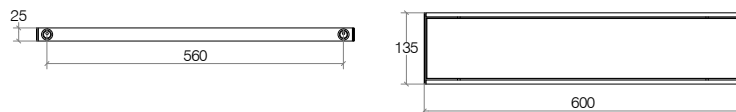

Ottone cromato
Chromed brass
Laiton chromé
Verchromtes Messing



| | |
|--------------|---------------|
| 52836 | .29 |
| € | 164,00 |



Griglia 300 mm

Shelf grid 300 mm / Tablette 300 mm / Ablage 300 mm



Ottone cromato
Chromed brass
Laiton chromé
Verchromtes Messing



| | |
|--------------|---------------|
| 52843 | .29 |
| € | 121,00 |



Griglia 400 mm

Shelf grid 400 mm / Tablette 400 mm / Ablage 400 mm

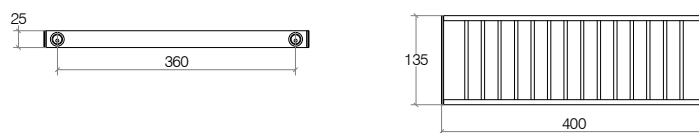

Ottone cromato
Chromed brass
Laiton chromé
Verchromtes Messing



| | |
|--------------|---------------|
| 52844 | .29 |
| € | 146,00 |



SKUARA

BAKETO

ACCESSORI _ Accessories _ Accessoires _ Accessoires



BAKETO: bastoncino - ramoscello.

La collezione più iconica, semplice e senza tempo di Lineabeta. La scaletta porta salviette è l'elemento più distintivo e curioso della collezione.

EN

BAKETO: stick, twig.

The simplest, most iconic and timeless collection by Lineabeta. The towel holder ladder is the most distinctive and peculiar element of the collection.

FR

BAKETO : petit bâton, brindille.

La collection la plus emblématique, simple et intemporelle de Lineabeta. L'échelle porte-serviettes est l'éléments plus distinctifs et originaux de la collection.

DE

BAKETO: Stäbchen, Zweig.

Die ikonischste, schlichte und zeitlose Kollektion von Lineabeta. Vertikalstangen und die Handtuchleiter sind die hervorstechenden und interessantesten Elemente der Kollektion.

FINITURE _ Finishes _ Finitions _ Ausführung:

Ottone cromato o verniciato nero opaco con inserti in vetro o porcellana

Chromed or matt black painted brass with glass or porcelain inserts

Laiton chromé ou verni noir mat avec accessoires en verre ou en porcelaine

Verchromtes oder mattschwarz lackiertes Messing mit Einsätzen aus Glas oder Porzellan

Ottone cromato

Chromed brass
Laiton chromé
Verchromtes Messing



.29

Ottone verniciato nero opaco

Matt black painted brass
Laiton laqué noir mat
Lackiertem Messing Schwarz Matt



.23

Fissaggio con viti a muro _ Screwed to the wall _ Fixation au mur avec vis _ Wandbefestigung mit Schrauben



BAKETO

Portarotolo coperto

Toilet paper holder with lid / Porte-rouleau avec couverture / Toilettenpapierhalter mit Deckel

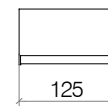
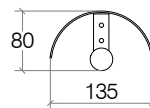

Ottone cromato
Chromed brass
Laiton chromé
Verchromtes Messing

Ottone verniciato
Painted brass
Laiton laqué
Lackiertem Messing



| | | |
|-------------|------------|------------|
| 5203 | .29 | .23 |
| € | 55,00 | 58,00 |

Portarotolo

Toilet paper holder / Porte-rouleau / Toilettenpapierhalter

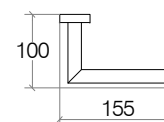

Ottone cromato
Chromed brass
Laiton chromé
Verchromtes Messing

Ottone verniciato
Painted brass
Laiton laqué
Lackiertem Messing



| | | |
|-------------|------------|------------|
| 5204 | .29 | .23 |
| € | 44,00 | 47,00 |

Portarotolo doppio

Double toilet paper holder / Porte-rouleau double / Toilettenpapierhalter doppelt

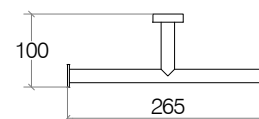

Ottone cromato
Chromed brass
Laiton chromé
Verchromtes Messing

Ottone verniciato
Painted brass
Laiton laqué
Lackiertem Messing



| | | |
|-------------|------------|------------|
| 5205 | .29 | .23 |
| € | 53,00 | 56,00 |

Portarotolo basculante con coperchio

Tilting toilet paper holder with lid / Porte-rouleau basculant avec couverture / Kippbarer Toilettenpapierhalter mit Deckel

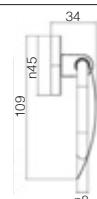
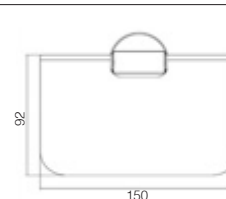

Ottone cromato
Chromed brass
Laiton chromé
Verchromtes Messing

Ottone verniciato
Painted brass
Laiton laqué
Lackiertem Messing



| | | |
|-------------|------------|------------|
| new | | |
| 5207 | .29 | .23 |
| € | 70,00 | 95,00 |

BAKETO

Coppia appendini

2 Hooks / Jeu de 2 patères / Paar Hacken



Ottone cromato
Chromed brass
Laiton chromé
Verchromtes Messing

Ottone verniciato
Painted brass
Laiton laqué
Lackiertem Messing



| | | |
|-------------|------------|------------|
| 5208 | .29 | .23 |
| € | 46,00 | 49,00 |

Griglia portasalviette

Towel shelf / Rack porte-serviettes / Handtuchablage

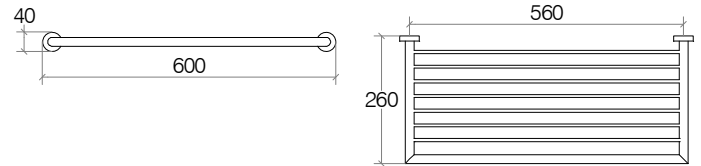

Ottone cromato
Chromed brass
Laiton chromé
Verchromtes Messing

Ottone verniciato
Painted brass
Laiton laqué
Lackiertem Messing



| | | |
|-------------|------------|------------|
| 5216 | .29 | .23 |
| € | 156,00 | 164,00 |

Portasalviette 300 mm

Towel rail 300 mm / Porte-serviettes 300 mm / Handtuchhalter 300 mm

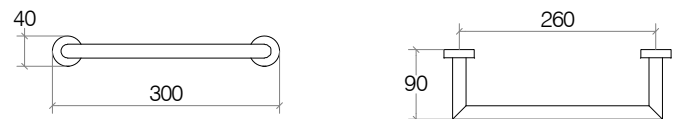

Ottone cromato
Chromed brass
Laiton chromé
Verchromtes Messing

Ottone verniciato
Painted brass
Laiton laqué
Lackiertem Messing



| | | |
|--------------|------------|------------|
| 52091 | .29 | .23 |
| € | 66,00 | 70,00 |

Portasalviette 400 mm

Towel rail 400 mm / Porte-serviettes 400 mm / Handtuchhalter 400 mm



Ottone cromato
Chromed brass
Laiton chromé
Verchromtes Messing

Ottone verniciato
Painted brass
Laiton laqué
Lackiertem Messing



| | | |
|-------------|------------|------------|
| 5210 | .29 | .23 |
| € | 73,00 | 77,00 |

BAKETO

BAKETO

Portasalviette 500 mm

Towel rail 500 mm / Porte-serviettes 500 mm / Handtuchhalter 500 mm

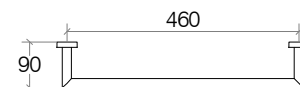
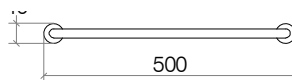

Ottone cromato
Chromed brass
Laiton chromé
Verchromtes Messing

Ottone verniciato
Painted brass
Laiton laqué
Lackiertem Messing



| | | |
|-------------|------------|------------|
| 5211 | .29 | .23 |
| € | 80,00 | 84,00 |

Portasalviette 600 mm

Towel rail 600 mm / Porte-serviettes 600 mm / Handtuchhalter 600 mm

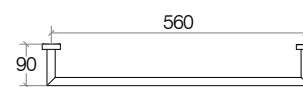
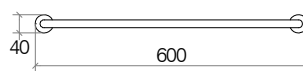

Ottone cromato
Chromed brass
Laiton chromé
Verchromtes Messing

Ottone verniciato
Painted brass
Laiton laqué
Lackiertem Messing



| | | |
|-------------|------------|------------|
| 5212 | .29 | .23 |
| € | 86,00 | 91,00 |

Portasalviette doppio 600 mm

Double towel rail 600 mm / Porte-serviettes double 600 mm / Doppelhandtuchhalter 600 mm

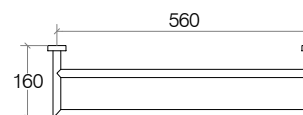
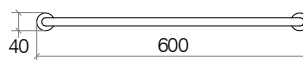

Ottone cromato
Chromed brass
Laiton chromé
Verchromtes Messing

Ottone verniciato
Painted brass
Laiton laqué
Lackiertem Messing



| | | |
|-------------|------------|------------|
| 5214 | .29 | .23 |
| € | 103,00 | 109,00 |

Portasalviette doppio snodato

Double jointed towel rail / Porte-serviettes articulé double / Doppelhandtuchhalter schwenkbar

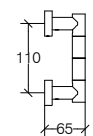
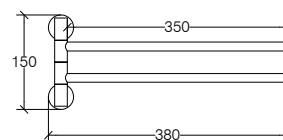

Ottone cromato
Chromed brass
Laiton chromé
Verchromtes Messing

Ottone verniciato
Painted brass
Laiton laqué
Lackiertem Messing



| | | |
|--------------|------------|------------|
| 52152 | .29 | .23 |
| € | 113,00 | 119,00 |

BAKETO

Anello portasalviette

Towel ring / Anneau porte-serviettes / Handtuchring

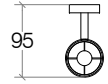
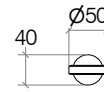

Ottone cromato
Chromed brass
Laiton chromé
Verchromtes Messing

Ottone verniciato
Painted brass
Laiton laqué
Lackiertem Messing



52153

.29

.23

€

36,00

38,00



Scaletta portasalviette a muro

Wall towel holder / Echelle porte-serviettes mural / Handtuchständer mit Anlehnung am Wand

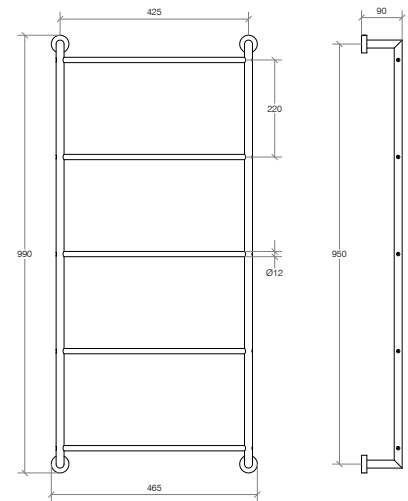
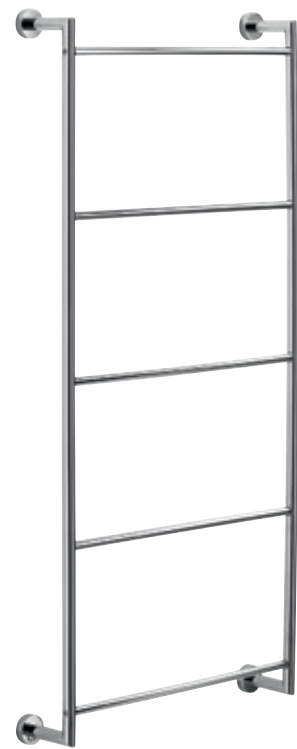

Ottone cromato
Chromed brass
Laiton chromé
Verchromtes Messing

Ottone verniciato
Painted brass
Laiton laqué
Lackiertem Messing



5233

.29

.23

€

260,00

273,00



Supporto singolo

Single holder / Support individuel / Halter lose

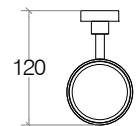
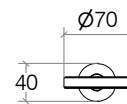

Ottone cromato
Chromed brass
Laiton chromé
Verchromtes Messing

Ottone verniciato
Painted brass
Laiton laqué
Lackiertem Messing



52011

.29

.23

€

32,00

34,00



BAKETO

BAKETO

Bicchieri

Tumbler / Verre / Becher

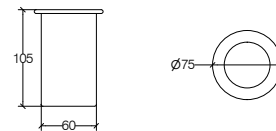

Porcellana
Porcelaine
Porcelaine
Porzellan



Vetro acidato
Etched glass
Verre dépoli
Geätztes Glas



| | | |
|--------------|------------|------------|
| 55003 | .09 | .81 |
| € | 20,00 | 20,00 |

Portasapone

Soap dish / Porte-savon / Seifenschale

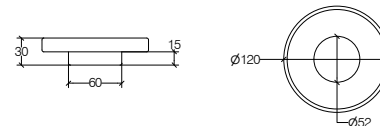

Porcellana
Porcelaine
Porcelaine
Porzellan



Vetro acidato
Etched glass
Verre dépoli
Geätztes Glas



| | | |
|--------------|------------|------------|
| 55004 | .09 | .81 |
| € | 20,00 | 20,00 |

Dosasapone 200 ml

Soap dispenser 200 ml / Distributeur savon liquide 200 ml / Seifenspender 200 ml

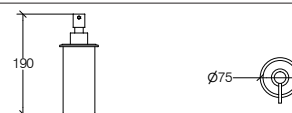

Ottone cromato
Chromed brass
Laiton chromé
Verchromtes Messing



Porcellana
Porcelaine
Porcelaine
Porzellan



.09

50,00

Ottone verniciato
Painted brass
Laiton laqué
Lackiertem Messing



.09.23

50,00

Ottone cromato
Chromed brass
Laiton chromé
Verchromtes Messing



.81

50,00

Ottone verniciato
Painted brass
Laiton laqué
Lackiertem Messing



.81.23

50,00

| | | | | |
|--------------|------------|---------------|------------|---------------|
| 55006 | .09 | .09.23 | .81 | .81.23 |
| € | 50,00 | 50,00 | 50,00 | 50,00 |

Griglietta in silicone antiscivolo per Art. 55004 (20 pezzi assortiti in 4 colori)

20 grip grids for soap dish 55004 / Grille en silicón 20 picks pour porte savon 55004 / 20 Einlagen für Seifenschale 55004

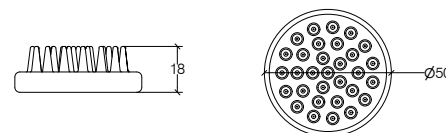

Silicone
Silicon
Silicone
Silikon



.09



.15



.16



.17

| | | | | |
|-------------|------------|------------|------------|------------|
| 5200 | .09 | .15 | .16 | .17 |
| € | | 48,00 | | |

BAKETO

Dosapone a parete 180 ml

Wall soap dispenser 180 ml / Distributeur savon liquide mural 180 ml / Wandseifenspender 180 ml

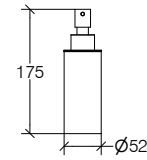

Ottone cromato
Chromed brass
Laiton chromé
Verchromtes Messing

Ottone verniciato
Painted brass
Laiton laqué
Lackiertem Messing



| | | |
|-------------|------------|------------|
| 5217 | .29 | .23 |
| € | 70,00 | 74,00 |

Piantana portarotolo e portascopino

Toilet paper and brush holder stand / Porte-rouleau sur pied avec porte-balais / Kombi-Bürstengarnitur

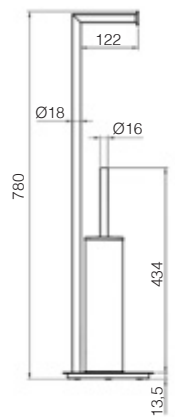
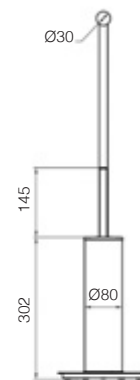

Acciaio inox
Stainless steel
Acier inoxydable
Edelstahl

Acciaio inox verniciato nero
Black painted stainless steel
Acier inoxydable laqué noir
Lackiertem Edelstahl Schwarz



| | | |
|-------------|------------|------------|
| new | .29 | .23 |
| 5121 | .29 | .23 |
| € | 350,00 | 294,00 |

BAKETO

Supporto portascopino

Toilet brush holder / Support porte-balai / Halter lose für Toilettenbürsten

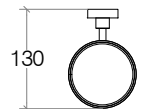
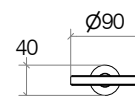

Ottone cromato
Chromed brass
Laiton chromé
Verchromtes Messing

Ottone verniciato
Painted brass
Laiton laqué
Lackiertem Messing



| | | |
|--------------|------------|------------|
| 52061 | .29 | .23 |
| € | 33,00 | 35,00 |

BAKETO

Portascopino

Toilet brush / Porte-balai / Toilettenbürstengarnitur

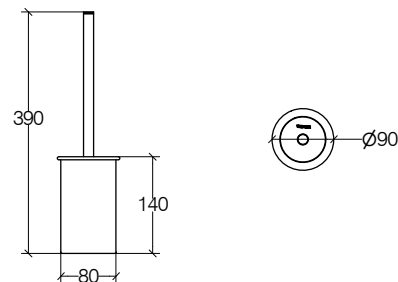

| | | | | |
|--------------|--|---|--|---|
| | Ottone cromato Chromed brass Laiton chromé Verchromtes Messing | Ottone verniciato Painted brass Laiton laqué Lackiertem Messing | Ottone cromato Chromed brass Laiton chromé Verchromtes Messing | Ottone verniciato Painted brass Laiton laqué Lackiertem Messing |
| | Vetro acidato Etched glass Verre dépoli Geätztes Glas | | Porcellana Porcelaine Porcelaine Porzellan | |
| 55062 | .81 | .81.23 | .09 | .09.23 |
| € | 51,00 | 51,00 | 51,00 | 51,00 |

Portascopino da pavimento e a parete

Floor and wall toilet brush holder / Porte-balai mural ou à poser / Wand oder Boden WC Bürstengarnitur

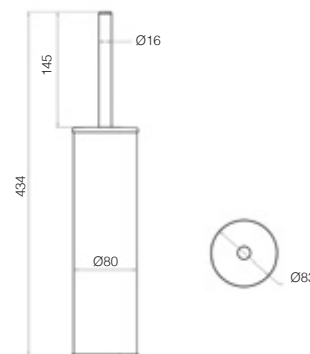

| | | |
|--------------|---|--|
| | Acciaio inox lucido Polished stainless steel Acier inox brillant Glänzter Edelstahl | Acciaio verniciato Painted stainless steel Acier inox laqué Lackiertem Edelstahl |
| 50048 | .29 | .23 |
| € | 109,00 | 98,00 |



Coppia supporti mensola

Shelf wall bearing (1 pair) / Paire de supports pour tablette / Paar Halter für Ablage

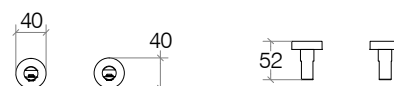

Ottone cromato
Chromed brass
Laiton chromé
Verchromtes Messing

Ottone verniciato
Painted brass
Laiton laqué
Lackiertem Messing



| | | |
|-------------|------------|------------|
| 5234 | .29 | .23 |
| € | 44,00 | 47,00 |



BAKETO

Mensola vetro temperato 392 mm

Glass shelf 392 mm / Etagère en verre 392 mm / Glasablage 392 mm

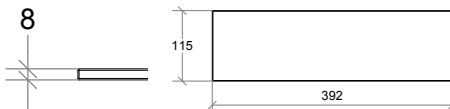

Vetro acidato
Etched glass
Verre dépoli
Geätztes Glas

| | |
|-------------|------------|
| 5276 | .81 |
| € | 38,00 |

Mensola vetro temperato 492 mm

Glass shelf 492 mm / Etagère en verre 492 mm / Glasablage 492 mm

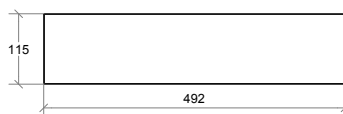

Vetro acidato
Etched glass
Verre dépoli
Geätztes Glas

| | |
|-------------|------------|
| 5277 | .81 |
| € | 41,00 |

Mensola vetro temperato 592 mm

Glass shelf 592 mm / Etagère en verre 592 mm / Glasablage 592 mm

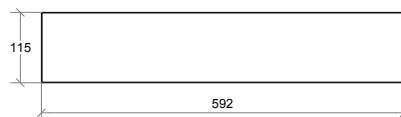

Vetro acidato
Etched glass
Verre dépoli
Geätztes Glas

| | |
|-------------|------------|
| 5278 | .81 |
| € | 46,00 |

Mensola vetro temperato 792 mm

Glass shelf 792 mm / Etagère en verre 792 mm / Glasablage 792 mm

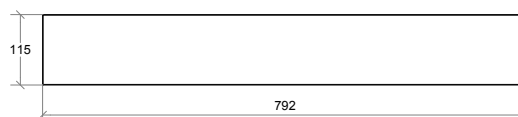

Vetro acidato
Etched glass
Verre dépoli
Geätztes Glas

| | |
|-------------|------------|
| 5279 | .81 |
| € | 54,00 |

TA-BAKETOFIX

5210
Portasalviette 400 mm

Towel rail 400 mm / Porte-serviettes 400 mm / Handtuchhalter 400 mm

5204
Portarotolo

Toilet paper holder / Porte-rouleau / Toilettenpapierhalter

5208
Coppia appendini

2 Hooks / Jeu de 2 patères / Paar Hacken

50048
Portascopino

Toilet brush / Porte-balai / Toilettenbürstengarnitur

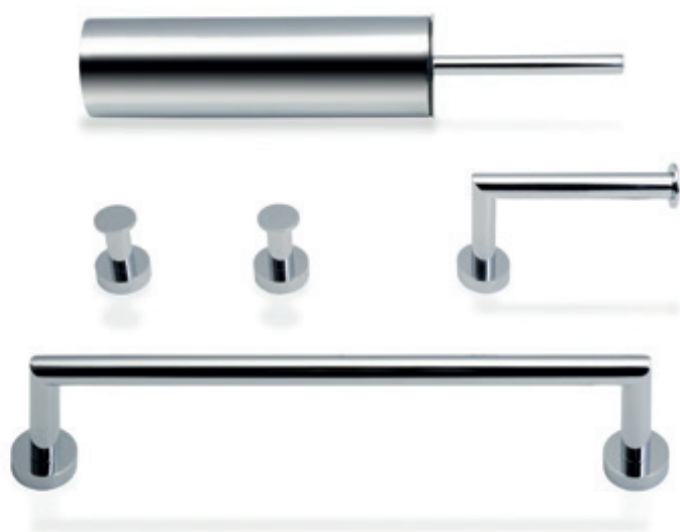

Cromato
Chromed
Chromé
Verchromtes

Verniciato nero
Black painted
Noir laqué
Lackiertem Schwarz

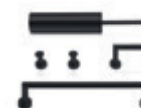

| | | |
|---------------------|------------|------------|
| TA-BAKETOFIX | .29 | .23 |
| € | 256,00 | 269,00 |



NAPIE

ACCESSORI _ Accessories _ Accessoires _ Accessoires



NAPIE:

chi ha una grande napia è dotato di un grande naso.

La serie è solida, massiccia e trasmette una sensazione di durata nel tempo. L'oggetto del desiderio di questa collezione, peraltro adattabile anche ad altri ambienti, è la griglia portasalviette dotata di piccoli ganci ad S, da utilizzare per appendere spazzole e guanti per il corpo, Make up Pods, fascie per capelli o altro.

EN

Napie:

those who have a big "napia" have a big nose.

This range is solid, sturdy and conveys a feeling of durability. The object of desire of this collection, which can also be adapted to other environments, is the towel rail with small S-shaped hooks, to be used to hang body brushes and gloves, make-up pods, hair bands or other items.

FR

Napie :

qui a un gros 'napia', a un gros nez.

La série est solide, massive et donne une impression de durabilité. L'objet de désir de cette collection, qui peut également être adapté à d'autres contextes, est le porte-serviettes avec ses petits crochets en forme de S - à utiliser pour accrocher des brosses à cheveux, des gants de toilette, le nécessaire à démaquillage et à coiffer.

DE

Napie:

wer eine große "napia" hat, ist mit einer großen Nase gesegnet.

Die Serie ist solide, massiv und vermittelt das Gefühl, die Zeit zu überdauern. Bei dieser Kollektion ist das Objekt der Begierde, die sich im Übrigen auch an andere Umgebungen anpassen lässt, das Handtuchgitter mit kleinen s-förmigen Haken, die verwendet werden, um Bürsten und Körperhandschuhe, Make-up-Pads, Haarbänder oder Anderes aufzuhängen.

FINITURE _ Finishes _ Finitions _ Ausführung:

Acciaio inox lucido o spazzolato AISI 304 con inserti in vetro o porcellana o acciaio inox

Polished or brushed stainless steel AISI 304 with glass or porcelain inserts or stainless steel

Acier AISI 304 inoxydable poli ou brossé avec accessoires en verre ou en porcelaine ou acier inox

Polierter AISI 304 oder Gebürstet Edelstahl mit Einsätzen aus Glas oder Porzellan aus Edelstahl

Acciaio inox lucido

Polished stainless steel
Acier Inoxydable brillant
Edelstahl Glänzend



.29

Acciaio inox spazzolato

Brushed stainless steel
Acier inoxydable brossé
Edelstahl Gebürstet



.32

Fissaggio con viti a muro _ Screwed to the wall _ Fixation au mur avec vis _ Wandbefestigung mit Schrauben



NAPIE

Portarotolo

Toilet paper holder / Porte-rouleau / Toilettenpapierhalter

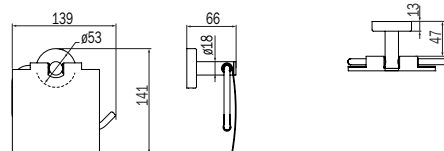

Acciaio inox lucido
Polished stainless steel
Acier Inoxydable brillant
Edelstahl Glänzend

Acciaio inox spazzolato
Brushed stainless steel
Acier inoxydable brossé
Edelstahl Gebürstet



| | | |
|--------------|------------|------------|
| 53138 | .29 | .32 |
| € | 65,00 | 70,00 |

Portarotolo

Toilet paper holder / Porte-rouleau / Toilettenpapierhalter

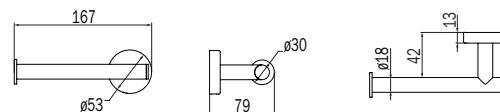

Acciaio inox lucido
Polished stainless steel
Acier Inoxydable brillant
Edelstahl Glänzend

Acciaio inox spazzolato
Brushed stainless steel
Acier inoxydable brossé
Edelstahl Gebürstet



| | | |
|---------------|------------|------------|
| 53139S | .29 | .32 |
| € | 46,00 | 52,00 |

Portarotolo

Toilet paper holder / Porte-rouleau / Toilettenpapierhalter

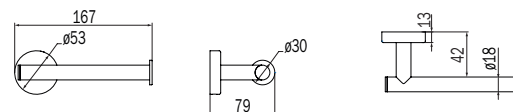

Acciaio inox lucido
Polished stainless steel
Acier Inoxydable brillant
Edelstahl Glänzend

Acciaio inox spazzolato
Brushed stainless steel
Acier inoxydable brossé
Edelstahl Gebürstet



| | | |
|---------------|------------|------------|
| 53139D | .29 | .32 |
| € | 46,00 | 52,00 |

Portarotolo con riserva

Toilet paper holder with reserve / Porte-rouleau réserve / Toilettenpapier Ersatzrollenhalter

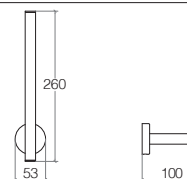

Acciaio inox lucido
Polished stainless steel
Acier Inoxydable brillant
Edelstahl Glänzend

Acciaio inox spazzolato
Brushed stainless steel
Acier inoxydable brossé
Edelstahl Gebürstet



| | | |
|--------------|------------|------------|
| 53140 | .29 | .32 |
| € | 52,00 | 57,00 |

NAPIE

Appendino
Hook / Patère / Hacken

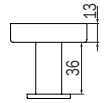
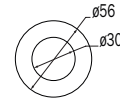

Acciaio Inox lucido
Polished stainless steel
Acier Inoxydable brillant
Edelstahl Glänzend

Acciaio inox spazzolato
Brushed stainless steel
Acier inoxydable brossé
Edelstahl Gebürstet



53136

.29

.32

€

26,00

28,00



Appendino doppio
Double hook / Patère double / Hacken doppelt

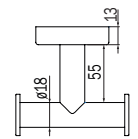
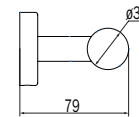
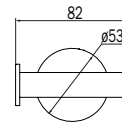

Acciaio Inox lucido
Polished stainless steel
Acier Inoxydable brillant
Edelstahl Glänzend

Acciaio inox spazzolato
Brushed stainless steel
Acier inoxydable brossé
Edelstahl Gebürstet



53137

.29

.32

€

32,00

34,00



Griglia con Portasalviette
Shelf with towel rail / Rack porte-serviettes / Handtuchhalter mit ablage

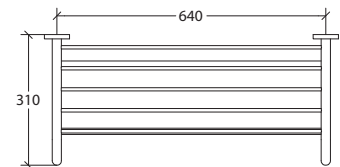
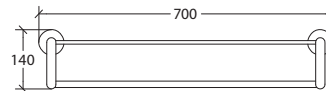

Acciaio Inox lucido
Polished stainless steel
Acier Inoxydable brillant
Edelstahl Glänzend

Acciaio inox spazzolato
Brushed stainless steel
Acier inoxydable brossé
Edelstahl Gebürstet



53135

.29

.32

€

200,00

217,00



Portasalviette 350 mm
Towel rail 350 mm / Porte-serviettes 350 mm / Handtuchhalter 350 mm

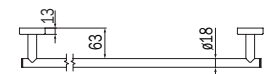
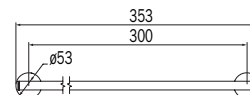

Acciaio Inox lucido
Polished stainless steel
Acier Inoxydable brillant
Edelstahl Glänzend

Acciaio inox spazzolato
Brushed stainless steel
Acier inoxydable brossé
Edelstahl Gebürstet



53120

.29

.32

€

72,00

77,00



NAPIE

NAPIE

Portasalviette 500 mm

Towel rail 500 mm / Porte-serviettes 500 mm / Handtuchhalter 500 mm

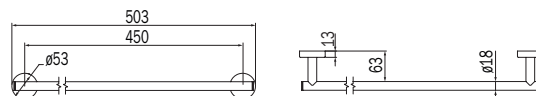

Acciaio inox lucido
Polished stainless steel
Acier Inoxydable brillant
Edelstahl Glänzend

Acciaio inox spazzolato
Brushed stainless steel
Acier inoxydable brossé
Edelstahl Gebürstet



| | | |
|--------------|------------|------------|
| 53121 | .29 | .32 |
| € | 77,00 | 83,00 |

Portasalviette 650 mm

Towel rail 650 mm / Porte-serviettes 650 mm / Handtuchhalter 650 mm

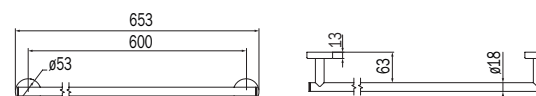

Acciaio inox lucido
Polished stainless steel
Acier Inoxydable brillant
Edelstahl Glänzend

Acciaio inox spazzolato
Brushed stainless steel
Acier inoxydable brossé
Edelstahl Gebürstet



| | | |
|--------------|------------|------------|
| 53122 | .29 | .32 |
| € | 83,00 | 88,00 |

Portasalviette 850 mm

Towel rail 850 mm / Porte-serviettes 850 mm / Handtuchhalter 850 mm

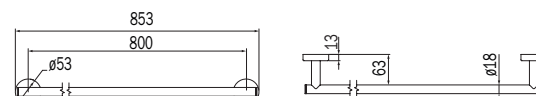

Acciaio inox lucido
Polished stainless steel
Acier Inoxydable brillant
Edelstahl Glänzend

Acciaio inox spazzolato
Brushed stainless steel
Acier inoxydable brossé
Edelstahl Gebürstet



| | | |
|--------------|------------|------------|
| 53123 | .29 | .32 |
| € | 89,00 | 95,00 |

Portasalviette doppio 500 mm

Double towel rail 500 mm / Porte-serviettes double 500 mm / Handtuchhalter doppelt 500 mm

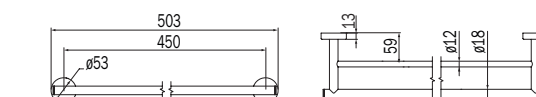

Acciaio inox lucido
Polished stainless steel
Acier Inoxydable brillant
Edelstahl Glänzend

Acciaio inox spazzolato
Brushed stainless steel
Acier inoxydable brossé
Edelstahl Gebürstet



| | | |
|--------------|------------|------------|
| 53130 | .29 | .32 |
| € | 95,00 | 100,00 |

NAPIE

Portasalviette doppio 650 mm

Double towel rail 650 mm / Porte-serviettes double 650 mm / Handtuchhalter doppelt 650 mm

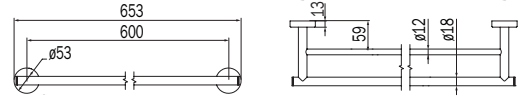

Acciaio inox lucido
Polished stainless steel
Acier inoxydable brillant
Edelstahl Glänzend

Acciaio inox spazzolato
Brushed stainless steel
Acier inoxydable brossé
Edelstahl Gebürstet



53131

.29

.32

€

100,00

106,00



Portasalviette

Towel rail / Porte-serviettes / Handtuchhalter

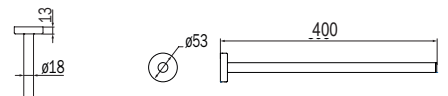

Acciaio inox lucido
Polished stainless steel
Acier inoxydable brillant
Edelstahl Glänzend

Acciaio inox spazzolato
Brushed stainless steel
Acier inoxydable brossé
Edelstahl Gebürstet



53133

.29

.32

€

48,00

54,00



Anello portasalviette

Towel ring / Anneau porte-serviettes / Handtuchring

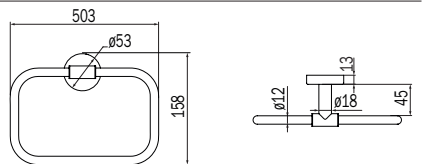

Acciaio inox lucido
Polished stainless steel
Acier inoxydable brillant
Edelstahl Glänzend

Acciaio inox spazzolato
Brushed stainless steel
Acier inoxydable brossé
Edelstahl Gebürstet



53134

.29

.32

€

50,00

56,00



Ghiera per accessori da appoggio

Tabletop ring accessories / Anneau d'appui pour accessoires / Ring für Accessories

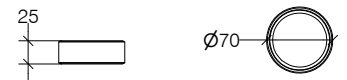

Acciaio inox lucido
Polished stainless steel
Acier inoxydable brillant
Edelstahl Glänzend



44070

.29

€

16,00

NAPIE

NAPIE

Supporto singolo

Single holder / Support individuel / Halter lose

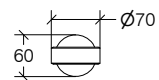

Acciaio inox lucido
Polished stainless steel
Acier inoxydable brillant
Edelstahl Glänzend

Acciaio inox spazzolato
Brushed stainless steel
Acier inoxydable brossé
Edelstahl Gebürstet



53145

.29

.32

€

37,00

43,00



Bicchieri

Tumbler / Verre / Becher

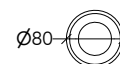
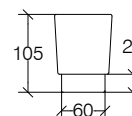

Porcellana
Porcelaine
Porcelaine
Porzellan

Acciaio inox lucido
Polished stainless steel
Acier inoxydable brillant
Edelstahl Glänzend

Vetro acidato
Etched glass
Verre dépoli
Geätztes Glas



53020

.09

.29

.81

€

26,00

48,00

19,00

Portasapone

Soap dish / Porte-savon / Seifenschale

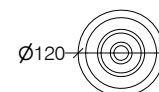
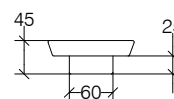

Porcellana
Porcelaine
Porcelaine
Porzellan

Acciaio inox lucido
Polished stainless steel
Acier inoxydable brillant
Edelstahl Glänzend

Vetro acidato
Etched glass
Verre dépoli
Geätztes Glas



53021

.09

.29

.81

€

28,00

48,00

23,00

Dosapone 300 ml

Soap dispenser 300 ml / Distributeur savon liquide 300 ml / Seifenspender 300 ml

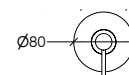
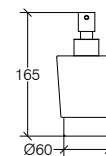

Porcellana
Porcelaine
Porcelaine
Porzellan

Acciaio lucido
Polished stainless steel
Acier inoxydable brillant
Glänzender Edelstahl

Vetro acidato
Etched glass
Verre dépoli
Geätztes Glas



53022

.09

.29

.81

€

57,00

61,00

52,00

NAPIE

Supporto portascopino

Toilet brush holder / Support porte-balai / Toilettenbürsten halter

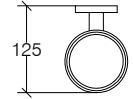
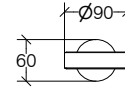

Acciaio inox lucido
Polished stainless steel
Acier inoxydable brillant
Edelstahl Glänzend

Acciaio inox spazzolato
Brushed stainless steel
Acier inoxydable brossé
Edelstahl Gebürstet



| | | |
|--------------|------------|------------|
| 53146 | .29 | .32 |
| € | 40,00 | 46,00 |



Portascopino

Toilet brush / Porte-balai / Toilettenbürstengarnitur

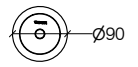
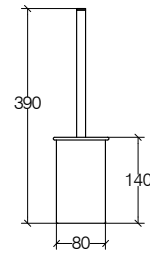

Vetro acidato
Etched glass
Verre dépoli
Geätztes Glas

Vetro acidato
Etched glass
Verre dépoli
Geätztes Glas

Porcellana
Porcelaine
Porcelaine
Porzellan

Porcellana
Porcelaine
Porcelaine
Porzellan



| | | | | |
|--------------|------------|---------------|------------|---------------|
| 55062 | .81 | .81.23 | .09 | .09.23 |
| € | 51,00 | 51,00 | 51,00 | 51,00 |

Portascopino da pavimento e a parete

Floor and wall toilet brush holder / Porte-balai mural ou à poser / Wand oder Boden WC Bürstengarnitur

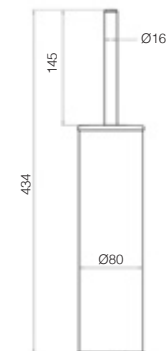

Acciaio inox lucido
Polished stainless steel
Acier inox brillant
Glänzender Edelstahl

Acciaio inox satinato
Satinated stainless steel
Acier inox satiné
Vereist Edelstahl



| | | |
|--------------|------------|------------|
| 50048 | .29 | .32 |
| € | 109,00 | 109,00 |



NAPIE

Coppia supporti mensola

Shelf wall bearing (1 pair) / Paire de supports pour tablette / Paar Halter für Ablage

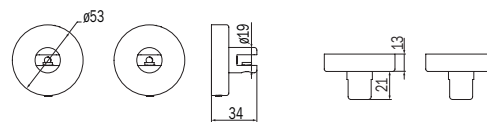

Acciaio inox lucido
Polished stainless steel
Acier Inoxydable brillant
Edelstahl Glänzend



53144

€

Acciaio inox spazzolato
Brushed stainless steel
Acier inoxydable brossé
Edelstahl Gebürstet



.32

50,00

.29

45,00

Mensola vetro temperato 392 mm

Glass shelf 392 mm / Etagère en verre 392 mm / Glasablage 392 mm

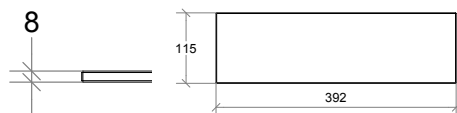

Vetro acidato
Etched glass
Verre dépoli
Geätztes Glas

5276

€

.81

38,00

Mensola vetro temperato 492 mm

Glass shelf 492 mm / Etagère en verre 492 mm / Glasablage 492 mm

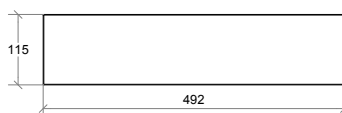

Vetro acidato
Etched glass
Verre dépoli
Geätztes Glas

5277

€

.81

41,00

Mensola vetro temperato 592 mm

Glass shelf 592 mm / Etagère en verre 592 mm / Glasablage 592 mm

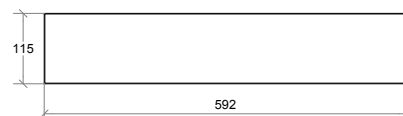

Vetro acidato
Etched glass
Verre dépoli
Geätztes Glas

5278

€

.81

46,00

Mensola vetro temperato 792 mm

Glass shelf 792 mm / Etagère en verre 792 mm / Glasablage 792 mm

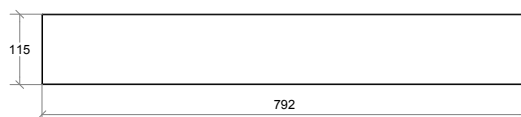

Vetro acidato
Etched glass
Verre dépoli
Geätztes Glas

5279

€

.81

54,00

NAPIE

Maniglione di sicurezza

Safety grab-bar / Barre d'appui de sécurité / Sicherheitshandgriff

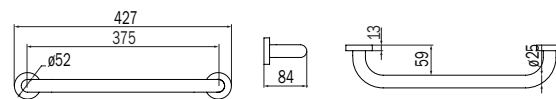

Acciaio inox lucido
Polished stainless steel
Acier Inoxydable brillant
Edelstahl Glänzend

Acciaio inox spazzolato
Brushed stainless steel
Acier inoxydable brossé
Edelstahl Gebürstet



53142

.29

.32

€

62,00

67,00



Cestino

Basket / Panier / Seifenkorb

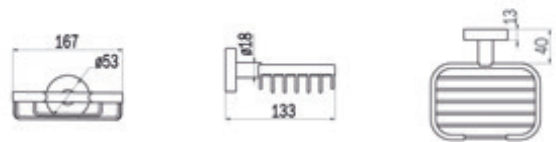

Acciaio inox lucido
Polished stainless steel
Acier Inoxydable brillant
Edelstahl Glänzend

Acciaio inox spazzolato
Brushed stainless steel
Acier inoxydable brossé
Edelstahl Gebürstet



53143

.29

.32

€

50,00

56,00



NAPIE

DUEMILA

ACCESSORI _ Accessories _ Accessoires _ Accessoires



DUEMILA: esattamente come la generazione dei millennials.

Snella, semplice, funzionale per quel che basta. Coetanea di coloro che, facendo spesso di necessità virtù, hanno scelto di essere cittadini del mondo.

EN

DUEMILA: exactly like the generation of millennials.

Essentially lean, simple, and functional. The same age as those who, often making a virtue of the necessity, have chosen to be citizens of the world.

FR

DUEMILA : comme la génération des millennials.

Élancée, simple, fonctionnelle juste ce qu'il faut. De la même génération que ceux qui, souvent par nécessité, ont choisi d'être citoyens du monde. Elle permet le choix du collage ou de la fixation traditionnelle, juste pour agrandir le champ des possibles.

DE

DUEMILA: genau wie die Generation der Millennials.

Schlank, einfach, gerade so funktionell wie nötig. Im gleichen Alter wie jene, die häufig aus der Not eine Tugend machten und entschieden haben, Weltbürger zu werden.

FINITURE _ Finishes _ Finitions _ Ausführung:

Ottone cromato con inserti in vetro o porcellana

Chromed brass with ceramic or glass inserts

Laiton chromé avec accessoires en céramique ou en verre

Verchromtes Messing mit Einsätzen aus Keramik oder Glas

Ottone cromato

Chromed brass

Laiton chromé

Verchromtes Messing



.29

Fissaggio con viti a muro o a incollo _ Screwed or glued to the wall _ Fixation au mur avec vis ou avec colle _ Wandbefestigung mit Schrauben oder Kleben



DUEMILA

Portarotolo

Toilet paper holder / Porte-rouleau / Toilettenpapierhalter

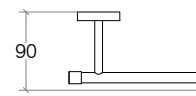
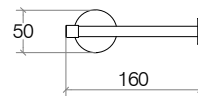

Ottone cromato
Chromed brass
Laiton chromé
Verchromtes Messing



R225000 **non incluso / da ordinare separatamente € 12,00**
not included / to be additionally ordered € 12,00
non inclus / à commander séparément € 12,00
Nicht Enthalten / Separat Bestellen € 12,00



| | |
|-------------|------------|
| 5504 | .29 |
| € | 41,00 |

Portarotolo

Toilet paper holder / Porte-rouleau / Toilettenpapierhalter

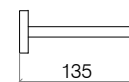
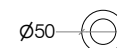

Ottone cromato
Chromed brass
Laiton chromé
Verchromtes Messing



R225000 **non incluso / da ordinare separatamente € 12,00**
not included / to be additionally ordered € 12,00
non inclus / à commander séparément € 12,00
Nicht Enthalten / Separat Bestellen € 12,00



| | |
|-------------|------------|
| 5508 | .29 |
| € | 36,00 |

Portarotolo doppio

Double toilet paper holder / Porte-rouleau double / Toilettenpapierhalter doppelt

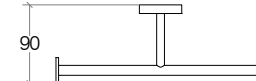
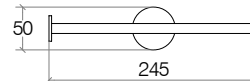

Ottone cromato
Chromed brass
Laiton chromé
Verchromtes Messing



R225000 **non incluso / da ordinare separatamente € 12,00**
not included / to be additionally ordered € 12,00
non inclus / à commander séparément € 12,00
Nicht Enthalten / Separat Bestellen € 12,00



| | |
|-------------|------------|
| 5505 | .29 |
| € | 47,00 |

Coppia appendini

2 Hooks / Jeu de 2 patères / Paar Hacken



Ottone cromato
Chromed brass
Laiton chromé
Verchromtes Messing



R225000 **non incluso / da ordinare separatamente € 12,00**
not included / to be additionally ordered € 12,00
non inclus / à commander séparément € 12,00
Nicht Enthalten / Separat Bestellen € 12,00



| | |
|-------------|------------|
| 5507 | .29 |
| € | 46,00 |

Portasalviette 300 mm

Towel rail 300 mm / Porte-serviettes 300 mm / Handtuchhalter 300 mm

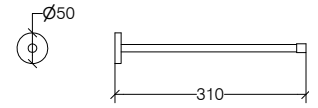

Ottone cromato
Chromed brass
Laiton chromé
Verchromtes Messing



R225000 **non incluso / da ordinare separatamente € 12,00**
not included / to be additionally ordered € 12,00
non inclus / à commander séparément € 12,00
Nicht Enthalten / Separat Bestellen € 12,00

| | |
|-------------|------------|
| 5511 | .29 |
| € | 41,00 |

Portasalviette 400 mm

Towel rail 400 mm / Porte-serviettes 400 mm / Handtuchhalter 400 mm

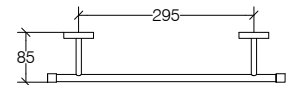
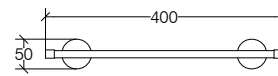

Ottone cromato
Chromed brass
Laiton chromé
Verchromtes Messing



R225000 **non incluso / da ordinare separatamente € 12,00**
not included / to be additionally ordered € 12,00
non inclus / à commander séparément € 12,00
Nicht Enthalten / Separat Bestellen € 12,00

| | |
|-------------|------------|
| 5512 | .29 |
| € | 60,00 |

Portasalviette 500 mm

Towel rail 500 mm / Porte-serviettes 500 mm / Handtuchhalter 500 mm

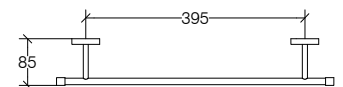
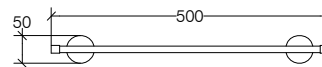

Ottone cromato
Chromed brass
Laiton chromé
Verchromtes Messing



R225000 **non incluso / da ordinare separatamente € 12,00**
not included / to be additionally ordered € 12,00
non inclus / à commander séparément € 12,00
Nicht Enthalten / Separat Bestellen € 12,00

| | |
|-------------|------------|
| 5513 | .29 |
| € | 68,00 |

Portasalviette 600 mm

Towel rail 600 mm / Porte-serviettes 600 mm / Handtuchhalter 600 mm

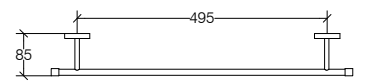
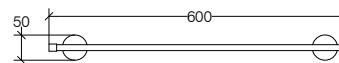

Ottone cromato
Chromed brass
Laiton chromé
Verchromtes Messing



R225000 **non incluso / da ordinare separatamente € 12,00**
not included / to be additionally ordered € 12,00
non inclus / à commander séparément € 12,00
Nicht Enthalten / Separat Bestellen € 12,00

| | |
|-------------|------------|
| 5514 | .29 |
| € | 72,00 |

DUEMILA

Portasalviette doppio snodato

Double jointed towel rail / Porte-serviettes articulé double / Doppelhandtuchhalter schwenkbar

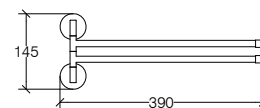
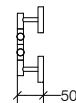

Ottone cromato
Chromed brass
Laiton chromé
Verchromtes Messing



R225000



non incluso / da ordinare separatamente € 12,00
not included / to be additionally ordered € 12,00
non inclus / à commander séparément € 12,00
Nicht Enthalten / Separat Bestellen € 12,00

5517

.29

€

87,00

Anello portasalviette

Towel ring / Anneau porte-serviettes / Handtuchring

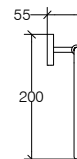
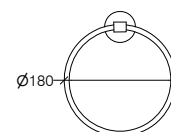

Ottone cromato
Chromed brass
Laiton chromé
Verchromtes Messing



non incluso / da ordinare separatamente € 12,00
not included / to be additionally ordered € 12,00
non inclus / à commander séparément € 12,00
Nicht Enthalten / Separat Bestellen € 12,00

5509

.29

€

47,00

Supporto singolo

Single holder / Support individuel / Halter lose

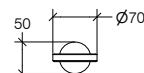

Ottone cromato
Chromed brass
Laiton chromé
Verchromtes Messing



R225000

non incluso / da ordinare separatamente € 12,00
not included / to be additionally ordered € 12,00
non inclus / à commander séparément € 12,00
Nicht Enthalten / Separat Bestellen € 12,00

55001

.29

€

34,00

Supporto doppio

Double holder / Support double / Halter doppelt

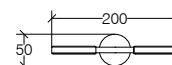

Ottone cromato
Chromed brass
Laiton chromé
Verchromtes Messing



R225000

non incluso / da ordinare separatamente € 12,00
not included / to be additionally ordered € 12,00
non inclus / à commander séparément € 12,00
Nicht Enthalten / Separat Bestellen € 12,00

55002

.29

€

41,00

DUEMILA

Bicchieri

Tumbler / Verre / Becher

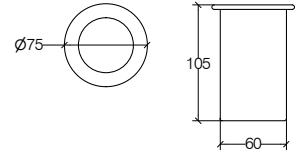

Porcellana
Porcelaine
Porcelaine
Porzellan



Vetro acidato
Etched glass
Verre dépoli
Geätztes Glas



| | | |
|--------------|------------|------------|
| 55003 | .09 | .81 |
| € | 20,00 | 20,00 |

Portasapone

Soap dish / Porte-savon / Seifenschale

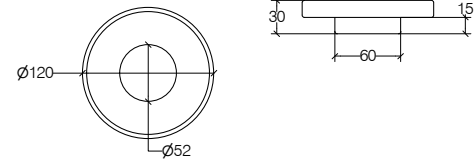

Porcellana
Porcelaine
Porcelaine
Porzellan



Vetro acidato
Etched glass
Verre dépoli
Geätztes Glas



| | | |
|--------------|------------|------------|
| 55004 | .09 | .81 |
| € | 20,00 | 20,00 |

Dosasapone 200 ml

Soap dispenser 200 ml / Distributeur savon liquide 200 ml / Seifenspender 200 ml

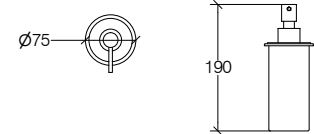

Ottone cromato
Chromed brass
Laiton chromé
Verchromtes Messing



Ottone verniciato
Painted brass
Laiton laqué
Lackiertem Messing



Ottone cromato
Chromed brass
Laiton chromé
Verchromtes Messing



Ottone verniciato
Painted brass
Laiton laqué
Lackiertem Messing



Porcellana
Porcelaine
Porcelaine
Porzellan

Vetro acidato
Etched glass
Verre dépoli
Geätztes Glas

| | | | | |
|--------------|------------|---------------|------------|---------------|
| 55006 | .09 | .09.23 | .81 | .81.23 |
| € | 50,00 | 50,00 | 50,00 | 50,00 |

Griglietta in silicone antiscivolo per Art. 55004 (20 pezzi assortiti in 4 colori)

20 grip grids for soap dish 55004 / Grille en silicon 20 picks pour porte savon 55004
20 Einlagen für Seifenschale 55004

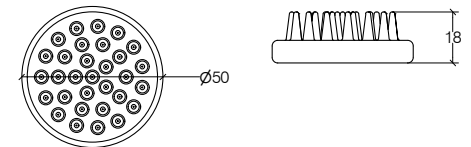

Silicone
Silicon
Silicone
Silikon



| | | | | |
|-------------|------------|------------|------------|------------|
| 5200 | .09 | .15 | .16 | .17 |
| € | | 48,00 | | |

DUEMILA

Dosapone a parete 220 ml

Wall soap dispenser 220 ml / Distributeur savon liquide mural 220 ml / Wandseifenspender 220 ml

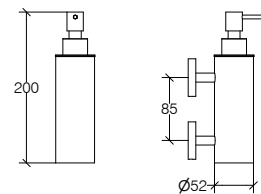

Ottone cromato
Chromed brass
Laiton chromé
Verchromtes Messing



| | |
|--------------|------------|
| 55032 | .29 |
| € | 87,00 |

Supporto portascopino a parete

Wall toilet brush holder / Support porte-balai mural / Halter lose für Toilettenbürsten am Wand



Ottone cromato
Chromed brass
Laiton chromé
Verchromtes Messing



| | |
|--------------|------------|
| 55061 | .29 |
| € | 41,00 |

Portascopino

Toilet brush / Porte-balai / Toilettenbürstengarnitur

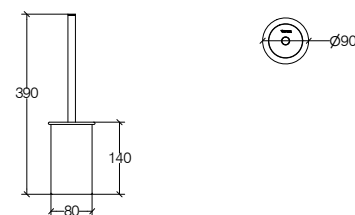

Ottone cromato
Chromed brass
Laiton chromé
Verchromtes Messing

Ottone verniciato
Painted brass
Laiton laqué
Lackiertem Messing

Ottone cromato
Chromed brass
Laiton chromé
Verchromtes Messing

Ottone verniciato
Painted brass
Laiton laqué
Lackiertem Messing

Porcellana
Porcelaine
Porcelaine
Porzellan

Vetro acidato
Etched glass
Verre dépoli
Geätztes Glas

| | | | | |
|--------------|------------|---------------|------------|---------------|
| 55062 | .09 | .09.23 | .81 | .81.23 |
| € | 51,00 | 51,00 | 51,00 | 51,00 |

Coppia supporti mensola

Shelf wall bearing (1 pair) / Paire de supports pour tablette / Paar Halter für Ablage

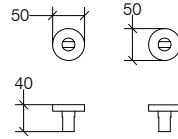

Ottone cromato
Chromed brass
Laiton chromé
Verchromtes Messing



5526

.29

€

48,00



Mensola vetro temperato 392 mm

Glass shelf 392 mm / Etagère en verre 392 mm / Glasablage 392 mm

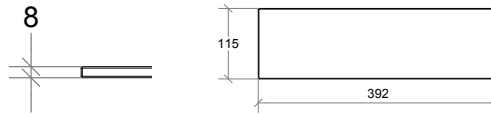

Vetro acidato
Etched glass
Verre dépoli
Geätztes Glas

5276

.81

€

38,00

Mensola vetro temperato 492 mm

Glass shelf 492 mm / Etagère en verre 492 mm / Glasablage 492 mm

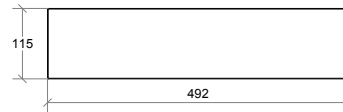

Vetro acidato
Etched glass
Verre dépoli
Geätztes Glas

5277

.81

€

41,00

Mensola vetro temperato 592 mm

Glass shelf 592 mm / Etagère en verre 592 mm / Glasablage 592 mm

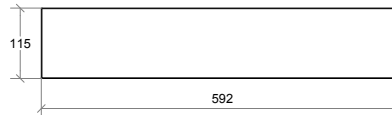

Vetro acidato
Etched glass
Verre dépoli
Geätztes Glas

5278

.81

€

46,00

Mensola vetro temperato 792 mm

Glass shelf 792 mm / Etagère en verre 792 mm / Glasablage 792 mm

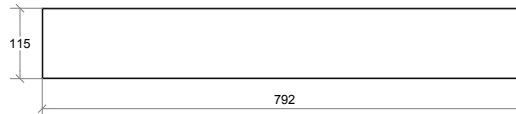

Vetro acidato
Etched glass
Verre dépoli
Geätztes Glas

5279

.81

€

54,00

Portascopino da pavimento e a parete

Floor and wall toilet brush holder / Porte-balai mural ou à poser / Wand oder Boden WC Bürstengarнитur

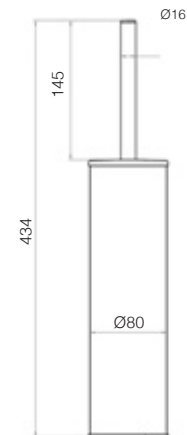

Acciaio inox lucido
Polished stainless steel
Acier inox brillant
Glänzer Edelstahl



50048

.29

€

109,00



DUEMILA

TA DUEMILA FIX

5512.29

Portasalviette 400 mm

Towel rail 400 mm / Porte-serviettes 400 mm / Handtuchhalter 400 mm

5507.29

Coppia appendini

2 Hooks / Jeu de 2 patères / Paar Hacken

5504.29

Portarotolo

Toilet paper holder / Porte-rouleau / Toilettenpapierhalter

55061.29+55062.09

Portascopino

Toilet brush / Porte-balai / Toilettenbürstengarnitur

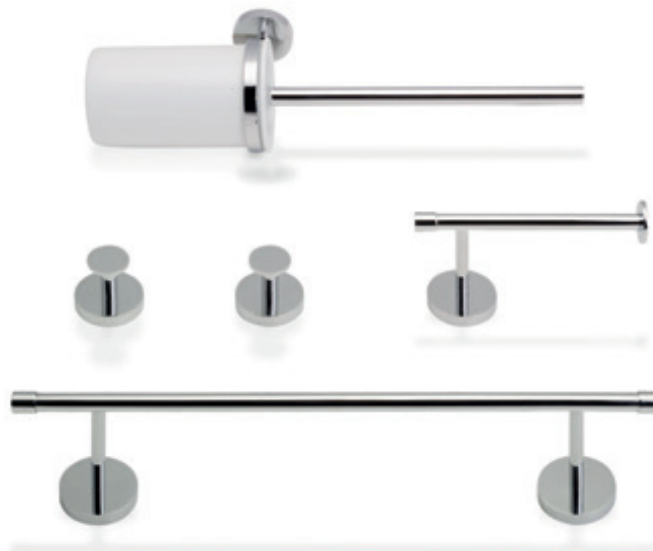

Ottone cromato
Chromed brass
Laiton chromé
Verchromtes Messing

TA-DUEMILAFIX

€

219,00



TA DUEMILA FIX BIS

5512.29

Portasalviette 400 mm

Towel rail 400 mm / Porte-serviettes 400 mm / Handtuchhalter 400 mm

5507.29

Coppia appendini

2 Hooks / Jeu de 2 patères / Paar Hacken

5504.29

Portarotolo

Toilet paper holder / Porte-rouleau / Toilettenpapierhalter

50048.29

Portascopino

Toilet brush / Porte-balai / Toilettenbürstengarnitur

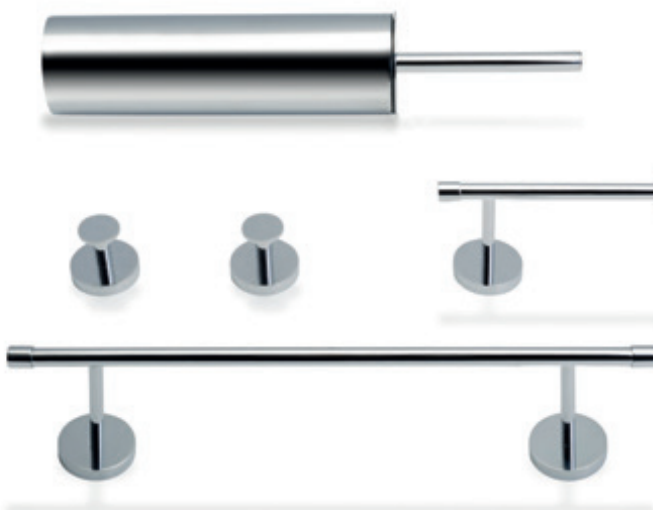

Ottone cromato
Chromed brass
Laiton chromé
Verchromtes Messing

TA-DUEMILAFIXBIS

€

231,00



DUEMILA



DUEMILA

SBECA

ACCESSORI _ Accessories _ Accessoires _ Accessoires



SBECÀ: dal dialetto veneto significa sbeccato, oggetto che presenta una o più scheggiature.

La collezione è disponibile in cromo e nero opaco, contraddistinta da un incavo angolare che la rende facilmente riconoscibile ed esclusiva.

EN

SBECÀ: in Venetian dialect it means chipped; it indicates an object that has one or more chips.

It is the new accessory collection available in chrome and matt black, characterized by an angular recess that makes it easily recognizable and exclusive.

FR

SBECÀ : du dialecte vénitien qui signifie ébréché, un objet qui présente un ou plusieurs impacts.

Il s'agit de la nouvelle collection d'accessoires disponible en chromé et en noir mat, caractérisée par un renforcement dans l'angle qui la rend facilement reconnaissable et exclusive.

DE

SBECÀ: im venetischen Dialekt ein Gegenstand, der eine oder mehrere Absplitterungen aufweist.

Die Zubehörsammlung ist in Chrom und matt schwarz erhältlich und zeichnet sich durch eine eckige Aussparung aus, die für Wiedererkennungswert und Exklusivität sorgt.

FINITURE _ Finishes _ Finitions _ Ausführung

Ottone cromato
Chromed brass
Laiton chromé
Verchromtes Messing



.29

Ottone verniciato nero opaco
Matt black painted brass
Laiton verni noir mat
Matt Schwarz Lackiertem Messing



.23

Fissaggio con viti a muro o a incollo _ Screwed or glued to the wall _ Fixation au mur avec vis ou avec colle _ Wandbefestigung mit Schrauben oder Kleben



SBECA

Portarotolo

Toilet paper holder / Porte-rouleau / Toilettenpapierhalter

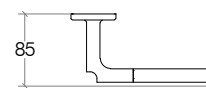
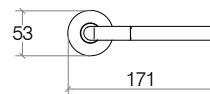

Ottone cromato
Chromed brass
Laiton chromé
Verchromtes Messing

Ottone verniciato
Painted brass
Laiton laqué
Lackiertem Messing



61104

.29

.23

€

45,00

47,00

R225000



non incluso / da ordinare separatamente € 12,00
not included / to be additionally ordered € 12,00
non inclus / à commander séparément € 12,00
Nicht Enthalten / Separat Bestellen € 12,00

Portarotolo coperto

Toilet paper holder with lid / Porte-rouleau avec couvercle / Toilettenpapierhalter mit Deckel

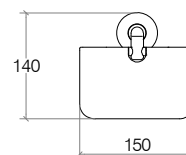

Ottone cromato
Chromed brass
Laiton chromé
Verchromtes Messing

Ottone verniciato
Painted brass
Laiton laqué
Lackiertem Messing



61105

.29

.23

€

71,00

74,00

non incluso / da ordinare separatamente € 12,00
not included / to be additionally ordered € 12,00
non inclus / à commander séparément € 12,00
Nicht Enthalten / Separat Bestellen € 12,00

Coppia appendini

2 Hooks / Jeu de 2 patères / Paar Hacken

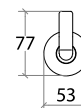

Ottone cromato
Chromed brass
Laiton chromé
Verchromtes Messing

Ottone verniciato
Painted brass
Laiton laqué
Lackiertem Messing



61107

.29

.23

€

57,00

60,00

R225000



non incluso / da ordinare separatamente € 12,00
not included / to be additionally ordered € 12,00
non inclus / à commander séparément € 12,00
Nicht Enthalten / Separat Bestellen € 12,00

Portasalviette 350 mm

Towel rail 350 mm / Porte-serviettes 350 mm / Handtuchhalter 350 mm

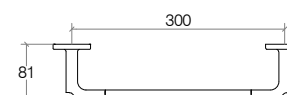
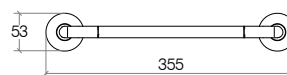

Ottone cromato
Chromed brass
Laiton chromé
Verchromtes Messing

Ottone verniciato
Painted brass
Laiton laqué
Lackiertem Messing



61108

.29

.23

€

60,00

63,00

R225000



non incluso / da ordinare separatamente € 12,00
not included / to be additionally ordered € 12,00
non inclus / à commander séparément € 12,00
Nicht Enthalten / Separat Bestellen € 12,00

Portasalviette 500 mm

Towel rail 500 mm / Porte-serviettes 500 mm / Handtuchhalter 500 mm

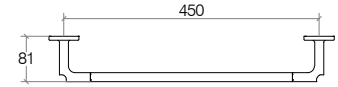
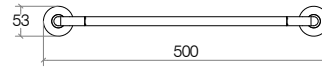

Ottone cromato
Chromed brass
Laiton chromé
Verchromtes Messing

Ottone verniciato
Painted brass
Laiton laqué
Lackiertem Messing



R225000 **non incluso / da ordinare separatamente € 12,00**
not included / to be additionally ordered € 12,00
non inclus / à commander séparément € 12,00
Nicht Enthalten / Separat Bestellen € 12,00

| | | |
|--------------|------------|------------|
| 61109 | .29 | .23 |
| € | 68,00 | 72,00 |

Portasalviette 650 mm

Towel rail 650 mm / Porte-serviettes 650 mm / Handtuchhalter 650 mm

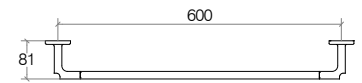
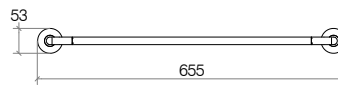

Ottone cromato
Chromed brass
Laiton chromé
Verchromtes Messing

Ottone verniciato
Painted brass
Laiton laqué
Lackiertem Messing



R225000 **non incluso / da ordinare separatamente € 12,00**
not included / to be additionally ordered € 12,00
non inclus / à commander séparément € 12,00
Nicht Enthalten / Separat Bestellen € 12,00

| | | |
|--------------|------------|------------|
| 61110 | .29 | .23 |
| € | 73,00 | 76,00 |

Portasalviette 850 mm

Towel rail 850 mm / Porte-serviettes 850 mm / Handtuchhalter 850 mm

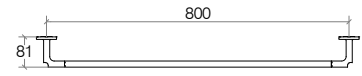
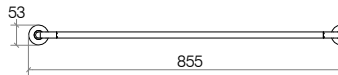

Ottone cromato
Chromed brass
Laiton chromé
Verchromtes Messing

Ottone verniciato
Painted brass
Laiton laqué
Lackiertem Messing



R225000 **non incluso / da ordinare separatamente € 12,00**
not included / to be additionally ordered € 12,00
non inclus / à commander séparément € 12,00
Nicht Enthalten / Separat Bestellen € 12,00

| | | |
|--------------|------------|------------|
| 61111 | .29 | .23 |
| € | 80,00 | 84,00 |

Anello portasalviette

Towel ring / Anneau porte-serviettes / Handtuchring

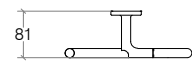
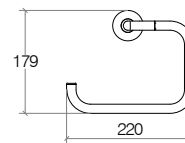

Ottone cromato
Chromed brass
Laiton chromé
Verchromtes Messing

Ottone verniciato
Painted brass
Laiton laqué
Lackiertem Messing



R225000 **non incluso / da ordinare separatamente € 12,00**
not included / to be additionally ordered € 12,00
non inclus / à commander séparément € 12,00
Nicht Enthalten / Separat Bestellen € 12,00

| | | |
|--------------|------------|------------|
| 61115 | .29 | .23 |
| € | 70,00 | 73,00 |

SBECA

Portabicchiere con bicchiere

Holder with tumbler / Support avec verre / Halter mit Becher

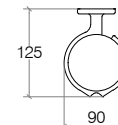
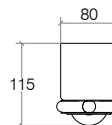

Ottone cromato
Chromed brass
Laiton chromé
Verchromtes Messing

Ottone verniciato
Painted brass
Laiton laqué
Lackiertem Messing

Vetro acidato
Etched glass
Verre dépoli
Geätztes Glas



61101

.29.81

.23.81

€

60,00

63,00

R225000

non incluso / da ordinare separatamente € 12,00
not included / to be additionally ordered € 12,00
non inclus / à commander séparément € 12,00
Nicht Enthalten / Separat Bestellen € 12,00



Portasapone con piattino

Holder with soap dish / Support avec porte-savon / Halter mit Seifenschale

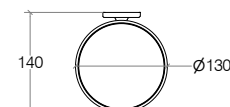

Ottone cromato
Chromed brass
Laiton chromé
Verchromtes Messing

Ottone verniciato
Painted brass
Laiton laqué
Lackiertem Messing

Vetro acidato
Etched glass
Verre dépoli
Geätztes Glas



61102

.29.81

.23.81

€

60,00

63,00

R225000

non incluso / da ordinare separatamente € 12,00
not included / to be additionally ordered € 12,00
non inclus / à commander séparément € 12,00
Nicht Enthalten / Separat Bestellen € 12,00



Portasapone con dosasapone 250 ml

Holder with soap dispenser 250 ml / Support avec distributeur savon liquide 250 ml / Halter mit Seifenspender 250 ml

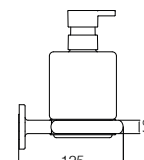
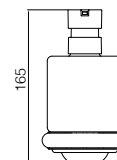

Ottone cromato
Chromed brass
Laiton chromé
Verchromtes Messing

Ottone verniciato
Painted brass
Laiton laqué
Lackiertem Messing

Vetro acidato
Etched glass
Verre dépoli
Geätztes Glas



61103

.29.81

.23.81

€

78,00

81,00



Portascopino da pavimento e a parete

Floor and wall toilet brush holder / Porte-balai mural ou à poser / Wand oder Boden WC Bürstengarnitur

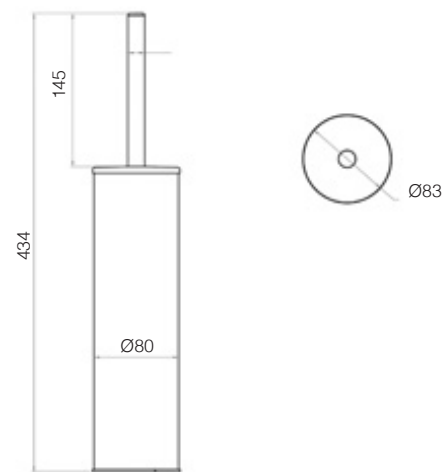

Acciaio inox lucido
Polished stainless steel
Acier inox brillant
Glänzender Edelstahl

Acciaio verniciato
Painted steel
Acier laqué
Lackiertes edelstahl



| | | |
|--------------|------------|------------|
| 50048 | .29 | .23 |
| € | 109,00 | 98,00 |



PICOLA
ACCESSORI _ Accessories _ Accessoires _ Accessoires



PICOLA: piccolina, l'ultima nata in famiglia, quella che gode della simpatia e delle attenzioni di tutti gli altri membri.

Una serie discreta, amata in particolar modo dagli architetti. Non "ruba il palcoscenico", ma lascia spazio alle velleità architettoniche di chi progetta la casa e il bagno.

EN

PICOLA: small, the baby of the family, the one who enjoys the sympathy and attention of all the other members.

A discreet range, loved especially by architects. It does not "steal the stage", but leaves room for the architectural ambitions of those who design the house and the bathroom.

FR

PICOLA : petite fille, la dernière arrivée dans la famille, celle qui bénéficie de la sympathie et de l'attention de tous les autres membres.

Une série discrète, particulièrement appréciée des architectes. Elle ne « vole pas la vedette », mais laisse place aux ambitions architecturales de ceux qui décorent les intérieurs et les salles de bains.

DE

PICOLA: die Kleine, die Letztgeborene der Familie, jene, die die Zuneigung und Aufmerksamkeit aller anderen Familienmitglieder genießt.

Eine dezente Serie, die besonders von den Architekten geliebt wird. Sie "stiehlt nicht die Schau", sondern lässt den architektonischen Ambitionen dessen Raum, der das Haus und das Bad entwirft.

FINITURE _ Finishes _ Finitions _ Ausführung

Ottone cromato con inserti in vetro o porcellana

Chromed brass with ceramic or glass inserts

Laiton chromé avec accessoires en céramique ou en verre

Verchromtes Messing mit Einsätzen aus Keramik oder Glas

Ottone cromato
Chromed brass
Laiton chromé
Verchromtes Messing



.29

Fissaggio con viti a muro _ Screwed to the wall _ Fixation au mur avec vis _ Wandbefestigung mit Schrauben



PICOLA

Portarotolo

Toilet paper holder / Porte-rouleau / Toilettenpapierhalter

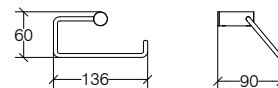

Ottone cromato
Chromed brass
Laiton chromé
Verchromtes Messing



| | |
|--------------|------------|
| 52535 | .29 |
| € | 47,00 |

Portarotolo

Toilet paper holder / Porte-rouleau / Toilettenpapierhalter

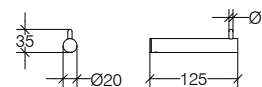

Ottone cromato
Chromed brass
Laiton chromé
Verchromtes Messing



| | |
|-------------|------------|
| 5254 | .29 |
| € | 37,00 |

Portarotolo con riserva

Toilet paper holder with reserve / Porte-rouleau réserve / Toilettenpapier Ersatzrollenhalter

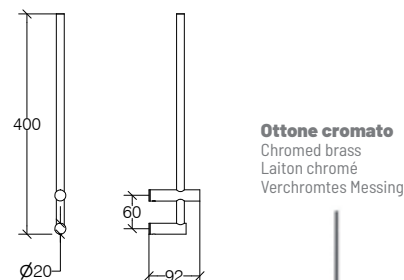

Ottone cromato
Chromed brass
Laiton chromé
Verchromtes Messing



| | |
|-------------|------------|
| 5255 | .29 |
| € | 61,00 |

Coppia appendini

2 Hooks / Jeu de 2 patères / Paar Hacken

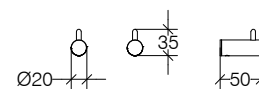

Ottone cromato
Chromed brass
Laiton chromé
Verchromtes Messing



| | |
|-------------|------------|
| 5258 | .29 |
| € | 37,00 |

PICOLA

Portasalviette 400 mm

Towel rail 400 mm / Porte-serviettes 400 mm / Handtuchhalter 400 mm

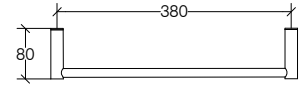
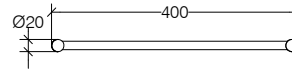

Ottone cromato
Chromed brass
Laiton chromé
Verchromtes Messing



| | |
|-------------|--------------|
| 5260 | .29 |
| € | 67,00 |

Portasalviette 600 mm

Towel rail 600 mm / Porte-serviettes 600 mm / Handtuchhalter 600 mm

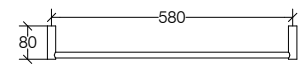
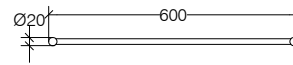

Ottone cromato
Chromed brass
Laiton chromé
Verchromtes Messing



| | |
|-------------|--------------|
| 5262 | .29 |
| € | 71,00 |

Portasalviette doppio

Double towel rail / Porte-serviettes double / Handtuchhalter doppelt

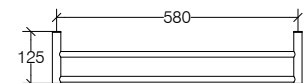
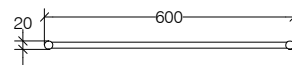

Ottone cromato
Chromed brass
Laiton chromé
Verchromtes Messing



| | |
|-------------|---------------|
| 5264 | .29 |
| € | 114,00 |

Portasalviette doppio snodato

Double jointed towel rail / Porte-serviettes articulé double / Doppelhandtuchhalter schwenkbar

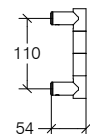
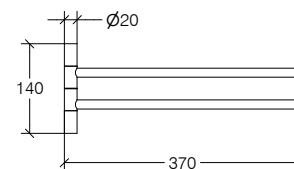

Ottone cromato
Chromed brass
Laiton chromé
Verchromtes Messing



| | |
|-------------|---------------|
| 5265 | .29 |
| € | 100,00 |

PICOLA

Anello portasalviette

Towel ring / Anneau porte-serviettes / Handtuchring

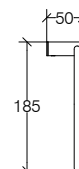
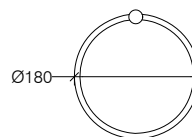

Ottone cromato
Chromed brass
Laiton chromé
Verchromtes Messing



5259

.29

€

48,00



Supporto singolo

Single holder / Support individuel / Halter lose

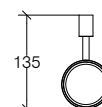
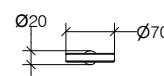

Ottone cromato
Chromed brass
Laiton chromé
Verchromtes Messing



52511

.29

€

39,00



Bicchieri

Tumbler / Verre / Becher

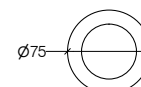
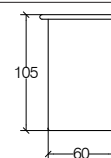

Porcellana
Porcelaine
Porcelaine
Porzellan



Vetro acidato
Etched glass
Verre dépoli
Geätztes Glas



55003

.09

.81

€

20,00

20,00

Portasapone

Soap dish / Porte-savon / Seifenschale

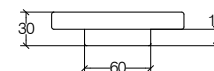
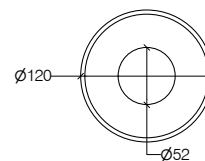

Porcellana
Porcelaine
Porcelaine
Porzellan



Vetro acidato
Etched glass
Verre dépoli
Geätztes Glas



55004

.09

.81

€

20,00

20,00

PICOLA

Dosasapone 200 ml

Soap dispenser 200 ml / Distributeur savon liquide 200 ml / Seifenspender 200 ml

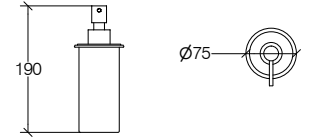

Ottone cromato
Chromed brass
Laiton chromé
Verchromtes Messing

Ottone cromato
Chromed brass
Laiton chromé
Verchromtes Messing

Porcellana
Porcelaine
Porcelaine
Porzellan

Vetro acidato
Etched glass
Verre dépoli
Geätztes Glas

| | | |
|--------------|------------|------------|
| 55006 | .09 | .81 |
| € | 50,00 | 50,00 |

Griglietta in silicone antiscivolo per Art. 55004 (20 pezzi assortiti in 4 colori)

20 grip grids for soap dish 55004 / Grille en silicon 20 picks pour porte savon 55004 / 20 Einlagen für Seifenschale 55004

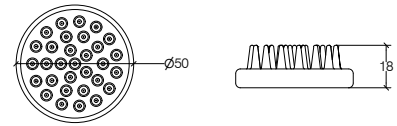

Silicone
Silicon
Silicone
Silikon

| | | | | |
|-------------|------------|------------|------------|------------|
| 5200 | .09 | .15 | .16 | .17 |
| € | 48,00 | | | |

Borchia per serie 'PICOLA'

Plate for 'PICOLA' range / Plaque murale collection 'PICOLA' / Scheibe für Serie 'PICOLA'



Ottone cromato
Chromed brass
Laiton chromé
Verchromtes Messing



| | |
|--------------|------------|
| 52510 | .29 |
| € | 8,00 |

Supporto portascopino a parete

Wall toilet brush holder / Support porte-balai mural / Toilettenbürstenhalter



Ottone cromato
Chromed brass
Laiton chromé
Verchromtes Messing



| | |
|--------------|------------|
| 52561 | .29 |
| € | 40,00 |

PICOLA

PICOLA

Portascopino

Toilet brush / Porte-balai / Toilettenbürstengarnitur

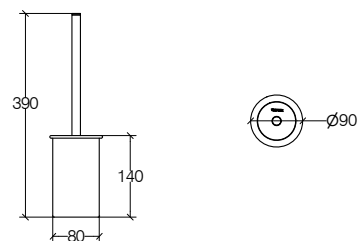

| 55062 | .09 | .81 |
|-------|-------|-------|
| € | 51,00 | 51,00 |

Porcellana
Porcelaine
Porcelaine
Porzellan

Ottone cromato
Chromed brass
Laiton chromé
Verchromtes Messing

Vetro acidato
Etched glass
Verre dépoli
Geätztes Glas

Portascopino da pavimento e a parete

Floor and wall toilet brush holder / Porte-balai mural ou à poser / Wand oder Boden WC Bürstengarnitur

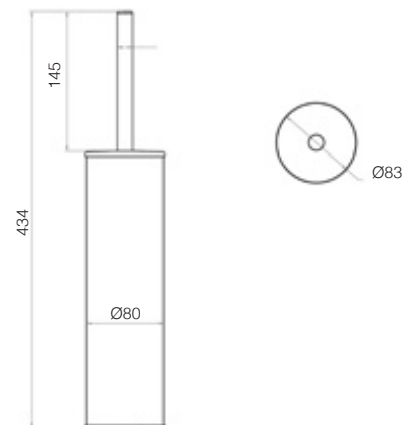

| 50048 | .29 |
|-------|--------|
| € | 109,00 |

Acciaio inox lucido
Polished stainless steel
Acier inox brillant
Glänzer Edelstahl



PICOLA

Coppia supporti mensola

Shelf wall bearing (1 pair) / Paire de supports pour tablette / Paar Halter für Ablage

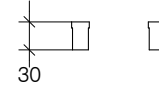

Ottone cromato
Chromed brass
Laiton chromé
Verchromtes Messing



| | |
|-------------|------------|
| 5273 | .29 |
| € | 33,00 |

Mensola vetro temperato 392 mm

Glass shelf 392 mm / Etagère en verre 392 mm / Glasablage 392 mm

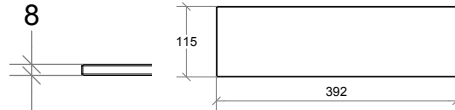

Vetro acidato
Etched glass
Verre dépoli
Geätztes Glas

| | |
|-------------|------------|
| 5276 | .81 |
| € | 38,00 |

Mensola vetro temperato 492 mm

Glass shelf 492 mm / Etagère en verre 492 mm / Glasablage 492 mm

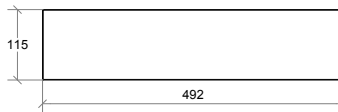

Vetro acidato
Etched glass
Verre dépoli
Geätztes Glas

| | |
|-------------|------------|
| 5277 | .81 |
| € | 41,00 |

Mensola vetro temperato 592 mm

Glass shelf 592 mm / Etagère en verre 592 mm / Glasablage 592 mm

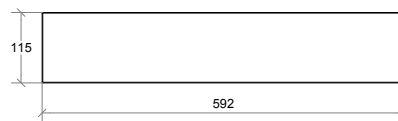

Vetro acidato
Etched glass
Verre dépoli
Geätztes Glas

| | |
|-------------|------------|
| 5278 | .81 |
| € | 46,00 |

Mensola vetro temperato 792 mm

Glass shelf 792 mm / Etagère en verre 792 mm / Glasablage 792 mm

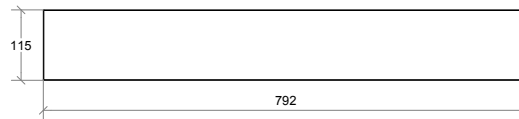

Vetro acidato
Etched glass
Verre dépoli
Geätztes Glas

| | |
|-------------|------------|
| 5279 | .81 |
| € | 54,00 |

TA-PICOLAFIX BIS

5260.29

Portasalviette 400 mm

Towel rail 400 mm / Porte-serviettes 400 mm / Handtuchhalter 400 mm

5258.29

Coppia appendini

2 Hooks / Jeu de 2 patères / Paar Hacken

5254.29

Portarotolo

Toilet paper holder / Porte-rouleau / Toilettenpapierhalter

50048.29

Portascopino

Toilet brush / Porte-balai / Toilettenbürstengarnitur

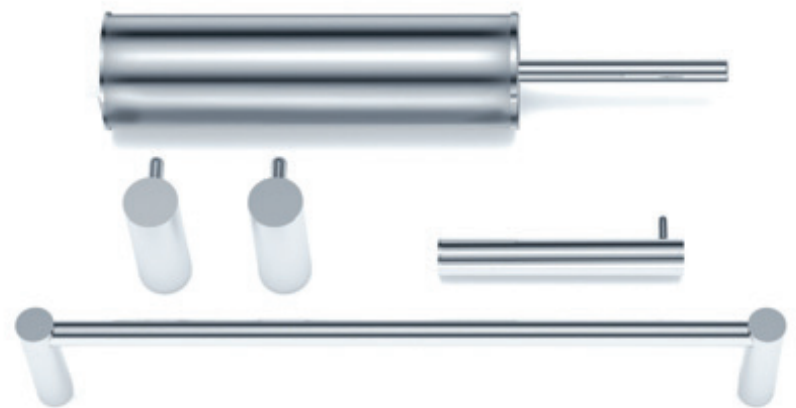

Ottone cromato
Chromed brass
Laiton chromé
Verchromtes Messing

| | |
|------------------------|--------|
| TA-PICOLAFIXBIS | |
| € | 235,00 |



VENESSIA

ACCESSORI _ Accessories _ Accessoires _ Accessoires



VENESSIA: Venezia, la nostra adorata città, capoluogo di regione.

Questa serie, proprio come la città della quale porta orgogliosamente il nome, è classica nello stile ma innovativa nei dettagli.
Designer: Royi Frame – Spiral Product Design London

EN

VENESSIA:

Venice, our beloved city and regional capital.

This range, just like the city whose name it proudly bears, is classic in style but innovative when it comes to details.

Designer: Royi Frame – Spiral Product Design London

FR

VENESSIA :

Venise, notre ville bien-aimée, capitale régionale.

Cette série, tout comme la ville dont elle porte fièrement le nom, est de style classique mais innovante dans les détails.

Designer : Royi Frame – Spiral Product Design – Londres

DE

VENESSIA:

Venedig, unsere bewunderte Stadt, Hauptstadt der Region Venetien.

Diese Serie ist genau wie die Stadt, deren Namen sie so stolz trägt, klassisch im Stil, aber innovativ in den Details.

Designer: Royi Frame – Spiral Product Design London

FINITURE _ Finishes _ Finitions _ Ausführung

Ottone cromato, oro con inserti in porcellana

Chromed or gold brass with ceramic inserts

Laiton chromé ou or avec accessoires en céramique

Verchromtes oder Gold Messing mit Einsätzen aus Keramik

Ottone cromato

Chromed brass

Laiton chromé

Verchromtes Messing



.29

Ottone oro

Gold brass

Laiton or

Gold Messing



.30

Fissaggio con viti a muro o a incollo _ Screwed or glued to the wall _ Fixation au mur avec vis ou avec colle _ Wandbefestigung mit Schrauben oder Kleben



VENESSIA

Portarotolo

Toilet paper holder / Porte-rouleau / Toilettenpapierhalter



R225000



non incluso / da ordinare separatamente € 12,00
not included / to be additionally ordered € 12,00
non inclus / à commander séparément € 12,00
Nicht Enthalten / Separat Bestellen € 12,00

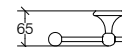
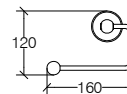

Ottone cromato
Chromed brass
Laiton chromé
Verchromtes Messing



Ottone oro
Gold brass
Laiton or
Gold Messing



| | | |
|--------------|------------|------------|
| 52908 | .29 | .30 |
| € | 64,00 | 95,00 |

Portarotolo coperto

Toilet paper holder with lid / Porte-rouleau avec couvercle / Toilettenpapierhalter mit Deckel



R225000



non incluso / da ordinare separatamente € 12,00
not included / to be additionally ordered € 12,00
non inclus / à commander séparément € 12,00
Nicht Enthalten / Separat Bestellen € 12,00

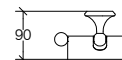
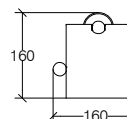

Ottone cromato
Chromed brass
Laiton chromé
Verchromtes Messing



Ottone oro
Gold brass
Laiton or
Gold Messing



| | | |
|--------------|------------|------------|
| 52907 | .29 | .30 |
| € | 92,00 | 130,00 |

Portarotolo con riserva

Toilet paper holder with reserve / Porte-rouleau réserve / Toilettenpapier Ersatzrollenhalter

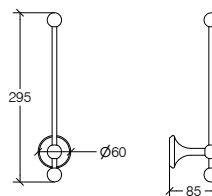

Ottone cromato
Chromed brass
Laiton chromé
Verchromtes Messing



Ottone oro
Gold brass
Laiton or
Gold Messing



| | | |
|--------------|------------|------------|
| 52910 | .29 | .30 |
| € | 64,00 | 92,00 |

Appendino

Hook / Patère / Hacken



R225000



non incluso / da ordinare separatamente € 12,00
not included / to be additionally ordered € 12,00
non inclus / à commander séparément € 12,00
Nicht Enthalten / Separat Bestellen € 12,00

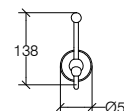

Ottone cromato
Chromed brass
Laiton chromé
Verchromtes Messing



Ottone oro
Gold brass
Laiton or
Gold Messing



| | | |
|--------------|------------|------------|
| 52938 | .29 | .30 |
| € | 49,00 | 76,00 |

VENESSIA

Appendino doppio

Double hook / Patère double / Doppelthacken

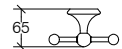
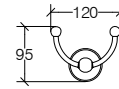

Ottone cromato
Chromed brass
Laiton chromé
Verchromtes Messing

Ottone oro
Gold brass
Laiton or
Gold Messing



52939

.29

.30

€

51,00

79,00

R225000

non incluso / da ordinare separatamente € 12,00

not included / to be additional y ordered € 12,00

non inclus / à commander séparément € 12,00

Nicht Enthalten / Separat Bestellen € 12,00



Griglia con portasalviette

Towel shelf / Rack porte-serviettes / Handtuchablage

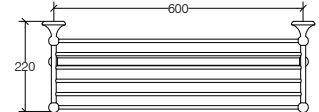
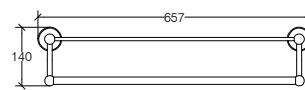

Ottone cromato
Chromed brass
Laiton chromé
Verchromtes Messing

Ottone oro
Gold brass
Laiton or
Gold Messing



52926

.29

.30

€

209,00

350,00



Portasalviette 457 mm

Towel rail 457 mm / Porte-serviettes 457 mm / Handtuchhalter 457 mm

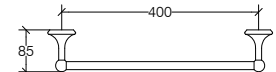
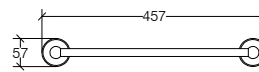

Ottone cromato
Chromed brass
Laiton chromé
Verchromtes Messing

Ottone oro
Gold brass
Laiton or
Gold Messing



52914

.29

.30

€

109,00

140,00

R225000

non incluso / da ordinare separatamente € 12,00

not included / to be additional y ordered € 12,00

non inclus / à commander séparément € 12,00

Nicht Enthalten / Separat Bestellen € 12,00



Portasalviette 657 mm

Towel rail 657 mm / Porte-serviettes 657 mm / Handtuchhalter 657 mm

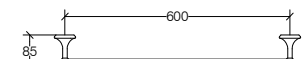
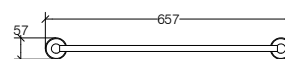

Ottone cromato
Chromed brass
Laiton chromé
Verchromtes Messing

Ottone oro
Gold brass
Laiton or
Gold Messing



52916

.29

.30

€

120,00

152,00

R225000

non incluso / da ordinare separatamente € 12,00

not included / to be additional y ordered € 12,00

non inclus / à commander séparément € 12,00

Nicht Enthalten / Separat Bestellen € 12,00



VENESSIA

Portasalviette doppio 657 mm

Double towel holder 657 mm / Porte-serviettes double 657 mm / Doppelhandtuchhalter 657 mm

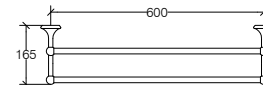
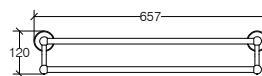

Ottone cromato
Chromed brass
Laiton chromé
Verchromtes Messing



Ottone oro
Gold brass
Laiton or
Gold Messing



| | | |
|--------------|------------|------------|
| 52917 | .29 | .30 |
| € | 142,00 | 186,00 |

Portasalviette snodato 340 mm

Jointed towel rail 340 mm / Porte-serviettes articulé 340 mm / Handtuchhalter schwenkbar 340 mm

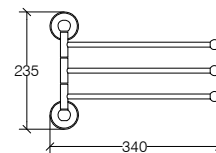

Ottone cromato
Chromed brass
Laiton chromé
Verchromtes Messing



Ottone oro
Gold brass
Laiton or
Gold Messing



| | | |
|--------------|------------|------------|
| 52920 | .29 | .30 |
| € | 130,00 | 202,00 |

Anello portasalviette

Towel ring / Anneau porte-serviettes / Handtuchring



R225000

non incluso / da ordinare separatamente € 12,00
not included / to be additionally ordered € 12,00
non inclus / à commander séparément € 12,00
Nicht Enthalten / Separat Bestellen € 12,00

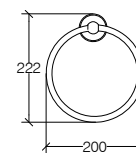

Ottone cromato
Chromed brass
Laiton chromé
Verchromtes Messing



Ottone oro
Gold brass
Laiton or
Gold Messing



| | | |
|--------------|------------|------------|
| 52921 | .29 | .30 |
| € | 51,00 | 81,00 |

Portabicchiere con bicchiere in porcellana

Holder with porcelain tumbler / Support avec verre en porcelaine / Halter mit Porzellan Becher



R225000

non incluso / da ordinare separatamente € 12,00
not included / to be additionally ordered € 12,00
non inclus / à commander séparément € 12,00
Nicht Enthalten / Separat Bestellen € 12,00

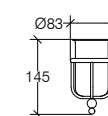

Ottone cromato
Chromed brass
Laiton chromé
Verchromtes Messing



Ottone oro
Gold brass
Laiton or
Gold Messing



| | | |
|--------------|------------|------------|
| 52901 | .29 | .30 |
| € | 75,00 | 115,00 |

VENESSIA

Portasapone con piattino in porcellana

Holder with porcelain soap dish / Support avec porte-savon en porcelaine / Halter mit Porzellan Seifenschale

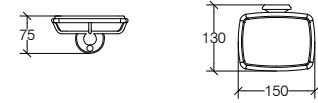

R225000



non incluso / da ordinare separatamente € 12,00
not included / to be additional y ordered € 12,00
non inclus / à commander séparément € 12,00
Nicht Enthalten / Separat Bestellen € 12,00

Ottone cromato
Chromed brass
Laiton chromé
Verchromtes Messing

Ottone oro
Gold brass
Laiton or
Gold Messing



| | | |
|--------------|------------|------------|
| 52902 | .29 | .30 |
| € | 97,00 | 130,00 |

Dosasapone a parete 200 ml

Wall soap dispenser 200 ml / Distributeur savon liquide mural 200 ml / Wandseifenspender 200 ml

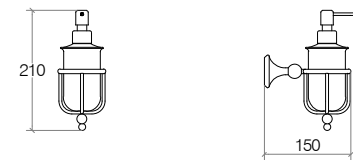

Ottone cromato
Chromed brass
Laiton chromé
Verchromtes Messing

Ottone oro
Gold brass
Laiton or
Gold Messing



| | | |
|--------------|------------|------------|
| 52904 | .29 | .30 |
| € | 114,00 | 154,00 |

Portascopino

Toilet brush / Porte-balai / Toilettenbürstengarnitur

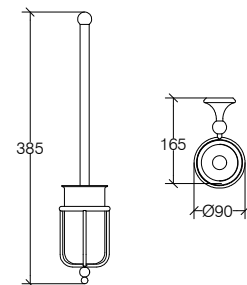

Ottone cromato
Chromed brass
Laiton chromé
Verchromtes Messing

Ottone oro
Gold brass
Laiton or
Gold Messing



| | | |
|--------------|------------|------------|
| 52906 | .29 | .30 |
| € | 114,00 | 190,00 |

VENESSIA

Coppia supporti mensola

Shelf wall bearing (1 pair) / Paire de supports pour étagère / Paar Halter für Ablage



Ottone cromato
Chromed brass
Laiton chromé
Verchromtes Messing

Ottone oro
Gold brass
Laiton or
Gold Messing



52932

.29

.30

€

48,00

73,00

R225000



non incluso / da ordinare separatamente € 12,00
not included / to be additionally ordered € 12,00
non inclus / à commander séparément € 12,00
Nicht Enthalten / Separat Bestellen € 12,00

Mensola vetro temperato 392 mm

Glass shelf 392 mm / Etagère en verre 392 m / Glasablage 392 mm



Vetro acidato
Etched glass
Verre dépoli
Geätztes Glas

5276

.81

€

38,00

Mensola vetro temperato 492 mm

Glass shelf 492 mm / Etagère en verre 492 m / Glasablage 492 mm

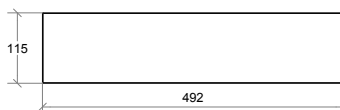

Vetro acidato
Etched glass
Verre dépoli
Geätztes Glas

5277

.81

€

41,00

Mensola vetro temperato 592 mm

Glass shelf 592 mm / Etagère en verre 592 m / Glasablage 592 mm

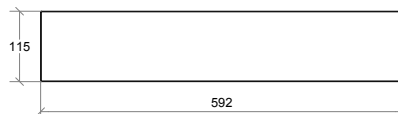

Vetro acidato
Etched glass
Verre dépoli
Geätztes Glas

5278

.81

€

46,00

Mensola vetro temperato 792 mm

Glass shelf 792 mm / Etagère en verre 792 m / Glasablage 792 mm

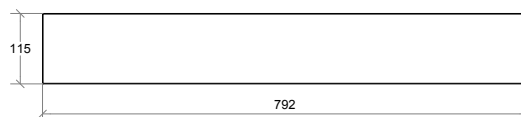

Vetro acidato
Etched glass
Verre dépoli
Geätztes Glas

5279

.81

€

54,00

Traversa vasca

Bathtub bridge / Porte-objets transversal pour baignoire / Badewannenauflage

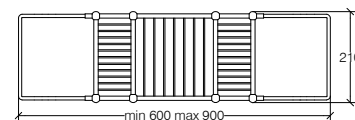

Ottone cromato
Chromed brass
Laiton chromé
Verchromtes Messing



52924

.29

€

185,00

VENESSIA



VENESSIA

Ricambi _ Spare parts _ Pièces détachées _ Ersatzteile

| | | | |
|-------|-------------|--|-------|
| 5152 | R2553951 | Pompetta completa in ottone cromato per dosatore in vetro e porcellana, Brass chromed pump for glass and porcelaine soap dispenser | 24,00 |
| | R22440181 | Flacone plastica interno Internal plastic container | 7,00 |
| 5161 | R2400454029 | Vite con tappo cromo - Screw with cromed cap | 8,00 |
| | R2400454032 | Vite con tappo satinato - Screw with satined cap | 8,00 |
| 5160 | R2400454029 | Vite con tappo cromo - Screw with cromed cap | 8,00 |
| | R2400454032 | Vite con tappo satinato - Screw with satined cap | 8,00 |
| 5164 | R2400454029 | Vite con tappo cromo - Screw with cromed cap | 8,00 |
| | R2400454032 | Vite con tappo satinato - Screw with satined cap | 8,00 |
| 5165 | R2400454029 | Vite con tappo cromo - Screw with cromed cap | 8,00 |
| | R2400454032 | Vite con tappo satinato - Screw with satined cap | 8,00 |
| 5169 | R2400454029 | Vite con tappo cromo - Screw with cromed cap | 8,00 |
| | R2400454032 | Vite con tappo satinato - Screw with satined cap | 8,00 |
| 5170 | R2400454029 | Vite con tappo cromo - Screw with cromed cap | 8,00 |
| | R2400454032 | Vite con tappo satinato - Screw with satined cap | 8,00 |
| 5171 | R2400454029 | Vite con tappo cromo - Screw with cromed cap | 8,00 |
| | R2400454032 | Vite con tappo satinato - Screw with satined cap | 8,00 |
| 5172 | R2400454029 | Vite con tappo cromo - Screw with cromed cap | 8,00 |
| | R2400454032 | Vite con tappo satinato - Screw with satined cap | 8,00 |
| 52894 | R2553951 | Pompetta completa in ottone cromato per dosatore in vetro e porcellana, Brass chromed pump for glass and porcelaine soap dispenser | 24,00 |
| | R22440021 | Tubetto in plastica per pompetta - Plastic tube for pump | 5,00 |
| | R2244002 | Tubetto per pompetta - Plastic tube for pump | 5,00 |
| 52806 | R2250002C | Confezione 2 viti 4x40 + 2 tasselli + 1 chiave - 2 screws 4x40 + 2 raw plug + Allan key set | 6,00 |
| | R20528084 | Kit piastrina + grano serie Skuara - Plate + screw kit Skuara | 8,00 |
| | R25528064 | Rullo portarotolo SKUARA - Toilet paper SKUARA roll | 16,00 |
| 52807 | R2250002C | Confezione 2 viti 4x40 + 2 tasselli + 1 chiave - 2 screws 4x40 + 2 raw plug + Allan key set | 6,00 |
| | R20528084 | Kit piastrina + grano serie Skuara - Plate + screw kit Skuara | 8,00 |
| | R25528064 | Rullo portarotolo SKUARA - Toilet paper SKUARA roll | 16,00 |
| 52853 | R2250002C | Confezione 2 viti 4x40 + 2 tasselli + 1 chiave - 2 screws 4x40 + 2 raw plug + Allan key set | 6,00 |
| | R20528084 | Kit piastrina + grano serie Skuara - Plate + screw kit Skuara | 8,00 |
| 52813 | R2250002C | Confezione 2 viti 4x40 + 2 tasselli + 1 chiave - 2 screws 4x40 + 2 raw plug + Allan key set | 6,00 |
| | R20528084 | Kit piastrina + grano serie Skuara - Plate + screw kit Skuara | 8,00 |
| 52814 | R2250002C | Confezione 2 viti 4x40 + 2 tasselli + 1 chiave - 2 screws 4x40 + 2 raw plug + Allan key set | 6,00 |
| | R20528084 | Kit piastrina + grano serie Skuara - Plate + screw kit Skuara | 8,00 |
| 52815 | R2250002C | Confezione 2 viti 4x40 + 2 tasselli + 1 chiave - 2 screws 4x40 + 2 raw plug + Allan key set | 6,00 |
| | R20528084 | Kit piastrina + grano serie Skuara - Plate + screw kit Skuara | 8,00 |
| 52816 | R2250002C | Confezione 2 viti 4x40 + 2 tasselli + 1 chiave - 2 screws 4x40 + 2 raw plug + Allan key set | 6,00 |
| | R20528084 | Kit piastrina + grano serie Skuara - Plate + screw kit Skuara | 8,00 |

Spare parts _ Pièces détachées _ Ersatzteile _ **Ricambi**

| | | | |
|-----------------|------------|--|-------|
| 52818 | R2250002C | Confezione 2 viti 4x40 + 2 tasselli + 1 chiave - 2 screws 4x40 + 2 raw plug + Allan key set | 6,00 |
| | R20528084 | Kit piastrina + grano serie Skuara - Plate + screw kit Skuara | 8,00 |
| 52808 | R2250002C | Confezione 2 viti 4x40 + 2 tasselli + 1 chiave - 2 screws 4x40 + 2 raw plug + Allan key set | 6,00 |
| | R20528084 | Kit piastrina + grano serie Skuara - Plate + screw kit Skuara | 8,00 |
| 52810 | R2250002C | Confezione 2 viti 4x40 + 2 tasselli + 1 chiave - 2 screws 4x40 + 2 raw plug + Allan key set | 6,00 |
| | R20528084 | Kit piastrina + grano serie Skuara - Plate + screw kit Skuara | 8,00 |
| 52811 | R2250002C | Confezione 2 viti 4x40 + 2 tasselli + 1 chiave - 2 screws 4x40 + 2 raw plug + Allan key set | 6,00 |
| | R20528084 | Kit piastrina + grano serie Skuara - Plate + screw kit Skuara | 8,00 |
| 52812 | R2250002C | Confezione 2 viti 4x40 + 2 tasselli + 1 chiave - 2 screws 4x40 + 2 raw plug + Allan key set | 6,00 |
| | R20528084 | Kit piastrina + grano serie Skuara - Plate + screw kit Skuara | 8,00 |
| 52834 | R2250002C | Confezione 2 viti 4x40 + 2 tasselli + 1 chiave - 2 screws 4x40 + 2 raw plug + Allan key set | 6,00 |
| | R20528084 | Kit piastrina + grano serie Skuara - Plate + screw kit Skuara | 8,00 |
| | 5276.81 | Mensola vetro temperato spessore 8 mm - Glass shelf thickness 8 mm | 38,00 |
| 52836 | R2250002C | Confezione 2 viti 4x40 + 2 tasselli + 1 chiave - 2 screws 4x40 + 2 raw plug + Allan key set | 6,00 |
| | R20528084 | Kit piastrina + grano serie Skuara - Plate + screw kit Skuara | 8,00 |
| | 5278.81 | Mensola vetro temperato spessore 8 mm - Glass shelf thickness 8 mm | 46,00 |
| 52843 | R2250002C | Confezione 2 viti 4x40 + 2 tasselli + 1 chiave - 2 screws 4x40 + 2 raw plug + Allan key set | 6,00 |
| | R20528084 | Kit piastrina + grano serie Skuara - Plate + screw kit Skuara | 8,00 |
| 52844 | R2250002C | Confezione 2 viti 4x40 + 2 tasselli + 1 chiave - 2 screws 4x40 + 2 raw plug + Allan key set | 6,00 |
| | R20528084 | Kit piastrina + grano serie Skuara - Plate + screw kit Skuara | 8,00 |
| 52801.29 | R2252801 | Guarnizione - Gasket | 6,00 |
| | R23528011 | Vaschetta inox - Inox container | 16,00 |
| 52804.09 | R2553951 | Pompetta completa in ottone cromato per dosatore in vetro e porcellana - Brass chromed pump for glass and porcelaine soap dispenser. | 24,00 |
| | R21528041 | Spandisapone ceramica, 300 ml - Soap dispenser ceramic, 300 ml | 46,00 |
| | R2244006 | Tappo filettato per dosatore - Threaded cap for dispenser | 4,00 |
| | R22440021 | Tubetto in plastica per pompetta - Plastic tube for pump | 5,00 |
| | R2244002 | Tubetto per pompetta - Plastic tube for pump | 5,00 |
| 52804.29 | R2344090 | Pompetta per dosatore inox - Pump for soap dispenser in stainless steel | 23,00 |
| | R22440021 | Tubetto in plastica per pompetta - Plastic tube for pump | 5,00 |
| | R2252801 | Guarnizione - Gasket | 6,00 |
| | R2244002 | Tubetto per pompetta - Plastic tube for pump | 5,00 |
| | R23528011 | Vaschetta inox - Inox container | 16,00 |
| 61223.09 | R2553951 | Pompetta completa in ottone cromato per dosatore - Brass chromed pump for soap dispenser. | 24,00 |
| 61223.23 | R245395123 | Pompetta completa in ottone verniciato nero opaco per dosatore - Soap dispenser pump in painted matt black brass.. | 28,00 |

Ricambi _ Spare parts _ Pièces détachées _ Ersatzteile

| | | | |
|-----------------|-----------|---|-------|
| 52805.09 | R2250055 | Setola scopino - Toilet brush | 9,00 |
| | R539329 | Manico scopino cromato con ciuffo - Toilet brush with chromed stick | 25,00 |
| | R21528051 | Porta scopino - Toilet brush holder | 37,00 |
| | R2250054 | Copriscopino Ø 67 - Toilet brush lid Ø 67 | 7,00 |
| | R2550069 | Manico scopino 300 mm - Toilet brush handle 300 mm | 19,00 |
| 52805.29 | R2250055 | Setola scopino - Toilet brush | 9,00 |
| | R23528051 | Porta scopino - Toilet brush holder | 34,00 |
| | R539329 | Manico scopino cromato con ciuffo - Toilet brush with chromed stick | 25,00 |
| | R2250056 | Copri scopino - Toilet brush lid | 7,00 |
| | R2550069 | Manico scopino 300 mm - Toilet brush handle 300 mm | 19,00 |
| | R23528052 | Vaschetta inox - Inox container | 20,00 |
| | R2252805 | Guarnizione scopino d. 73 - 80 mm Toilet brush seal diam. 73-80 mm | 6,00 |
| 5204 | R2250002C | Confezione 2 viti 4x40 + 2 tasselli + 1 chiave - 2 screws 4x40 + 2 raw plug + Allan key set | 6,00 |
| | R2500119 | Piastrina conica Ø 30 mm - Conical plate Ø 30 mm | 6,00 |
| | R25001191 | kit piastrina + grano serie baketo - plate kit + grain baketo series | 7,00 |
| 5203 | R2250002 | Confezione 2 viti 4x40 + 2 tasselli - 2 screws 4x40 + 2 raw plug set | 5,00 |
| 5205 | R2250002C | Confezione 2 viti 4x40 + 2 tasselli + 1 chiave - 2 screws 4x40 + 2 raw plug + Allan key set | 6,00 |
| | R2500119 | Piastrina conica Ø 30 mm - Conical plate Ø 30 mm | 6,00 |
| | R25001191 | kit piastrina + grano serie baketo - plate kit + grain baketo series | 7,00 |
| 5208 | R2250004C | Confezione 4 viti 4x40 + 4 tasselli +1 chiave - 4 screws 4x40 + 4 raw plug + Allan key set | 6,00 |
| | R2500119 | Piastrina conica Ø 30 mm - Conical plate Ø 30 mm | 6,00 |
| | R25001191 | kit piastrina + grano serie baketo | 7,00 |
| 5210 | R2250004C | Confezione 4 viti 4x40 + 4 tasselli +1 chiave - 4 screws 4x40 + 4 raw plug + Allan key set | 6,00 |
| | R2500119 | Piastrina conica Ø 30 mm - Conical plate Ø 30 mm | 6,00 |
| | R25001191 | kit piastrina + grano serie baketo - plate kit + grain baketo series | 7,00 |
| 5211 | R2250004C | Confezione 4 viti 4x40 + 4 tasselli +1 chiave - 4 screws 4x40 + 4 raw plug + Allan key set | 6,00 |
| | R25001191 | kit piastrina + grano serie baketo - plate kit + grain baketo series | 7,00 |
| | R2500119 | Piastrina conica Ø 30 mm - Conical plate Ø 30 mm | 6,00 |
| 5212 | R2250004C | Confezione 4 viti 4x40 + 4 tasselli +1 chiave - 4 screws 4x40 + 4 raw plug + Allan key set | 6,00 |
| | R25001191 | kit piastrina + grano serie baketo - plate kit + grain baketo series | 7,00 |
| | R2500119 | Piastrina conica Ø 30 mm - Conical plate Ø 30 mm | 6,00 |
| 5214 | R2250004C | Confezione 4 viti 4x40 + 4 tasselli +1 chiave - 4 screws 4x40 + 4 raw plug + Allan key set | 6,00 |
| | R25001191 | kit piastrina + grano serie baketo - plate kit + grain baketo series | 7,00 |
| | R2500119 | Piastrina conica Ø 30 mm - Conical plate Ø 30 mm | 6,00 |

Spare parts _ Pièces détachées _ Ersatzteile _ **Ricambi**

| | | | |
|--------------|-----------|--|-------|
| 52152 | R2250004C | Confezione 4 viti 4x40 + 4 tasselli +1 chiave - 4 screws 4x40 + 4 raw plug + Allan key set | 6,00 |
| | R25001191 | kit piastrina + grano serie baketo - plate kit + grain baketo series | 7,00 |
| | R2500119 | Piastrina conica Ø 30 mm - Conical plate Ø 30 mm | 6,00 |
| 52153 | R2250004C | Confezione 4 viti 4x40 + 4 tasselli +1 chiave - 4 screws 4x40 + 4 raw plug + Allan key set | 6,00 |
| | R25001191 | kit piastrina + grano serie baketo - plate kit + grain baketo series | 7,00 |
| | R2500119 | Piastrina conica Ø 30 mm - Conical plate Ø 30 mm | 6,00 |
| | R2255173 | Guarnizione in plastica - Plastic gasket | 6,00 |
| 52011 | R2255011 | Guarnizione silicone Ø 70 mm - Silicon gasket Ø 70 mm | 6,00 |
| | R2250002C | Confezione 2 viti 4x40 + 2 tasselli + 1 chiave - 2 screws 4x40 + 2 raw plug + Allan key set | 6,00 |
| | R25001191 | kit piastrina + grano serie baketo - plate kit + grain baketo series | 7,00 |
| | R2500119 | Piastrina conica Ø 30 mm - Conical plate Ø 30 mm | 6,00 |
| 52061 | R2255011 | Guarnizione silicone Ø 70 mm - Silicon gasket Ø 70 mm | 6,00 |
| | R2250002C | Confezione 2 viti 4x40 + 2 tasselli + 1 chiave - 2 screws 4x40 + 2 raw plug + Allan key set | 6,00 |
| | R25001191 | kit piastrina + grano serie baketo - plate kit + grain baketo series | 7,00 |
| | R2500119 | Piastrina conica Ø 30 mm - Conical plate Ø 30 mm | 6,00 |
| 5216 | R2250004C | Confezione 4 viti 4x40 + 4 tasselli +1 chiave - 4 screws 4x40 + 4 raw plug + Allan key set | 6,00 |
| | R25001191 | kit piastrina + grano serie baketo - plate kit + grain baketo series | 7,00 |
| | R2500119 | Piastrina conica Ø 30 mm - Conical plate Ø 30 mm | 6,00 |
| 5234 | R2250004C | Confezione 4 viti 4x40 + 4 tasselli +1 chiave - 4 screws 4x40 + 4 raw plug + Allan key set | 6,00 |
| | R25001191 | kit piastrina + grano serie baketo - plate kit + grain baketo series | 7,00 |
| | R2500119 | Piastrina conica Ø 30 mm - Conical plate Ø 30 mm | 6,00 |
| 5233 | R2250004C | Confezione 4 viti 4x40 + 4 tasselli +1 chiave - 4 screws 4x40 + 4 raw plug + Allan key set | 6,00 |
| | R25001191 | kit piastrina + grano serie baketo - plate kit + grain baketo series | 7,00 |
| | R2500119 | Piastrina conica Ø 30 mm - Conical plate Ø 30 mm | 6,00 |
| 5217 | R2553951 | Pompetta completa in ottone cromato per dosatore in vetro e porcellana - Brass chromed pump for glass and porcelaine soap dispenser, | 24,00 |
| | R2240402 | Flacone in plastica, 180 ml - Plastic dispenser, 180 ml | 7,00 |
| | R2250002C | Confezione 2 viti 4x40 + 2 tasselli + 1 chiave - 2 screws 4x40 + 2 raw plug + Allan key set | 6,00 |
| | R2500119 | Piastrina conica Ø 30 mm - Conical plate Ø 30 mm | 6,00 |
| | R2200108 | O-ring - O-ring | 6,00 |
| | R2244002 | Tubetto per pompetta - Plastic tube for pump | 5,00 |
| | R22440021 | Tubetto in plastica per pompetta - Plastic tube for pump | 5,00 |

Ricambi _ Spare parts _ Pièces détachées _ Ersatzteile

| | | | |
|--------------|-----------|--|-------|
| 5504 | R2250002C | Confezione 2 viti 4x40, 2 tasselli , 1 chiave - 2 screws 4x40, 2 raw plug, Allan key set | 6,00 |
| | R25001181 | Kit piastrina + grano - Plate + screw kit | 6,00 |
| 5508 | R2250002C | Confezione 2 viti 4x40, 2 tasselli , 1 chiave - 2 screws 4x40, 2 raw plug, Allan key set | 6,00 |
| | R25001181 | Kit piastrina + grano - Plate + screw kit | 6,00 |
| 5505 | R2250002C | Confezione 2 viti 4x40, 2 tasselli , 1 chiave - 2 screws 4x40, 2 raw plug, Allan key set | 6,00 |
| | R25001181 | Kit piastrina + grano - Plate + screw kit | 6,00 |
| 5507 | R2250004C | Confezione 4 viti 4x4, 4 tasselli, chiave -4 screws 4x40, 4 raw plug, Allan key set | 6,00 |
| | R25001181 | Kit piastrina + grano - Plate + screw kit | 6,00 |
| 5509 | R2250002C | Confezione 2 viti 4x40, 2 tasselli , 1 chiave - 2 screws 4x40, 2 raw plug, Allan key set | 6,00 |
| | R25001181 | Kit piastrina + grano - Plate + screw kit | 6,00 |
| 5511 | R2250002C | Confezione 2 viti 4x40, 2 tasselli , 1 chiave - 2 screws 4x40, 2 raw plug, Allan key set | 6,00 |
| | R25001181 | Kit piastrina + grano - Plate + screw kit | 6,00 |
| 5512 | R2250004C | Confezione 4 viti 4x4, 4 tasselli, chiave -4 screws 4x40, 4 raw plug, Allan key set | 6,00 |
| | R25001181 | Kit piastrina + grano - Plate + screw kit | 6,00 |
| 5513 | R2250004C | Confezione 4 viti 4x4, 4 tasselli, chiave -4 screws 4x40, 4 raw plug, Allan key set | 6,00 |
| | R25001181 | Kit piastrina + grano - Plate + screw kit | 6,00 |
| 5514 | R2250004C | Confezione 4 viti 4x4, 4 tasselli, chiave -4 screws 4x40, 4 raw plug, Allan key set | 6,00 |
| | R25001181 | Kit piastrina + grano - Plate + screw kit | 6,00 |
| 5517 | R2250004C | Confezione 4 viti 4x4, 4 tasselli, chiave -4 screws 4x40, 4 raw plug, Allan key set | 6,00 |
| | R25001181 | Kit piastrina + grano - Plate + screw kit | 6,00 |
| 55001 | R2255011 | Guarnizione silicone Ø 70 mm - Silicon gasket Ø 70 mm | 6,00 |
| | R2250002C | Confezione 2 viti 4x40, 2 tasselli , 1 chiave - 2 screws 4x40, 2 raw plug, Allan key set | 6,00 |
| | R25001181 | Kit piastrina + grano - Plate + screw kit | 6,00 |
| 55002 | R2255011 | Guarnizione silicone Ø 70 mm - Silicon gasket Ø 70 mm | 6,00 |
| | R2250002C | Confezione 2 viti 4x40, 2 tasselli , 1 chiave - 2 screws 4x40, 2 raw plug, Allan key set | 6,00 |
| | R25001181 | Kit piastrina + grano - Plate + screw kit | 6,00 |
| 55061 | R2255011 | Guarnizione silicone Ø 70 mm - Silicon gasket Ø 70 mm | 6,00 |
| | R2250002C | Confezione 2 viti 4x40, 2 tasselli , 1 chiave - 2 screws 4x40, 2 raw plug, Allan key set | 6,00 |
| | R25001181 | Kit piastrina + grano - Plate + screw kit | 6,00 |
| 5526 | R2250004C | Confezione 4 viti 4x4, 4 tasselli, chiave -4 screws 4x40, 4 raw plug, Allan key set | 6,00 |
| | R25001181 | Kit piastrina + grano - Plate + screw kit | 6,00 |
| 55032 | R22440021 | Tubetto in plastica per pompetta - Plastic tube for pump - | 5,00 |
| | R2553951 | Pompetta completa in ottone cromato per dosatore in vetro e porcellana, Brass chromed pump for glass and porcelaine soap dispenser | 24,00 |
| | R2250004C | Confezione 4 viti 4x4, 4 tasselli, chiave -4 screws 4x40, 4 raw plug, Allan key set | 6,00 |
| | R25001181 | Kit piastrina + grano - Plate + screw kit | 6,00 |
| | R2200108 | O-ring - O-ring | 6,00 |
| | R2240403 | Flacone in plastica, 220 ml - Plastic dispenser, 220 ml | 7,00 |
| | R2244002 | Tubetto per pompetta - Plastic tube for pump | 5,00 |

Spare parts _ Pièces détachées _ Ersatzteile _ **Ricambi**

| | | | |
|--------------|-----------|---|-------|
| 55062 | R2155062 | Vaso porta scopino in porcellana - Porcelaine toilet brush holder | 26,00 |
| | R2652061 | Vaso vetro acidato per porta scopino - Etched glass toilet brush | 20,00 |
| | R2250055 | Setola scopino - Toilet brush | 9,00 |
| | R539329 | Manico scopino cromato con ciuffo - Toilet brush with chromed stick | 25,00 |
| | R2250054 | Copriscopino Ø 67 - Toilet brush lid Ø 67 | 7,00 |
| | R2550069 | Manico scopino 300 mm - Toilet brush handle 300 mm | 19,00 |
| 5254 | R2250001C | Confezione 1 vite 4x40 + 1 tassello + 1 chiave - 1 screws 4x40 + 1 raw plug + Allan key set | 6,00 |
| | R2552532 | Kit perno + grano serie Picola - Plate + screw kit Picola | 10,00 |
| 52535 | R2250001C | Confezione 1 vite 4x40 + 1 tassello + 1 chiave - 1 screws 4x40 + 1 raw plug + Allan key set | 6,00 |
| | R2552532 | Kit perno + grano serie Picola - Plate + screw kit Picola | 10,00 |
| 5255 | R2250002C | Confezione 2 viti 4x40 + 2 tasselli + 1 chiave - 2 screws 4x40 + 2 raw plug + Allan key set | 6,00 |
| | R2552532 | Kit perno + grano serie Picola - Plate + screw kit Picola | 10,00 |
| 5258 | R2250002C | Confezione 2 viti 4x40 + 2 tasselli + 1 chiave - 2 screws 4x40 + 2 raw plug + Allan key set | 6,00 |
| | R2552532 | Kit perno + grano serie Picola - Plate + screw kit Picola | 10,00 |
| 5259 | R2250001C | Confezione 1 vite 4x40 + 1 tassello + 1 chiave - 1 screws 4x40 + 1 raw plug + Allan key set | 6,00 |
| | R2552532 | Kit perno + grano serie Picola - Plate + screw kit Picola | 10,00 |
| 5260 | R2250002C | Confezione 2 viti 4x40 + 2 tasselli + 1 chiave - 2 screws 4x40 + 2 raw plug + Allan key set | 6,00 |
| | R2552532 | Kit perno + grano serie Picola - Plate + screw kit Picola | 10,00 |
| 5262 | R2250002C | Confezione 2 viti 4x40 + 2 tasselli + 1 chiave - 2 screws 4x40 + 2 raw plug + Allan key set | 6,00 |
| | R2552532 | Kit perno + grano serie Picola - Plate + screw kit Picola | 10,00 |
| 5264 | R2250002C | Confezione 2 viti 4x40 + 2 tasselli + 1 chiave - 2 screws 4x40 + 2 raw plug + Allan key set | 6,00 |
| | R2552532 | Kit perno + grano serie Picola - Plate + screw kit Picola | 10,00 |

Ricambi _ Spare parts _ Pièces détachées _ Ersatzteile

| | | | |
|--------------|-----------|---|-------|
| 5265 | R2250002C | Confezione 2 viti 4x40 + 2 tasselli + 1 chiave - 2 screws 4x40 + 2 raw plug + Allan key set | 6,00 |
| | R2552532 | Kit perno + grano serie Picola - Plate + screw kit Picola | 10,00 |
| 52511 | R2255011 | Guarnizione silicone Ø 70 mm - Silicon gasket Ø 70 mm | 6,00 |
| | R2250001C | Confezione 1 vite 4x40 + 1 tassello + 1 chiave - 1 screws 4x40 + 1 raw plug + Allan key set | 6,00 |
| | R2552532 | Kit perno + grano serie Picola - Plate + screw kit Picola | 10,00 |
| 52561 | R2255061 | Guarnizione in silicone Ø 90 mm - Silicon gasket Ø 90 mm | 6,00 |
| | R2250001C | Confezione 1 vite 4x40 + 1 tassello + 1 chiave - 1 screws 4x40 + 1 raw plug + Allan key set | 6,00 |
| | R2552532 | Kit perno + grano serie Picola - Plate + screw kit Picola | 10,00 |
| 5273 | R2250002C | Confezione 2 viti 4x40 + 2 tasselli + 1 chiave - 2 screws 4x40 + 2 raw plug + Allan key set | 6,00 |
| | R2552532 | Kit perno + grano serie Picola - Plate + screw kit Picola | 10,00 |
| 55006 | R2553951 | Pompetta completa in ottone cromato per dosatore in vetro e porcellana - Brass chromed pump for glass and porcelaine soap dispenser | 24,00 |
| | R2652031 | Vaso vetro acidato per dosatore, 200 ml - Etched glass soap dispenser, 200 ml | 19,00 |
| | R2652032 | Vaso porcellana per dosasapone, 200 ml - Porcelaine soap dispenser holder, 200 ml | 19,00 |
| | R2244002 | Tubetto per pompetta - Plastic tube for pump | 5,00 |
| | R2255006 | Guarnizione in plastica - Plastic gasket | 8,00 |
| | R25550061 | Ghiera in ottone con guarnizione in plastica - Chromed brass ring with plastic gasket | 13,00 |
| 52901 | R2152901 | Bicchieri - Tumbler | 20,00 |
| | R2250002C | Confezione 2 viti 4x40 + 2 tasselli + 1 chiave - 2 screws 4x40 + 2 raw plug + Allan key set | 6,00 |
| | R2500118 | Kit piastrina conica + grano Ø 38 mm - Conical plate and screw kit Ø 38 mm | 6,00 |
| 52902 | R2152902 | Portasapone - Soap dish | 32,00 |
| | R2250002C | Confezione 2 viti 4x40 + 2 tasselli + 1 chiave - 2 screws 4x40 + 2 raw plug + Allan key set | 6,00 |
| | R2500118 | Kit piastrina conica + grano Ø 38 mm - Conical plate and screw kit Ø 38 mm | 6,00 |
| 52926 | R2250004C | Confezione 4 viti 4x4, 4 tasselli, chiave -4 screws 4x40, 4 raw plug, Allan key set | 6,00 |
| | R2500118 | Kit piastrina conica + grano Ø 38 mm - Conical plate and screw kit Ø 38 mm | 6,00 |
| 52908 | R2250002C | Confezione 2 viti 4x40 + 2 tasselli + 1 chiave - 2 screws 4x40 + 2 raw plug + Allan key set | 6,00 |
| | R2500118 | Kit piastrina conica + grano Ø 38 mm - Conical plate and screw kit Ø 38 mm | 6,00 |
| 52907 | R2250002C | Confezione 2 viti 4x40 + 2 tasselli + 1 chiave - 2 screws 4x40 + 2 raw plug + Allan key set | 6,00 |
| | R2500118 | Kit piastrina conica + grano Ø 38 mm - Conical plate and screw kit Ø 38 mm | 6,00 |
| 52910 | R2250002C | Confezione 2 viti 4x40 + 2 tasselli + 1 chiave - 2 screws 4x40 + 2 raw plug + Allan key set | 6,00 |
| | R2500118 | Kit piastrina conica + grano Ø 38 mm - Conical plate and screw kit Ø 38 mm | 6,00 |
| 52938 | R2250002C | Confezione 2 viti 4x40 + 2 tasselli + 1 chiave - 2 screws 4x40 + 2 raw plug + Allan key set | 6,00 |
| | R2500118 | Kit piastrina conica + grano Ø 38 mm - Conical plate and screw kit Ø 38 mm | 6,00 |
| 52939 | R2250002C | Confezione 2 viti 4x40 + 2 tasselli + 1 chiave - 2 screws 4x40 + 2 raw plug + Allan key set | 6,00 |
| | R2500118 | Kit piastrina conica + grano Ø 38 mm - Conical plate and screw kit Ø 38 mm | 6,00 |

Spare parts _ Pièces détachées _ Ersatzteile _ **Ricambi**

| | | | |
|--------------|-----------|---|-------|
| 52921 | R2250002C | Confezione 2 viti 4x40 + 2 tasselli + 1 chiave - 2 screws 4x40 + 2 raw plug + Allan key set | 6,00 |
| | R2500118 | Kit piastrina conica + grano Ø 38 mm - Conical plate and screw kit Ø 38 mm | 6,00 |
| 52914 | R2250004C | Confezione 4 viti 4x4, 4 tasselli, chiave -4 screws 4x40, 4 raw plug, Allan key set | 6,00 |
| | R2500118 | Kit piastrina conica + grano Ø 38 mm - Conical plate and screw kit Ø 38 mm | 6,00 |
| 52916 | R2250004C | Confezione 4 viti 4x4, 4 tasselli, chiave -4 screws 4x40, 4 raw plug, Allan key set | 6,00 |
| | R2500118 | Kit piastrina conica + grano Ø 38 mm - Conical plate and screw kit Ø 38 mm | 6,00 |
| 52917 | R2250004C | Confezione 4 viti 4x4, 4 tasselli, chiave -4 screws 4x40, 4 raw plug, Allan key set | 6,00 |
| | R2500118 | Kit piastrina conica + grano Ø 38 mm - Conical plate and screw kit Ø 38 mm | 6,00 |
| 52920 | R2250004C | Confezione 4 viti 4x4, 4 tasselli, chiave -4 screws 4x40, 4 raw plug, Allan key set | 6,00 |
| | R2500118 | Kit piastrina conica + grano Ø 38 mm - Conical plate and screw kit Ø 38 mm | 6,00 |
| 52932 | R2250004C | Confezione 4 viti 4x4, 4 tasselli, chiave -4 screws 4x40, 4 raw plug, Allan key set | 6,00 |
| | R2500118 | Kit piastrina conica + grano Ø 38 mm - Conical plate and screw kit Ø 38 mm | 6,00 |
| 52906 | R2152906 | Portascopino - Towel brush | 25,00 |
| | R2250056 | Copriscopino - Toilet brush | 7,00 |
| | R2250055 | Setola scopino - Toilet brush | 9,00 |
| | R2250002C | Confezione 2 viti 4x40 + 2 tasselli + 1 chiave - 2 screws 4x40 + 2 raw plug + Allan key set | 6,00 |
| | R2500118 | Kit piastrina conica + grano Ø 38 mm - Conical plate and screw kit Ø 38 mm | 6,00 |
| | R25529061 | Manico scopino cromato - Toilet brush chrome | 29,00 |
| 61101 | R2661101 | Bicchieri in vetro satinato - Satin glass tumbler | 34,00 |
| 61102 | R2661102 | Piattino in vetro satinato - Satin glass soap dish | 27,00 |
| 61103 | R2661103 | Bottiglia dosatore 250 ml in vetro satinato - Satin glass bottle 250 ml | 32,00 |
| | R25611032 | Pompetta completa in ABS cromato - ABS chromed pump | 33,00 |
| | R25611033 | Pompetta completa in ABS verniciato nero - ABS black painted pump | 53,00 |

SAON

accessori appoggio _ Tabletop accessories _ Accessoires à poser _ Stand Accessoires



SAON: per noi veneti è il sapone, sia liquido che solido.

Una collezione completa di oggettistica da appoggio, dalle forme semplici e rigorose, realizzati nei materiali più vari.
Designers: Opendesignitalia _ Spiral product design _ London _ Mimmo Lorella

EN

SAON: for Venetians it is soap, both liquid and solid.

A complete collection of free-standing objects, characterised by simple and rigorous shapes, made using a large variety of materials.

Designers: OpenDesignItalia - Spiral Product Design - London - Mimmo Lorella

Glazed porcelain, polished steel, painted aluminium, hand-blown borosilicate glass

FR

SAON : pour nous vénitiens, c'est le savon, aussi bien liquide que solide.

Une collection complète d'objets à poser, aux formes simples et précises, réalisés dans différents matériaux.

Designers : OpenDesignItalia - Spiral Product Design - Londres - Mimmo Lorella

Porcelaine émaillée, acier brillant, aluminium verni, verre borosilicate soufflé bouche

DE

SAON: für uns aus Venetien die Seife, ob flüssig oder fest.

Eine vollständige Kollektion von Ablagen mit schlichten, strengen Formen, die in den verschiedensten Materialien hergestellt werden.

Designer: OpenDesignItalia - Spiral Product Design - London - Mimmo Lorella

Emailliertes Porzellan, glänzender Stahl, lackiertes Aluminium, handgeblasenes Boro-silikatglas

Porcellana

Porcelaine
Porcelaine
Porzellan



.09

Vetro acidato

Etched glass
Verre dépoli
Geätztes Glas

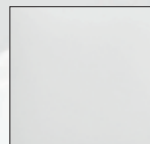

.81

Acciaio inox lucido

Polished stainless steel
Acier inoxydable brillant
Poliert Edelstahl



.29

Ottone cromato

Chromed brass
Laiton chromé
Verchromtes Messing



.29

Verniciato nero opaco

Painted matt black
Laqué noir mat
Lackiert Matt Schwarz

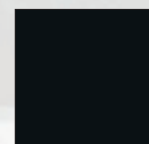

.23

Silicone bianco

White silicon
Silicone blanc
Silikon Weiß



.09

Silicone arancio

Orange silicon
Silicone orange
Silikon Orange



.15

Silicone magenta

Magenta silicon
Silicone magenta
Silikon Magenta

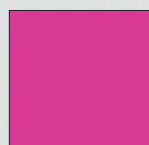

.16

Silicone antracite

Anthracite silicon
Silicone anthracite
Silikon Anthrazit

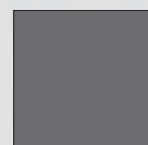

.17



SAON

Bicchieri

Tumbler / Verre / Becher

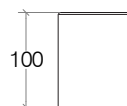

Porcellana
Porcelaine
Porcelaine
Porzellan



44021

.09

€

24,00

Portasapone

Soap dish / Porte-savon / Seifenschale

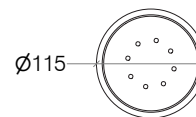

Porcellana
Porcelaine
Porcelaine
Porzellan



44022

.09

€

37,00

Dosapone 500 ml

Soap dispenser 500 ml / Distributeur savon liquide 500 ml / Seifenspender 500 ml

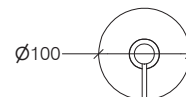
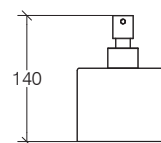

Porcellana
Porcelaine
Porcelaine
Porzellan



44023

.09

.23

€

61,00

61,00

Dosasapone 400 ml

Soap dispenser 400 ml / Distributeur savon liquide 400 ml / Seifenspender 400 ml

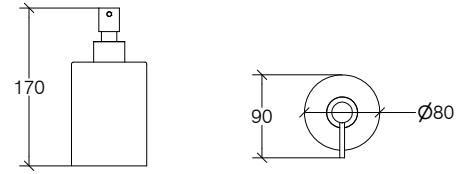

Porcellana
Porcelaine
Porcelaine
Porzellan



| | | |
|--------------|------------|------------|
| 44024 | .09 | .23 |
| € | 61,00 | 61,00 |

Tazza portaspazzolini

Toothbrush holder mug / Porte-brosses à dents / Zahnbürstehalter

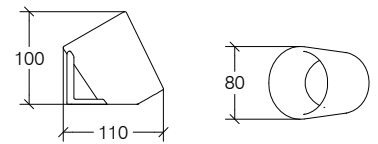

Porcellana
Porcelaine
Porcelaine
Porzellan



| | |
|--------------|------------|
| 44025 | .09 |
| € | 41,00 |



Bicchiere

Tumbler / Verre / Becher

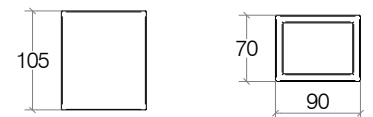

Porcellana
Porcelaine
Porcelaine
Porzellan



| | |
|--------------|------------|
| 44031 | .09 |
| € | 48,00 |

SAON

Portasapone

Soap dish / Porte-savon / Seifenschale

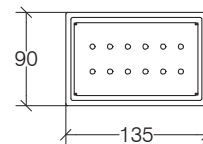
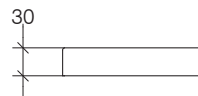

Porcellana
Porcelaine
Porcelaine
Porzellan



44032

.09

€

50,00

Dosasapone 400 ml

Soap dispenser 400 ml / Distributeur savon liquide 400 ml / Seifenspender 400 ml

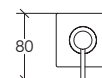
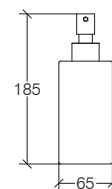

Porcellana
Porcelaine
Porcelaine
Porzellan



44033

.09

.23

€

70,00

70,00

Dosasapone 600 ml

Soap dispenser 600 ml / Distributeur savon liquide 600 ml / Seifenspender 600 ml

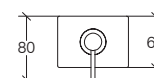
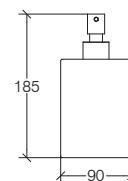

Porcellana
Porcelaine
Porcelaine
Porzellan



44034

.09

.23

€

73,00

73,00

Dosasapone 500 ml

Soap dispenser 500 ml / Distributeur savon liquide 500 ml / Seifenspender 500 ml

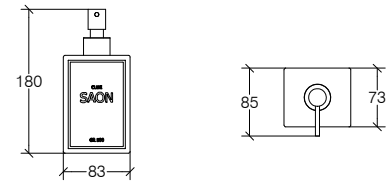

Porcellana
Porcelaine
Porcelaine
Porzellan



| | | |
|--------------|------------|------------|
| 44041 | .09 | .23 |
| € | 73,00 | 73,00 |



Dosasapone 250 m

Soap dispenser 250 ml / Distributeur savon liquide 250 ml / Seifenspender 250 ml

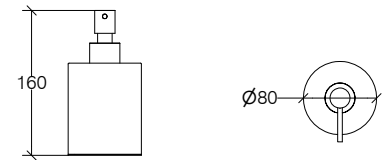

Alluminio verniciato
Painted aluminium
Aluminium laqué
Lackiertem Aluminium

Alluminio verniciato
Painted aluminium
Aluminium laqué
Lackiertem Aluminium

Acciaio inox lucido
Polished stainless steel
Acier inoxydable brillant
Poliert Edelstahl



| | | | |
|--------------|------------|------------|------------|
| 44018 | .09 | .23 | .29 |
| € | 52,00 | 52,00 | 80,00 |



Dosasapone 220 ml

Soap dispenser 220 ml / Distributeur savon liquide 220 ml / Seifenspender 220 ml

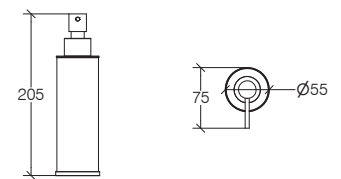

Ottone cromato
Chromed brass
Laiton chromé
Verchromtes Messing

Ottone verniciato
Painted brass
Laiton laqué
Lackiertem Messing



| | | |
|-------------|------------|------------|
| 4400 | .29 | .23 |
| € | 66,00 | 66,00 |



SAON

Bicchieri

Tumbler / Verre / Becher

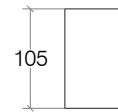

Acciaio inox lucido
Polished stainless steel
Acier inoxydable brillant
Poliert Edelstahl



| | |
|-------------|------------|
| 4412 | .29 |
| € | 36,00 |

Portasapone

Soap dish / Porte-savon / Seifenschale

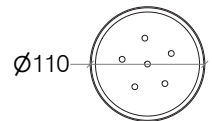

Acciaio inox lucido
Polished stainless steel
Acier inoxydable brillant
Poliert Edelstahl



| | |
|-------------|------------|
| 4413 | .29 |
| € | 40,00 |

Bicchieri

Tumbler / Verre / Becher

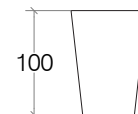

Acciaio inox lucido
Polished stainless steel
Acier inoxydable brillant
Poliert Edelstahl



| | |
|-------------|------------|
| 4414 | .29 |
| € | 34,00 |

Dosapone 350 ml

Soap dispenser 350 ml / Distributeur savon liquide 350 ml / Seifenspender 350 ml

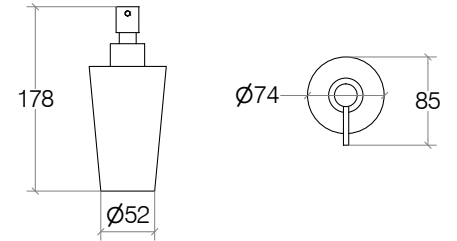

Acciaio inox lucido
Polished stainless steel
Acier inoxydable brillant
Poliert Edelstahl



| | |
|---------------|--------------|
| 528041 | .29 |
| € | 71,00 |

Bicchieri

Tumbler / Verre / Becher

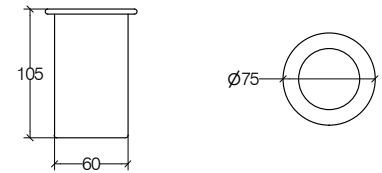

Porcellana
Porcelaine
Porcelaine
Porzellan

Vetro acidato
Etched glass
Verre dépoli
Geätztes Glas



| | | |
|--------------|--------------|--------------|
| 55003 | .09 | .81 |
| € | 20,00 | 20,00 |

Portasapone

Soap dish / Porte-savon / Seifenschale

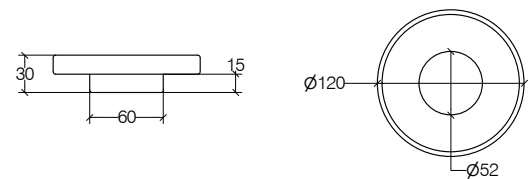

Porcellana
Porcelaine
Porcelaine
Porzellan

Vetro acidato
Etched glass
Verre dépoli
Geätztes Glas



| | | |
|--------------|--------------|--------------|
| 55004 | .09 | .81 |
| € | 20,00 | 20,00 |

SAON

Dosasapone 200 ml

Soap dispenser 200 ml / Distributeur savon liquide 200 ml / Seifenspender 200 ml

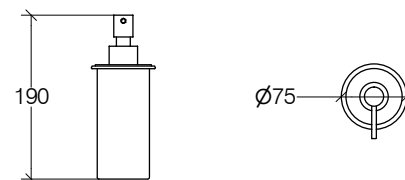

| 55006 | .09 | .09.23 | .81 | .81.23 |
|-------|-------|--------|-------|--------|
| € | 50,00 | 50,00 | 50,00 | 50,00 |

Ottone cromato
Chromed brass
Laiton chromé
Verchromtes Messing

Ottone verniciato
Painted brass
Laiton laqué
Lackiertem Messing

Porcellana
Porcelaine
Porzellan

Vetro acidato
Etched glass
Verre dépoli
Geätztes Glas

Griglietta in silicone antiscivolo per Art. 55004 (20 pezzi assortiti in 4 colori)

20 grip grids for soap dish 55004 / Grille en silicone 20 picks pour porte-savon 55004 / 20 Einlagen für Seifenschale 55004

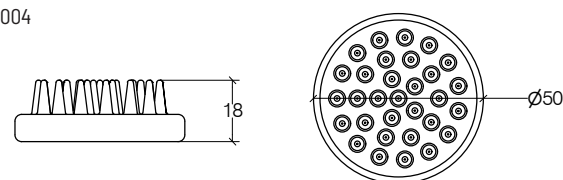

| 5200 | .09 | .15 | .16 | .17 |
|------|-------|-----|-----|-----|
| € | 48,00 | | | |

Silicone
Silicon
Silicone
Silikon

Bianco
White
Blanc
Weiß

Arancio
Orange
Orange
Orange

Magenta
Magenta
Magenta
Magenta

Antracite
Anthracite
Anthracite
Anthrazit

Portasapone

Soap dish / Porte-savon / Seifenschale

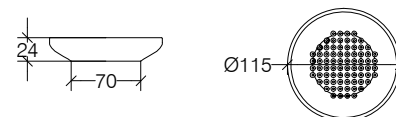

| 3901 | .09 | .15 | .16 | .17 |
|------|-------|-------|-------|-------|
| € | 17,00 | 17,00 | 17,00 | 17,00 |

Silicone
Silicon
Silicone
Silikon

Bianco
White
Blanc
Weiß

Arancio
Orange
Orange
Orange

Magenta
Magenta
Magenta
Magenta

Antracite
Anthracite
Anthracite
Anthrazit

Portasapone

Soap dish / Porte-savon / Seifenschale

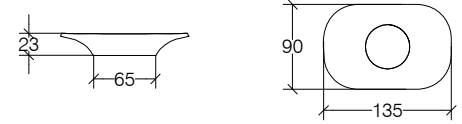

Silicone
Silicon
Silicone
Siiikon

Arancio
Orange
Orange
Orange

Magenta
Magenta
Magenta
Magenta

Antracite
Anthracite
Anthracite
Anthrazit



| | | | |
|-------------|------------|------------|------------|
| 3902 | .15 | .16 | .17 |
| € | 15,00 | 15,00 | 15,00 |

Bicchieri

Tumbler / Verre / Becher

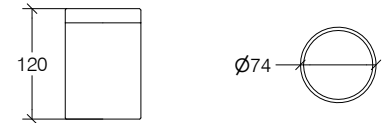

Silicone
Silicon
Silicone
Siiikon

Arancio
Orange
Orange
Orange

Magenta
Magenta
Magenta
Magenta

Antracite
Anthracite
Anthracite
Anthrazit



| | | | |
|-------------|------------|------------|------------|
| 3903 | .15 | .16 | .17 |
| € | 20,00 | 20,00 | 20,00 |

Dosapapone 200 ml

Soap dispenser 200 ml / Distributeur savon liquide 200 ml / Seifenspender 200 ml

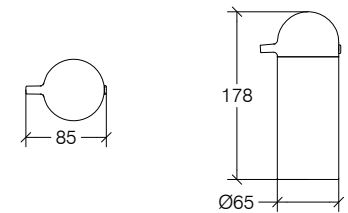

Silicone
Silicon
Silicone
Siiikon

Arancio
Orange
Orange
Orange

Magenta
Magenta
Magenta
Magenta

Antracite
Anthracite
Anthracite
Anthrazit



| | | | |
|-------------|------------|------------|------------|
| 3905 | .15 | .16 | .17 |
| € | 20,00 | 20,00 | 20,00 |

SAON

Ghiera per accessori da appoggio

Tabletop ring accessories / Anneau d'appui pour accessoires / Ring für Accessories

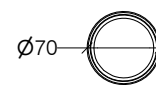
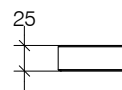

Ottone cromato
Chromed brass
Laiton chromé
Verchromtes Messing



44070

.29

€

16,00

Bicchieri

Tumbler / Verre / Becher

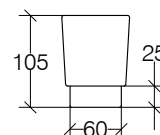

Porcellana
Porcelaine
Porcelaine
Porzellan



Acciaio inox lucido
Polished stainless steel
Acier inoxydable brillant
Poliert Edelstahl



Vetro acidato
Etched glass
Verre dépoli
Geätztes Glas



53020

.09

.29

.81

€

26,00

48,00

19,00

Portasapone

Soap dish / Porte-savon / Seifenschale

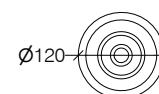
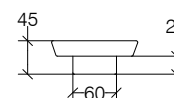

Porcellana
Porcelaine
Porcelaine
Porzellan



Acciaio inox lucido
Polished stainless steel
Acier inoxydable brillant
Poliert Edelstahl



Vetro acidato
Etched glass
Verre dépoli
Geätztes Glas



53021

.09

.29

.81

€

28,00

48,00

23,00

Dosapone 300 ml

Soap dispenser 300 ml / Distributeur savon liquide 300 ml / Seifenspender 300 ml

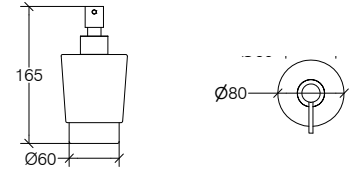

Porcellana
Porcelaine
Porcelaine
Porzellan

Acciaio inox lucido
Polished stainless steel
Acier inoxydable brillant
Poliert Edelstahl

Vetro acidato
Etched glass
Verre dépoli
Geätztes Glas



| | | | |
|--------------|------------|------------|------------|
| 53022 | .09 | .29 | .81 |
| € | 57,00 | 61,00 | 52,00 |

Ricambi _ Spare parts _ Pièces détachées _ Ersatzteile

| | | | |
|--------------|-----------|--|-------|
| 44022 | R2344022 | Griglia per art, 4422 - Grid for art, 4422 | 16,00 |
| 44023 | R2553951 | Pompetta completa in ottone cromato per dosasapone in vetro e porcellana Brass chromed pump for glass and porcelaine soap dispenser | 24,00 |
| | R22440021 | Tubetto in plastica per pompetta - Plastic tube for pump | 5,00 |
| | R2144023 | Spandisapone, 500 ml - Soap dispenser 500 ml | 30,00 |
| | R2244002 | Tubetto per pompetta - Plastic tube for pump | 5,00 |
| 44024 | R2553951 | Pompetta completa in ottone cromato per dosatore in vetro e porcellana Brass chromed pump for glass and porcelaine soap dispenser | 24,00 |
| | R22440021 | Tubetto in plastica per pompetta - Plastic tube for pump | 5,00 |
| | R2144024 | Spandisapone, 400 ml - Soap dispenser 400 ml | 29,00 |
| | R2244002 | Tubetto per pompetta - Plastic tube for pump | 5,00 |
| 44032 | R2344032 | Griglia per art, 44032 - Grid for art, 44032 | 23,00 |
| 44033 | R2553951 | Pompetta completa in ottone cromato per dosasapone in vetro e porcellana Brass chromed pump for glass and porcelaine soap dispenser | 24,00 |
| | R22440021 | Tubetto in plastica per pompetta - Plastic tube for pump | 5,00 |
| | R2144033 | Spandisapone, 400 ml - Soap dispenser 400 ml | 36,00 |
| | R2244002 | Tubetto per pompetta - Plastic tube for pump | 5,00 |
| 44034 | R2553951 | Pompetta completa in ottone cromato per dosasapone in vetro e porcellana Brass chromed pump for glass and porcelaine soap dispenser | 24,00 |
| | R22440021 | Tubetto in plastica per pompetta - Plastic tube for pump | 5,00 |
| | R2144034 | Spandisapone, 600 ml - Soap dispenser 600 ml | 44,00 |
| | R2244002 | Tubetto per pompetta - Plastic tube for pump | 5,00 |
| 44041 | R2553951 | Pompetta completa in ottone cromato per dosasapone in vetro e porcellana Brass chromed pump for glass and porcelaine soap dispenser | 24,00 |
| | R22440021 | Tubetto in plastica per pompetta - Plastic tube for pump | 5,00 |
| | R21440419 | Dosasapone - Soap dispenser | 48,00 |
| | R2244002 | Tubetto per pompetta - Plastic tube for pump | 5,00 |
| 4400 | R2553951 | Pompetta completa in ottone cromato per dosasapone in vetro e porcellana Brass chromed pump for glass and porcelaine soap dispenser | 24,00 |
| | R2240403 | Flacone in plastica, 220 ml - Plastic dispenser, 220 ml | 7,00 |
| | R22440021 | Tubetto in plastica per pompetta - Plastic tube for pump | 5,00 |
| | R2200108 | O-ring - O-ring | 6,00 |
| | R2244002 | Tubetto per pompetta - Plastic tube for pump | 5,00 |
| 4413 | R23441312 | Griglia - Grid | 23,00 |
| 44018 | R2553951 | Pompetta completa in ottone cromato per dosasapone in vetro e porcellana Brass chromed pump for glass and porcelaine soap dispenser | 24,00 |
| | R22440181 | Flacone plastica interno - Internal plastic container | 7,00 |
| | R2244002 | Tubetto per pompetta - Plastic tube for pump | 5,00 |

Spare parts _ Pièces détachées _ Ersatzteile _ **Ricambi**

| | | | |
|--------------------|--------------|--|--|
| 44070 | R2253011 | Guarnizione silicone Ø 70 mm - Silicon gasket Ø 70 mm | 6,00 |
| 55006 | R2553951 | Pompetta completa in ottone cromato per dosasapone in vetro e porcellana Brass chromed pump for glass and porcelaine soap dispenser | 24,00 |
| | R2652031 | Vaso vetro acidato per dosatore, 200 ml - Etched glass soap dispenser, 200 ml | 19,00 |
| | R2155006 | Vaso porcellana per dosasapone, 200 ml - Porcelaine soap dispenser holder, 200 ml | 19,00 |
| | R2244002 | Tubetto per pompetta - Plastic tube for pump | 5,00 |
| | R2255006 | Guarnizione in plastica - Plastic gasket | 8,00 |
| | R25550061 | Ghiera in ottone con guarnizione in plastica - Chromed brass ring with plastic gasket | 13,00 |
| | 53022 | R2553951 | Pompetta completa in ottone cromato per dosasapone in vetro e porcellana Brass chromed pump for glass and porcelaine soap dispenser |
| R2344090 | | Pompetta per dosatore inox - Pump for soap dispenser in stainless steel | 23,00 |
| R22440021 | | Tubetto in plastica per pompetta - Plastic tube for pump | 5,00 |
| R2653022 | | Bottiglia in vetro acidato - Etched glass bottle | 23,00 |
| R2153022 | | Bottiglia in porcellana - Porcelaine bottle | 49,00 |
| R2353022 | | Bottiglia in acciaio inox - Inox bottle | 61,00 |
| R2244002 | | Tubetto per pompetta - Plastic tube for pump | 5,00 |
| 61223.09 | R2553951 | Pompetta completa in ottone cromato per dosatore- Complete chromed brass pump for dispenser | 24,00 |
| 61223.23.09 | R245395123 | Pompetta completa in ottone verniciato nero opaco per dosatore - Complete matt black painted brass pump for dispenser | 28,00 |

portascopini

Toilet Brush Holders _ Porte-balais _ Wc Bürstenbehälter

Bianco opaco
Matt white
Laqué blanc mat
Matt Weiß



.09

Nero opaco
Matt black
Noir mat
Matt Schwarz

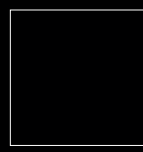

.23

Acciaio inox lucido
Polished stainless steel
Acier inoxydable brillant
Poliert Edelstahl



.29

Acciaio inox satinato
Satinated stainless steel
Acier inox satiné
Vereist Edelstahl



.32

Metallo bronzo
Bronze metal
Métal bronze
Bronze Metall



.35

Oro spazzolato
Gold brushed
Or brossé
Goldmetall gebürstet



.37

Gun Metall spazzolato
Gun Metal brushed
Gun Métal brossé
Gun Metal gebürstet



.38

Artic
Artic
Artic
Artic

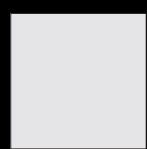

.90

Sailor Blue
Sailor Blue
Sailor Blue
Sailor Blue



.92

Grigio
Grey
Gris
Grau



.95

Sabbia
Sand
Sable
Sand



.98

Tortora
Tortora
Tortora
Tortora



.99

Sage
Sage
Sage
Sage



.73

Ambra
Ambra
Ambra
Ambra



.86

Silicone
Silicon
Silicone
Silikon



.09

Silicone
Silicon
Silicone
Silikon



.11

Silicone
Silicon
Silicone
Silikon



.13

Silicone
Silicon
Silicone
Silikon



.15

Silicone
Silicon
Silicone
Silikon



.16

Silicone
Silicon
Silicone
Silikon



.17

Silicone
Silicon
Silicone
Silikon



.18

Ceramica
Ceramic
Céramique
Keramik



.09

Rosa metallizzato opaco
Metallic pink matt
Rose métallisé mat
Metallisch rosa matt

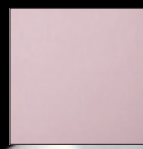

.55

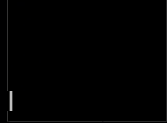

SKOATI

Portascopino da pavimento e a parete

Floor and wall toilet brush holder / Porte-balai mural ou à poser / Wand oder Boden WC Bürstengarnitur

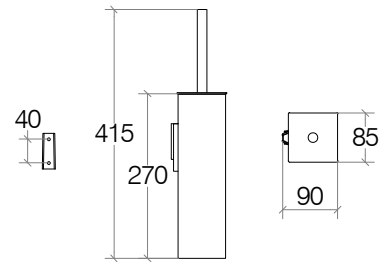

Acciaio verniciato
Painted stainless steel
Acier inox laqué
Lackiertem Edelstahl

Acciaio verniciato
Painted stainless steel
Acier inox laqué
Lackiertem Edelstahl

new

| | | |
|--------------|------------|------------|
| 50056 | .09 | .23 |
| € | 133,00 | 133,00 |



Acciaio inox lucido
Polished stainless steel
Acier inox brillant
Glänzer Edelstahl

Acciaio inox satinato
Satinated stainless steel
Acier inox satiné
Vereist Edelstahl

Metallo bronzo
Bronze metal
Métal bronze
Bronze Metall

Oro spazzolato
Gold brushed
Or brossé
Goldmetall gebürstet

Gun Metal spazzolato
Gun Metal brushed
Gun Métal brossé
Gun Metal gebürstet

Rosa metallizzato opaco
Metallic pink matt
Rose métallisé mat
Metallisch rosa matt

new

| | | | | | | |
|--------------|------------|------------|------------|------------|------------|------------|
| 50056 | .29 | .32 | .35 | .37 | .38 | .55 |
| € | 140,00 | 140,00 | 185,00 | 185,00 | 185,00 | 185,00 |



Portascopino

Toilet brush holder / Porte-balai / Wc-Bürstengarnitur

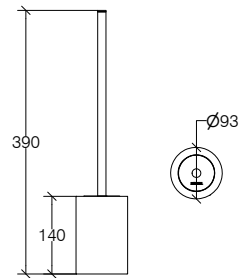

Ottone cromato
Chromed brass
Laiton chromé
Verchromtes Messing

Porcellana
Porcelaine
Porcelaine
Porzellan



| | |
|--------------|---------------|
| 50203 | .29.09 |
| € | 56,00 |

Portascopino da pavimento e a parete

Floor and wall toilet brush holder / Porte-balai mural ou à poser / Wand oder Boden WC Bürstengarnitur

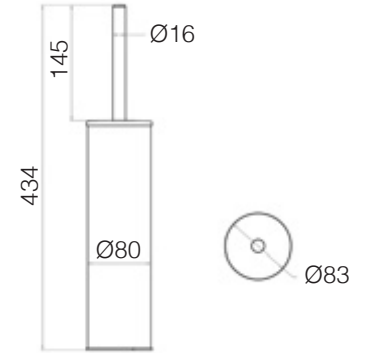

| | | | |
|--|--|---|--|
| Acciaio verniciato Painted stainless steel Acier inox laqué Lackiertem Edelstahl | Acciaio verniciato Painted stainless steel Acier inox laqué Lackiertem Edelstahl | Acciaio inox lucido Polished stainless steel Acier inox brillant Glänzender Edelstahl | Acciaio inox satinato Satinated stainless steel Acier inox satiné Verreist Edelstahl |
|--|--|---|--|



| | | | | |
|--------------|------------|------------|------------|------------|
| new | | | | |
| 50048 | .09 | .23 | .29 | .32 |
| € | 98,00 | 98,00 | 109,00 | 109,00 |

| | | | | | | |
|---|---|---------------------------------------|--|---|-------------------------------------|---|
| Artic Artic Artic Artic | Sailor Blue Sailor Blue Sailor Blue Sailor Blue | Grigio Grey Gris Grau | Sabbia Sand Sable Sand | Tortora Tortora Tortora Tortora | Sage Sage Sage Sage | Ambra Ambra Ambra Ambra |
|---|---|---------------------------------------|--|---|-------------------------------------|---|



| | | | | | | | |
|--------------|------------|------------|------------|------------|------------|------------|------------|
| new | | | | | | | |
| 50048 | .90 | .92 | .95 | .98 | .99 | .73 | .86 |
| € | 98,00 | 98,00 | 98,00 | 98,00 | 98,00 | 98,00 | 98,00 |



BASTON

Portascopino

Toilet brush holder / Porte-balai / Wc-Bürstengarnitur

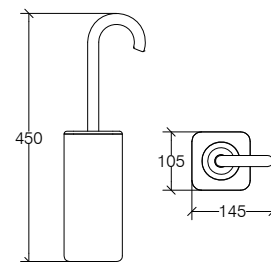

Silicone **Ceramica**
Silicon Ceramic
Silicone Céramique
Silikon Keramik



| | | |
|-------------|------------|------------|
| 5021 | .09 | .18 |
| € | 84,00 | 84,00 |

Portascopino

Toilet brush holder / Porte-balai / Wc-Bürstengarnitur

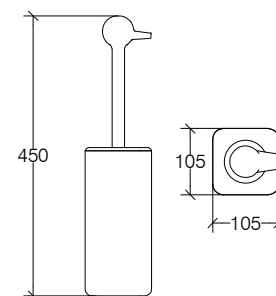

Silicone **Ceramica**
Silicon Ceramic
Silicone Céramique
Silikon Keramik



| | |
|-------------|------------|
| 5022 | .15 |
| € | 84,00 |

Portascopino

Toilet brush holder / Porte-balai / Wc-Bürstengarnitur

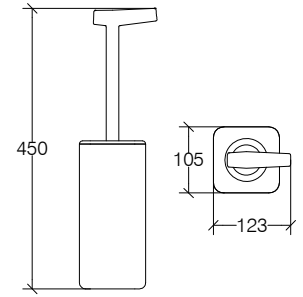

Silicone **Ceramica**
 Silicon Ceramic
 Silicone Céramique
 Silikon Keramik



| | |
|-------------|------------|
| 5023 | .11 |
| € | 84,00 |

Portascopino

Toilet brush holder / Porte-balai / Wc-Bürstengarnitur

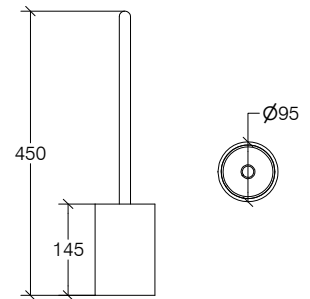
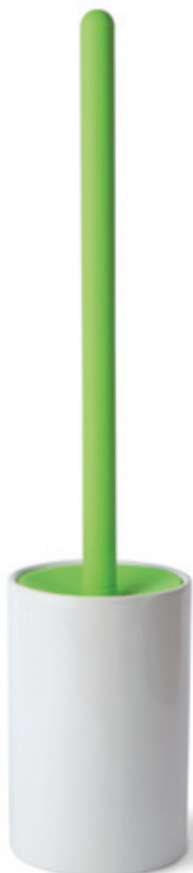

| | | | | | | | | | |
|-----------------|-----------------|-----------------|-----------------|-----------------|-----------------|-----------------|-----------------|-----------------|-----------------|
| Silicone | Ceramica | Silicone | Ceramica | Silicone | Ceramica | Silicone | Ceramica | Silicone | Ceramica |
| Silicon | Ceramic | Silicon | Ceramic | Silicon | Ceramic | Silicon | Ceramic | Silicon | Ceramic |
| Silicone | Céramique | Silicone | Céramique | Silicone | Céramique | Silicone | Céramique | Silicone | Céramique |
| Silikon | Keramik | Silikon | Keramik | Silikon | Keramik | Silikon | Keramik | Silikon | Keramik |

| | | | | | |
|-------------|------------|------------|------------|------------|------------|
| 5024 | .09 | .13 | .15 | .16 | .17 |
| € | 48,00 | 48,00 | 48,00 | 48,00 | 48,00 |

SKOATI _ BALENGHI

Portascopino

Toilet brush holder / Porte-balai / Wc-Bürstengarnitur

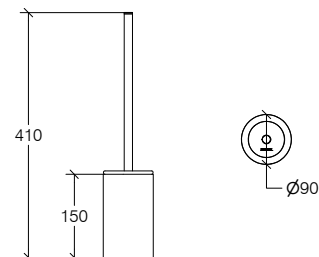

Ottone cromato
Chromed brass
Laiton chromé
Verchromtes Messing



| | |
|--------------|------------|
| 50207 | .29 |
| € | 89,00 |

Portascopino

Toilet brush holder / Porte-balai / Wc-Bürstengarnitur

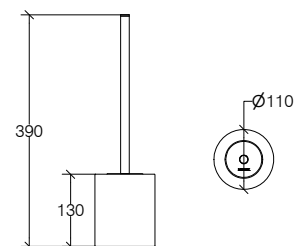

Acciaio inox lucido
Polished stainless steel
Acier inox brillant
Glänzer Edelstahl



| | |
|-------------|------------|
| 5008 | .29 |
| € | 90,00 |

Portascopino "BAJLE"

Toilet brush holder "BAJLE" / Porte-balai "BAJLE" / Toilettenbürstengarnitur "BAJLE"

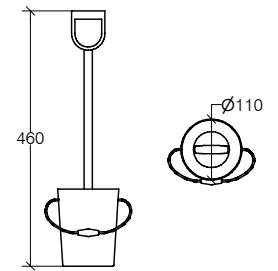

Acciaio inox lucido
Polished stainless steel
Acier inox brillant
Glänzer Edelstahl

**5010****.29**

€

142,00

**Portascopino "BUTTO"**

Toilet brush holder "BUTTO" / Porte-balai "BUTTO" / Toilettenbürstengarnitur "BUTTO"

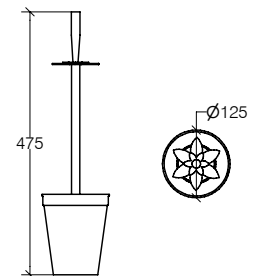

Acciaio inox lucido
Polished stainless steel
Acier inox brillant
Glänzer Edelstahl

**5011****.29**

€

142,00



BALENGHI

Portascopino "PESSÉ"

Toilet brush holder "PESSÉ" / Porte-balai "PESSÉ" / Toilettenbürstengarnitur "PESSÉ"

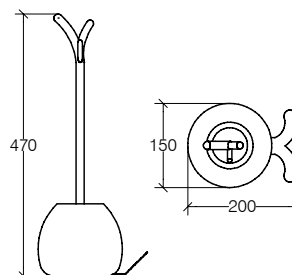

Acciaio inox lucido
Polished stainless steel
Acier inox brillant
Glänzer Edelstahl



| | |
|-------------|------------|
| 5012 | .29 |
| € | 142,00 |

Portascopino "VOVO"

Toilet brush holder "VOVO" / Porte-balai "VOVO" / Toilettenbürstengarnitur "VOVO"

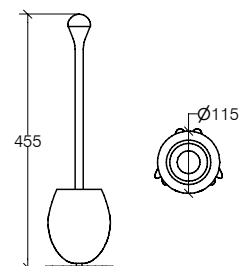

Acciaio inox lucido
Polished stainless steel
Acier inox brillant
Glänzer Edelstahl



| | |
|-------------|------------|
| 5013 | .29 |
| € | 142,00 |

Portascopino "LONGA"

Toilet brush holder "LONGA" / Porte-balai "LONGA" / Toilettenbürstengarnitur "LONGA"

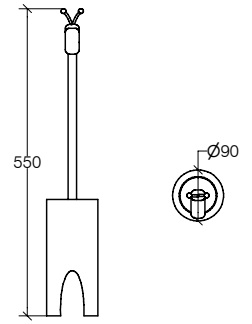

Acciaio inox lucido
Polished stainless steel
Acier inox brillant
Glänzer Edelstahl



| | |
|-------------|------------|
| 5014 | .29 |
| € | 142,00 |



Portascopino "CALA"

Toilet brush holder CALA" / Porte-balai "CALA" / Toilettenbürstengarnitur "CALA"

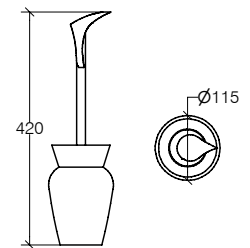

Acciaio inox lucido
Polished stainless steel
Acier inox brillant
Glänzer Edelstahl



| | |
|-------------|------------|
| 5015 | .29 |
| € | 142,00 |



Ricambi _ Spare parts _ Pièces détachées _ Ersatzteile

| | | | |
|--------------|------------|--|-------|
| 5021 | R2250057 | Ciuffo in silicone grigio - Silicon toilet brush grey | 14,00 |
| | R215021 | Tazza portascopino in ceramica - Ceramic toilet brush holder | 47,00 |
| 5022 | R2250057 | Ciuffo in silicone grigio - Silicon toilet brush grey | 14,00 |
| | R215021 | Tazza portascopino in ceramica - Ceramic toilet brush holder | 47,00 |
| | R22502215 | Manico e scopino silicone arancione - Orange silicon toilet brush and handle | 32,00 |
| 5023 | R2250057 | Ciuffo in silicone grigio - Silicon toilet brush grey | 14,00 |
| | R215021 | Tazza portascopino in ceramica - Ceramic toilet brush holder | 47,00 |
| | R22502311 | Manico e scopino silicone rosso - Silicon red toilet brush with handle | 32,00 |
| 5024 | R225023109 | Manico scopino silicone bianco - White silicon handle for toilet brush | 26,00 |
| | R225023113 | Manico scopino silicone verde - Green silicon handle for toilet brush | 26,00 |
| | R225023115 | Manico scopino silicone arancio - Orange silicon handle for toilet brush | 26,00 |
| | R225023116 | Manico scopino silicone fucsia - Fuchsia silicon handle for toilet brush | 26,00 |
| | R225023117 | Manico scopino silicone grigio - Grey silicon handle for toilet brush | 26,00 |
| | R2250061 | Setola scopino Ø 74 bianco - White toilet brush Ø 74 | 10,00 |
| | R215023 | Tazza scopino ceramica - Ceramic toilet brush holder | 34,00 |
| 50203 | R539329 | Manico scopino cromato con ciuffo - Toilet brush with chromed stick | 25,00 |
| | R2250054 | Copriscopino Ø 67 - Toilet brush lid Ø 67 | 7,00 |
| | R2250055 | Setola scopino - Toilet brush | 9,00 |
| | R2150203 | Tazza ceramica scopino - Toilet brush holde | 37,00 |
| | R2550069 | Manico scopino 300 mm - Toilet brush handle 300 mm | 19,00 |
| 50207 | R2651061 | Vaso vetro acidato per Portascopino - Etched glass toilet brush | 20,00 |
| | R539329 | Manico scopino cromato con ciuffo - Toilet brush with chromed stick | 25,00 |
| | R2250054 | Copriscopino Ø 67 - Toilet brush lid Ø 67 | 7,00 |
| | R2250055 | Setola scopino - Toilet brush | 9,00 |
| | R2550069 | Manico scopino 300 mm - Toilet brush handle 300 mm | 19,00 |
| | R2255061 | Guarnizione in silicone Ø 90 mm Silicon gasket Ø 90 mm | 6,00 |
| 5008 | R539329 | Manico scopino cromato con ciuffo - Toilet brush with chromed stick | 25,00 |
| | R2250054 | Copriscopino Ø 67 - Toilet brush lid Ø 67 | 7,00 |
| | R2250055 | Setola scopino - Toilet brush | 9,00 |
| | R2550069 | Manico scopino 300 mm - Toilet brush handle 300 mm | 19,00 |
| 5012 | R2250056 | Copri scopino - Toilet brush lid | 7,00 |
| | R2250055 | Setola scopino - Toilet brush | 9,00 |
| | R2550122 | Manico scopino Pesse - Toilet Brush stick for Pesse | 72,00 |
| | R2350121 | Tazza scopino balena inox - Toilet brush holder whale inox | 87,00 |
| 5011 | R2250056 | Copri scopino - Toilet brush lid | 7,00 |
| | R2250055 | Setola scopino - Toilet brush | 9,00 |
| | R2550112 | Manico scopino Butto - Toilet Brush stick for Butto | 72,00 |
| | R2350111 | Tazza scopino vaso inox - Toilet brush holder vase inox | 73,00 |

Spare parts _ Pièces détachées _ Ersatzteile _ **Ricambi**

| | | | |
|--------------|-----------|--|-------|
| 5013 | R2250056 | Copri scopino - Toilet brush lid | 7,00 |
| | R2250055 | Setola scopino - Toilet brush | 9,00 |
| | R2550132 | Manico scopino Vovo -Toilet Brush stick for Vovo | 72,00 |
| | R2350131 | Tazza scopino pulcino inox - Toilet brush holder chick inox | 80,00 |
| 5010 | R2250056 | Copri scopino - Toilet brush lid | 7,00 |
| | R2250055 | Setola scopino - Toilet brush | 9,00 |
| | R2550102 | Manico scopino Bajle - Toilet Brush stick for Bajle | 67,00 |
| | R2350101 | Tazza scopino secchiello inox - Toilet brush holder bucket polished inox | 80,00 |
| 5015 | R2250056 | Copri scopino - Toilet brush lid | 7,00 |
| | R2250055 | Setola scopino - Toilet brush | 9,00 |
| | R2550151 | Manico scopino Cala - Toilet Brush stick for Cala | 72,00 |
| | R2350151 | Tazza scopino 'CALA' inox - Toilet brush holder 'CALA' inox | 86,00 |
| | R2550142 | Manico scopino Longa - Toilet Brush stick for Longa | 72,00 |
| | R2350141 | Tazza scopino giraffa inox - Toilet brush holder giraffe inox | 87,00 |
| 5014 | R2250054 | Copri scopino - Toilet brush lid | 7,00 |
| | R2250055 | Setola scopino - Toilet brush | 9,00 |
| | R2550142 | Manico scopino Longa - Toilet Brush stick for Longa | 72,00 |
| | R2350141 | Tazza scopino giraffa inox - Toilet brush holder giraffe inox | 87,00 |
| 50056 | R50056001 | Setola scopino bianca - Toilet brush white | 11,00 |
| | R50056002 | Setola scopino grigia - Toilet brush grey | 11,00 |
| | R50056003 | Fondo trasparente - Trasparent base | 6,00 |
| | R50056004 | Tazza in plastica portascopino bianca - White plastic cup | 16,00 |
| | R50056005 | Tazza in plastica portascopino nera - Black plastic cup | 16,00 |
| | R50056006 | Confezione viti + tasselli - screws raw plug set | 9,00 |
| | R50056007 | Asta completa bianco opaco - Complete matte white rod | 45,00 |
| | R50056008 | Asta completa nero opaco - Complete matte black rod | 50,00 |
| | R50056009 | Asta completa acciaio lucido opaco - Complete polished stainless steel rod | 50,00 |
| | R50056010 | Asta completa bianco opaco - Complete satin-finish steel rod | 39,00 |
| 50048 | R50048001 | Asta completa bianco opaco - Complete matte white rod | 29,00 |
| | R50048002 | Asta completa nero opaco - Complete matte black rod | 29,00 |
| | R50048003 | Asta completa acciaio lucido opaco - Complete polished stainless steel rod | 22,00 |
| | R50048004 | Asta completa bianco opaco - Complete satin-finish steel rod | 25,00 |
| | R50048005 | Fondo trasparente - Trasparent base | 6,00 |
| | R50048006 | Tazza in plastica portascopino nera - Black plastic cup | 16,00 |
| | R50048007 | Confezione viti + tasselli - screws raw plug set | 9,00 |

piantane

Stands _ Ensembles d'accessoires sur pied _ Wc Kombination und Handtuchständer

FINITURE _ Finishes _ Finitions _ Ausführung:

Metallo verniciato bianco opaco

White painted Matt métal
Métal laqué blanc mat
Mattweiß lackiertes Metall

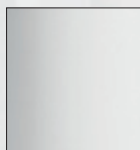

.09

Metallo nero opaco

Black matt metal
Métal noir mat
Matt Schwarz Metall

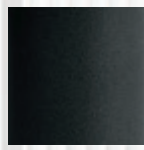

.23

Metallo verniciato Sage

Sage painted metal
Métal laqué Sage
Lackiertes Sage Metall



.73

Metallo verniciato Ambra

Ambra painted metal
Métal laqué Ambra
Lackiertes Ambra Metall



.86

Acciaio inox AISI304

AISI304 stainless steel
Acier inoxydable AISI304
AISI304 Edelstahl

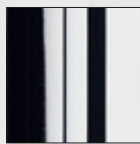

.29

Ottone cromato

Chromed brass
Laiton chromé
Verchromtes Messing



.29

Porcellana

Porcelaine
Porcelaine
Porzellan

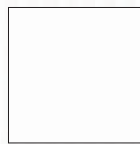

.09



GRELA

Scaletta portasalviette

Towel ladder / Echelle porte-serviettes / Handtuchleiter

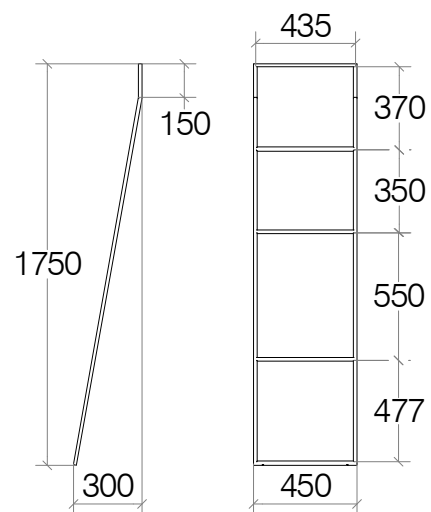

Acciaio verniciato
Painted steel
Acier laqué
Lackiertes edelstahl

Acciaio verniciato
Painted steel
Acier laqué
Lackiertes edelstahl

Acciaio inox lucido
Polished stainless steel
Acier inoxydable brillant
Poliertes Edelstahl



| | | | |
|------|--------|--------|--------|
| 5118 | .09 | .23 | .29 |
| € | 398,00 | 398,00 | 517,00 |



Scaletta portasalviette

Towel ladder / Echelle porte-serviettes / Handtuchleiter

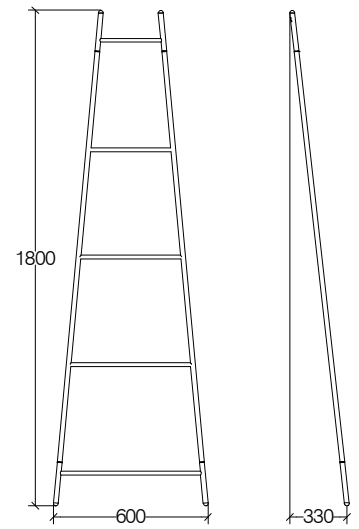

Verniciato bianco
White painted
Laqué blanc
Lackiertes weiß

Verniciato nero
Black painted
Laqué noir
Lackiertes Schwarz

Verniciato sage
Sage painted
Laqué sage
Lackiertes Sage

Verniciato ambra
Amبرا painted
Laqué amبرا
Lackiertes Amبرا



new

| | | | | |
|-------------|------------|------------|------------|------------|
| 5130 | .09 | .23 | .73 | .86 |
| € | 235,00 | 235,00 | 338,00 | 338,00 |



STELA

Piantana con vassoio, portarotolo e portascopino

Toilet paper and brush holder stand / Porte-rouleau et balai sur pied / Kombi-Bürstengarnitur mit Papierhalter und WC-Bürste

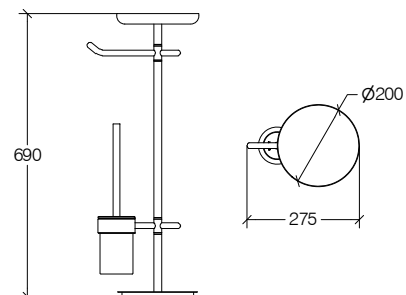

Metallo verniciato
Painted metal
Métal laqué
Lackiertes Metall

Metallo verniciato
Painted metal
Métal laqué
Lackiertes Metall



| | | |
|-------------|------------|------------|
| 5111 | .09 | .23 |
| € | 227,00 | 227,00 |

Piantana con portarotolo e portascopino

Toilet paper and brush holder stand / Porte-rouleau et balai sur pied / Kombi-Bürstengarnitur mit Papierhalter und WC-Bürste

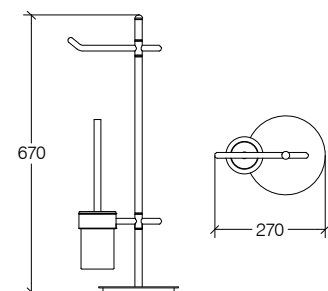

Metallo verniciato
Painted metal
Métal laqué
Lackiertes Metall

Metallo verniciato
Painted metal
Métal laqué
Lackiertes Metall



| | | |
|--------------|------------|------------|
| 51111 | .09 | .23 |
| € | 194,00 | 194,00 |

STELA

Piantana con 2 barre portasalvietta e vassoio

Towel-stand, 2 arms / Porte-serviettes 2 barres sur pied / Handtuchständer mit 2 Arme

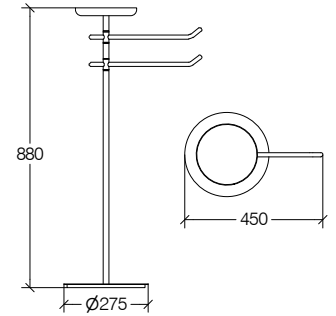

Metallo verniciato
Painted metal
Métal laqué
Lackiertes Metall

Metallo verniciato
Painted metal
Métal laqué
Lackiertes Metall



| | | |
|-------------|------------|------------|
| 5112 | .09 | .23 |
| € | 302,00 | 302,00 |

Piantana con 3 barre portasalvietta

Towel-stand, 3 arms / Porte-serviettes 3 barres sur pied / Handtuchständer mit 3 Arme

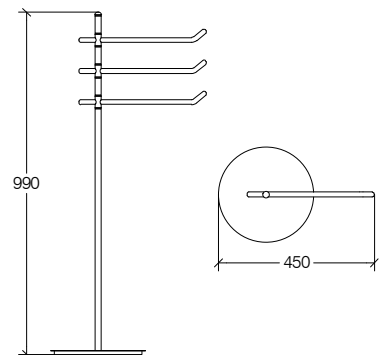

Metallo verniciato
Painted metal
Métal laqué
Lackiertes Metall

Metallo verniciato
Painted metal
Métal laqué
Lackiertes Metall



| | | |
|--------------|------------|------------|
| 51121 | .09 | .23 |
| € | 302,00 | 302,00 |

GRELA

Piantana portarotolo e portascopino

Toilet paper and brush holder stand / Porte-rouleau sur pied avec porte-balais / Kombi-Bürstengarnitur

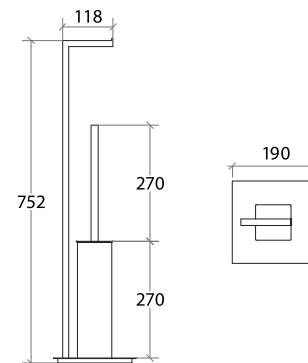

Acciaio verniciato
Painted steel
Acier laqué
Lackiertes edelstahl

Acciaio verniciato
Painted steel
Acier laqué
Lackiertes edelstahl

Acciaio inox lucido
Polished stainless steel
Acier inoxydable brillant
Polierter Edelstahl

Bronzo spazzolato
Brushed bronze
Bronze brossé
Bronze gebürstet

Rosa metallizzato
Metallic pink matt
Rose métallisé mat
Metallic-Rosa matt



new

| | | | | | |
|-------------|------------|------------|------------|------------|------------|
| 5116 | .09 | .23 | .29 | .35 | .55 |
| € | 386,00 | 386,00 | 458,00 | 635,00 | 635,00 |

Piantana portasalviette

Towel holder stand / Porte-serviettes sur pied / Handtuchständer

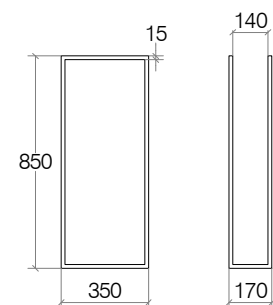

Verniciato bianco
Painted white
laqué blanc
Lackiertem Weiß

Verniciato nero
Painted black
laqué noir
Lackiertem Schwarz

Acciaio inox lucido
Polished stainless steel
Acier inoxydable brillant
Polierter Edelstahl

Bronzo spazzolato
Brushed bronze
Bronze brossé
Bronze gebürstet

Rosa metallizzato
Metallic pink matt
Rose métallisé mat
Metallic-Rosa matt



new

| | | | | | |
|-------------|------------|------------|------------|------------|------------|
| 5117 | .09 | .23 | .29 | .35 | .55 |
| € | 361,00 | 361,00 | 434,00 | 595,00 | 595,00 |



Piantana portarotolo e portascopino

Toilet paper and brush holder stand / Porte-rouleau sur pied avec porte-balais
Kombi-Bürstengarnitur mit Papierhalter und WC-Bürste

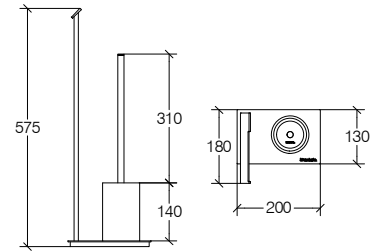

Porcellana
Porcelaine
Porcelaine
Porzellan

Acciaio inox lucido
Polished stainless steel
Acier inoxydable brillant
Polierter Edelstahl



| | |
|-------------|------------|
| 5113 | .29 |
| € | 308,00 |



Piantana portarotolo, portascopino e portasalvietta

Toilet brush and towel set / Porte-rouleau sur pied avec balais et porte-serviettes / Kombi-Bürstengarnitur und Tuch - halter

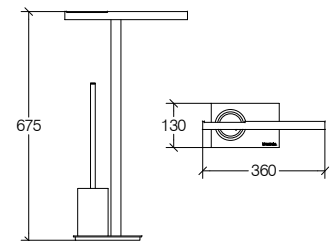

Porcellana
Porcelaine
Porcelaine
Porzellan

Acciaio inox lucido
Polished stainless steel
Acier inoxydable brillant
Polierter Edelstahl



| | |
|-------------|------------|
| 5114 | .29 |
| € | 336,00 |



RANPIN _ BAKETO

Piantana portasalviette

Towel holder stand / Porte-serviettes sur pied / Handtuchständer

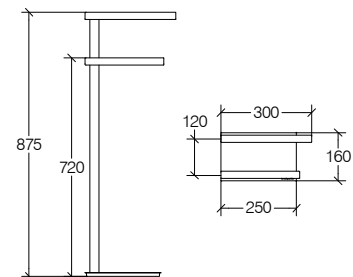

Acciaio inox lucido
Polished stainless steel
Acier inoxydable brillant
Polierter Edelstahl



5115 **.29**

€ **375,00**



Piantana portarotolo e portascopino

Toilet paper and brush holder stand / Porte-rouleau sur pied avec porte-balais / Kombi-Bürstengarnitur

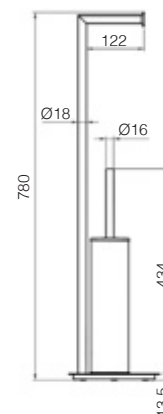
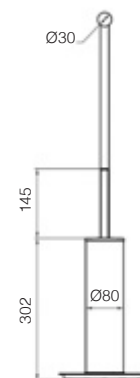

Acciaio verniciato
Painted steel
Acier laqué
Lackiertes edelstahl

Acciaio verniciato
Painted steel
Acier laqué
Lackiertes edelstahl

Acciaio inox lucido
Polished stainless steel
Acier inoxydable brillant
Polierter Edelstahl



new

5121

.09

.23

.29

€

294,00

294,00

350,00



Piantana portarotolo e portascopino

Toilet paper and brush holder stand / Porte-rouleau et balai sur pied / Kombi-Bürstengarnitur mit Papierhalter und WC-Bürste

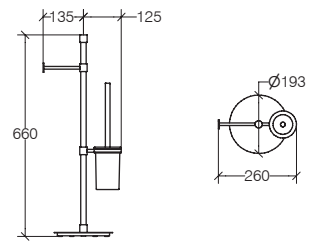

Ottone cromato
Chromed brass
Laiton chromé
Verchromtes Messing



5124

.29

€

209,00



Piantana portarotolo e portascopino

Toilet paper and brush holder stand / Porte-rouleau et balai sur pied / Kombi-Bürstengarnitur mit Papierhalter und WC-Bürste

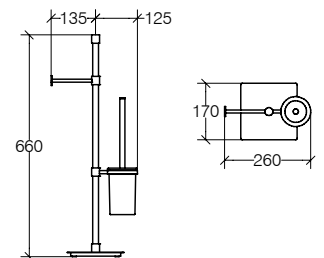

Ottone cromato
Chromed brass
Laiton chromé
Verchromtes Messing



51193

.29

€

216,00



RANPIN

Piantana 3 portasalviette

Towel-stand, 3 arms / Porte-serviettes 3 barres sur pied / Handtuchständer mit 3 Arme

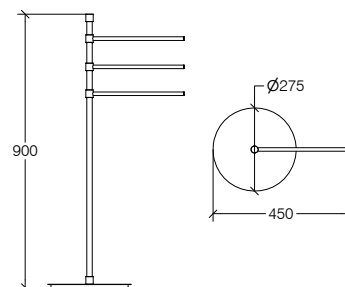

Ottone cromato
Chromed brass
Laiton chromé
Verchromtes Messing



| | |
|-------------|------------|
| 5120 | .29 |
| € | 240,00 |

Piantana 3 portasalviette

Towel-stand, 3 arms / Porte-serviettes 3 barres sur pied / Handtuchständer mit 3 Arme

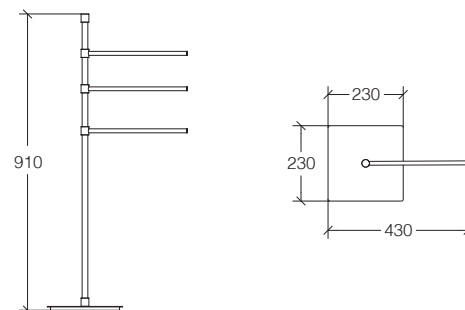

Ottone cromato
Chromed brass
Laiton chromé
Verchromtes Messing



| | |
|--------------|------------|
| 51191 | .29 |
| € | 249,00 |

Piantana appendiabiti

Hooks-stand / Porte-manteaux sur pied / Kleiderständer

**Combinabile con accessori di pagina 182-183**

Matching with accessories see page 182-183
 À équiper avec les accessoires page 182-183
 Verwendbar mit Zubehör Seite 182-183

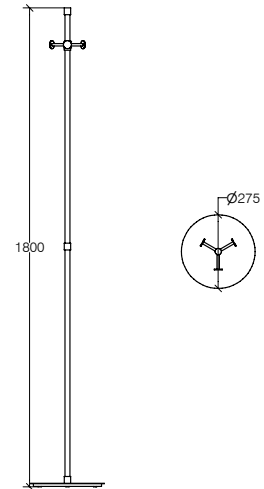

Ottone cromato
 Chromed brass
 Laiton chromé
 Verchromtes Messing



| | |
|-------------|------------|
| 5126 | .29 |
| € | 263,00 |

Piantana appendiabiti

Hooks-stand / Porte-manteaux sur pied / Kleiderständer

**Combinabile con accessori di pagina 182-183**

Matching with accessories see page 182-183
 À équiper avec les accessoires page 182-183
 Verwendbar mit Zubehör Seite 182-183

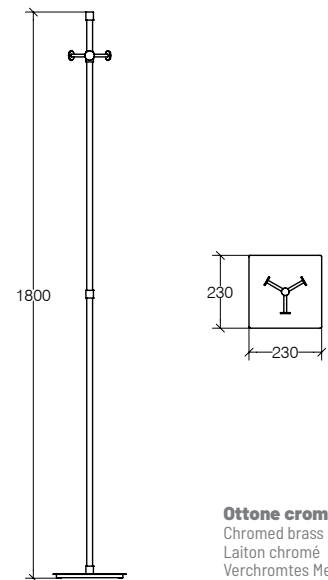

Ottone cromato
 Chromed brass
 Laiton chromé
 Verchromtes Messing



| | |
|--------------|------------|
| 51195 | .29 |
| € | 282,00 |

RANPIN

Piantana bassa attrezzabile

Customizable accessories stand, low / Porte-accessoires bas sur pied (à équiper) / Ständer Anpassbarer



Combinabile con accessori di pagina 182-183
 Matching with accessories see page 182-183
 À équiper avec les accessoires page 182-183
 Verwendbar mit Zubehör Seite 182-183

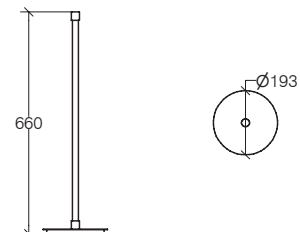

Ottone cromato
 Chromed brass
 Laiton chromé
 Verchromtes Messing



| | |
|--------------|------------|
| 51259 | .29 |
| € | 150,00 |

Piantana bassa attrezzabile

Customizable accessories stand, low / Porte-accessoires bas sur pied (à équiper) / Ständer Anpassbarer



Combinabile con accessori di pagina 182-183
 Matching with accessories see page 182-183
 À équiper avec les accessoires page 182-183
 Verwendbar mit Zubehör Seite 182-183

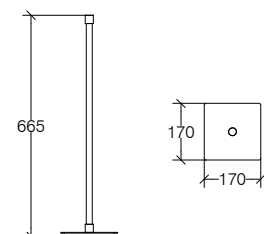

Ottone cromato
 Chromed brass
 Laiton chromé
 Verchromtes Messing



| | |
|--------------|------------|
| 51194 | .29 |
| € | 150,00 |

Piantana alta attrezzabile

Customizable accessories stand, tall / Porte-accessoires haut sur pied (à équiper) / Ständer Anpassbarer (groß)

**Combinabile con accessori di pagina 182-183**

Matching with accessories see page 182-183
 À équiper avec les accessoires page 182-183
 Verwendbar mit Zubehör Seite 182-183

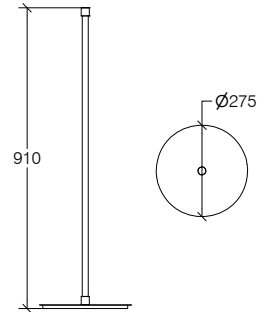

Ottone cromato
 Chromed brass
 Laiton chromé
 Verchromtes Messing



51239

.29

€

182,00

Piantana alta attrezzabile

Customizable accessories stand, tall / Porte-accessoires haut sur pied (à équiper) / Ständer Anpassbarer (groß)

**Combinabile con accessori di pagina 182-183**

Matching with accessories see page 182-183
 À équiper avec les accessoires page 182-183
 Verwendbar mit Zubehör Seite 182-183

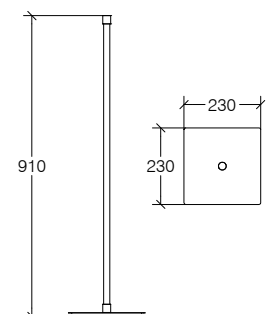

Ottone cromato
 Chromed brass
 Laiton chromé
 Verchromtes Messing



51192

.29

€

182,00

RANPIN

Portarotolo per barra

Toilet paper holder for rail / Porte-rouleau pour barre / Toilettenpapierhalter für Stange

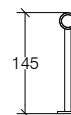

Ø30

Ottone cromato
Chromed brass
Laiton chromé
Verchromtes Messing



5226

.29

€

41,00

Supporto scopino per barra (compatibile con art.55062)

Toilet brush holder for rail (compatible with art.55062) / Support porte-balai pour barre (compatible avec art.55062)
Halter für Stange zu Toilettenbürsten (kompatibel mit Art.55062)

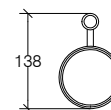
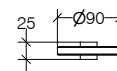

Ottone cromato
Chromed brass
Laiton chromé
Verchromtes Messing



52271

.29

€

33,00

Portasalvietta per barra

Towel rail for rail / Porte-serviettes pour barre / Handtuchhalter für Stange

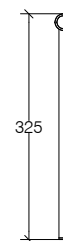

Ottone cromato
Chromed brass
Laiton chromé
Verchromtes Messing



5229

.29

€

46,00

Supporto per barra

Single holder for rail / Support pour barre / Halter für Stange

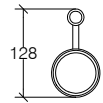
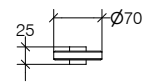

Ottone cromato
 Chromed brass
 Laiton chromé
 Verchromtes Messing



| | |
|--------------|------------|
| 52241 | .29 |
| € | 30,00 |

Esempio di piantana attrezzata

Example of accessoried stand / Porte-accessoires sur pied équipé (exemple) / Beispiel für Ständer mit Accessoires



Ricambi _ Spare parts _ Pièces détachées _ Ersatzteile

| | | | |
|--------------|----------|---|-------|
| 5113 | R2250055 | Setola scopino - Toilet brush | 9,00 |
| | R2550069 | Manico scopino 300 mm - Toilet brush handle 300 mm | 19,00 |
| | R539329 | Manico scopino cromato con ciuffo - Toilet brush with chromed stick | 25,00 |
| | R2250054 | Copri scopino - Toilet brush lid | 7,00 |
| 5114 | R2250055 | Setola scopino - Toilet brush | 9,00 |
| | R2550069 | Manico scopino 300 mm - Toilet brush handle 300 mm | 19,00 |
| | R539329 | Manico scopino cromato con ciuffo - Toilet brush with chromed stick | 25,00 |
| | R2250054 | Copri scopino - Toilet brush lid | 7,00 |
| 5120 | R2551202 | Copri base Ø 275 mm - Chromed stand base cover Ø 275 mm | 76,00 |
| | R2251201 | Anello PVC frenante - PVC braking ring | 5,00 |
| | R2251204 | Gommino antiscivolo Ø 8 mm - Slip resistant rubber Ø 8 mm | 6,00 |
| 5124 | R2550069 | Manico scopino 300 mm Toilet brush handle 300 mm | 19,00 |
| | R2652061 | Vaso vetro acidato per porta scopino - Etched glass toilet brush | 20,00 |
| | R539329 | Manico scopino cromato con ciuffo - Toilet brush with chromed stick | 25,00 |
| | R2250056 | Copri scopino - Toilet brush lid | 7,00 |
| | R2250055 | Setola scopino - Toilet brush | 9,00 |
| | R2255061 | Guarnizione in silicone Ø 90 mm - Silicon gasket Ø 90 mm | 6,00 |
| | R2251201 | Anello PVC frenante PVC braking ring | 5,00 |
| 5126 | R2551202 | Copri base Ø 275 mm - Chromed stand base cover Ø 275 mm | 76,00 |
| | R2251201 | Anello PVC frenante - PVC braking ring | 5,00 |
| | R51261 | Kit ricambio appendiabiti art, 5126 - Hooks replacement for art, 5126 | 30,00 |
| | R2251204 | Gommino antiscivolo Ø 8 mm - Slip resistant rubber Ø 8 mm | 6,00 |
| | R2551209 | Tubo lungo con terminale - Long tube with terminal | 68,00 |
| 51191 | R2551191 | Copri base 230x230 mm - Chromed base cover 230x230 mm | 76,00 |
| | R2251201 | Anello PVC frenante - PVC braking ring | 5,00 |
| | R2251204 | Gommino antiscivolo Ø 8 mm - Slip resistant rubber Ø 8 mm | 6,00 |

Spare parts _ Pièces détachées _ Ersatzteile _ **Ricambi**

| | | | |
|--------------|--------------|---|--|
| 51192 | R2551191 | Copribase 230x230 mm - Chromed base cover 230x230 mm | 76,00 |
| | R2251204 | Gommino antiscivolo Ø 8 mm - Slip resistant rubber Ø 8 mm | 6,00 |
| 51193 | R2550069 | Manico scopino 300 mm - Toilet brush handle 300 mm | 19,00 |
| | R2652061 | Vaso vetro acidato per porta scopino - Etched glass toilet brush | 20,00 |
| | R539329 | Manico scopino cromato con ciuffo - Toilet brush with chromed stick | 25,00 |
| | R2250056 | Copri scopino - Toilet brush lid | 7,00 |
| | R2250055 | Setola scopino - Toilet brush | 9,00 |
| | R2255061 | Guarnizione in silicone Ø 90 mm - Silicon gasket Ø 90 mm | 6,00 |
| | R2251201 | Anello PVC frenante - PVC braking ring | 5,00 |
| | 51194 | R2551193 | Copribase 170x170 mm - Chromed stand base cover 170x170 mm |
| R2251204 | | Gommino antiscivolo Ø 8 mm - Slip resistant rubber Ø 8 mm | 6,00 |
| 51195 | R2551191 | Copribase 230x230 mm - Chromed base cover 230x230 mm | 76,00 |
| | R2251201 | Anello PVC frenante - PVC braking ring | 5,00 |
| | R51261 | Kit ricambio appendiabiti art, 5126 - Hooks replacement for art, 5126 | 30,00 |
| | R2251204 | Gommino antiscivolo Ø 8 mm - Slip resistant rubber Ø 8 mm | 6,00 |
| 51239 | R2551202 | Copribase Ø 275 mm - Chromed stand base cover Ø 275 mm | 76,00 |
| | R2251204 | Gommino antiscivolo Ø 8 mm - Slip resistant rubber Ø 8 mm | 6,00 |
| 51259 | R2551242 | Copribase Ø 193 mm - Chromed stand base cover Ø 193 mm | 44,00 |
| | R2251204 | Gommino antiscivolo Ø 8 mm - Slip resistant rubber Ø 8 mm | 6,00 |
| 5111 | R2155062 | Vaso porta scopino in porcellana - Porcelaine toilet brush holder | 26,00 |
| | R2250055 | Setola scopino - Toilet brush | 9,00 |
| | R2250054 | Copriscopino Ø 67 - Toilet brush lid Ø 67 | 7,00 |
| 5111 | R2155062 | Vaso porta scopino in porcellana - Porcelaine toilet brush holder | 26,00 |
| | R2250055 | Setola scopino - Toilet brush | 9,00 |
| | R2250054 | Copriscopino Ø 67 - Toilet brush lid Ø 67 | 7,00 |

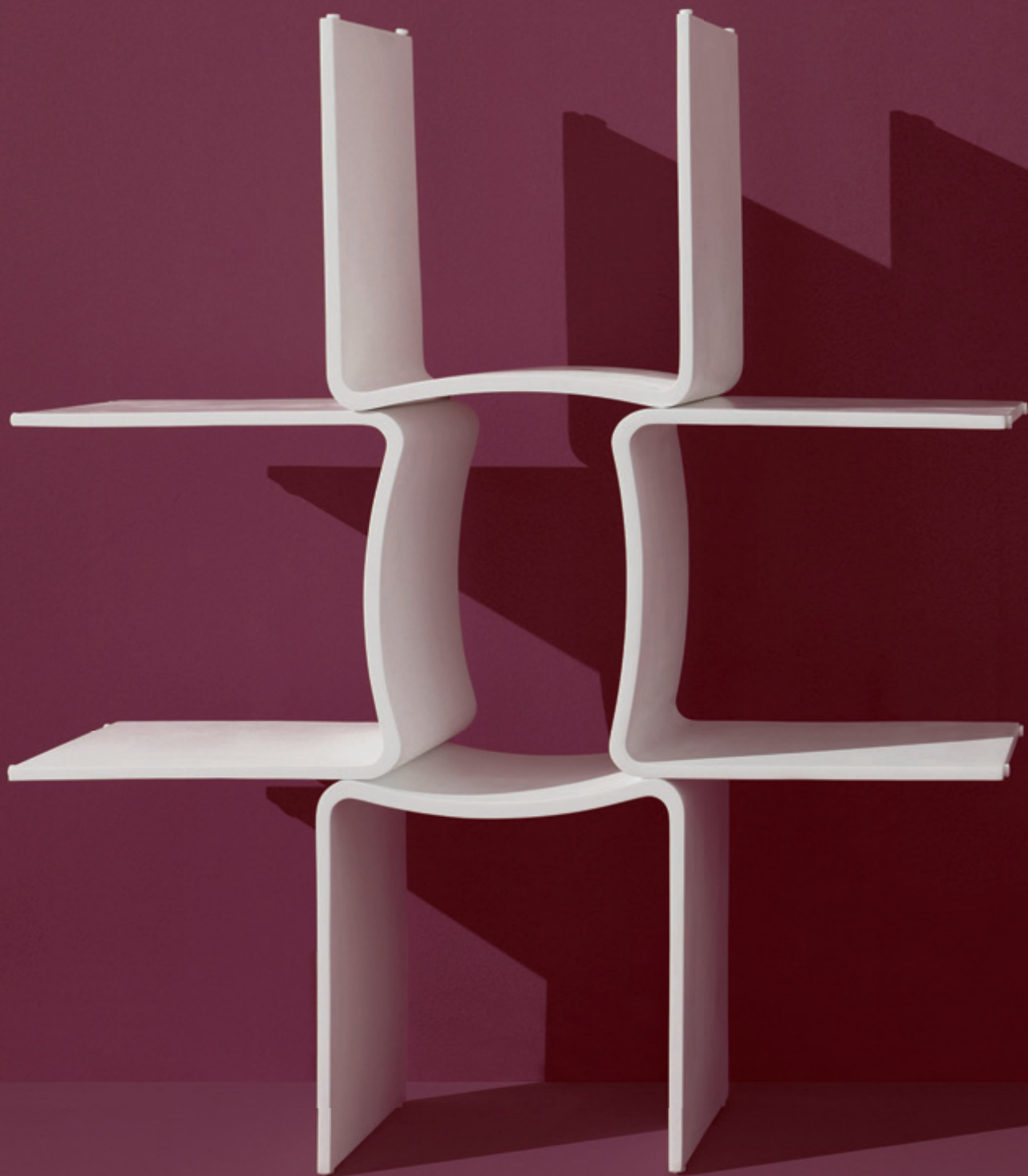

complementi

Complements _ Compléments _ Ergänzungen

Portabiancheria _ 188

Laundry baskets _ Paniers à linge _ Wäschekorb

Sgabelli _ 192

Stools _ Tabourets _ Hocker

Finiture _ Finishes _ Finitions _ Ausführung:

Alluminio verniciato bianco opaco

Matt white painted aluminium
Aluminium laqué blanc mat
Lackiertem Aluminium Weiß Matt

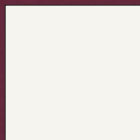

.09

Alluminio verniciato nero opaco

Matt black painted aluminium
Aluminium laqué noir mat
Lackiertem Aluminium Schwarz Matt



.23

Acciaio inox lucido

Polished stainless steel
Acier inoxydable brillant
Polierter Edelstahl

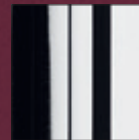

.29



BANDONI

Gettacarta

Paper basket / Poubelle à papier / Papierkorb

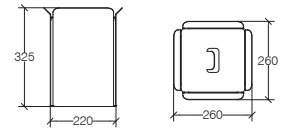

Alluminio verniciato
Painted aluminium
Aluminium laqué
Lackiertem Aluminium



53442

.09

.23

€

140,00

140,00

Portabiancheria con sacco in cotone (lavabile)

Laundry basket with cotton bag (washable) / Panier à linge avec sac en coton (lavable) / Wäschekorb mit Baumwolle Sack (waschbar)

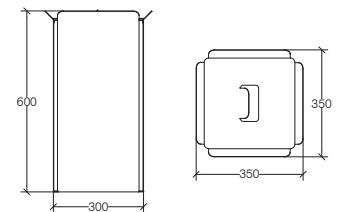

Alluminio verniciato
Painted aluminium
Aluminium laqué
Lackiertem Aluminium



53443

.09

.23

€

255,00

255,00

Portabiancheria con sacco in cotone (lavabile)

Laundry basket with cotton bag (washable) / Panier à linge avec sac en coton (lavable) / Wäschekorb mit Baumwolle Sack (waschbar)

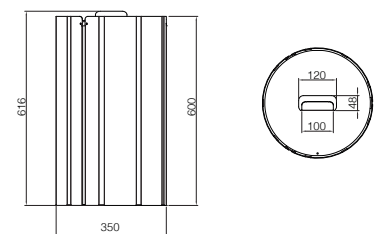

Alluminio verniciato
Painted aluminium
Aluminium laqué
Lackiertem Aluminium



new

53444

.09

.23

€

285,00

285,00



SESTEI

Pattumiera con secchiello 3 lt

Dustbin with bucket / Poubelle avec seau / Abfalleimer mit Eimer

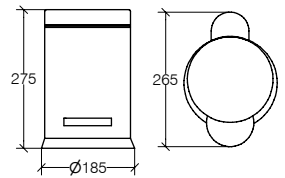

Acciaio inox lucido
Polished stainless steel
Acier inoxydable brillant
Poliert Edelstahl



| | |
|--------------|------------|
| 53297 | .29 |
| € | 79,00 |

Pattumiera con secchiello 6 lt

Dustbin with bucket / Poubelle avec seau / Abfalleimer mit Eimer

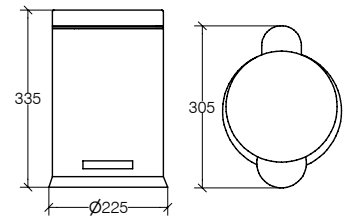

Acciaio inox lucido
Polished stainless steel
Acier inoxydable brillant
Poliert Edelstahl



| | |
|--------------|------------|
| 53298 | .29 |
| € | 103,00 |

Pattumiera con secchiello 3 lt

Dustbin with bucket / Poubelle avec seau / Abfalleimer mit Eimer

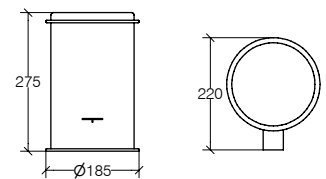

Acciaio inox lucido
Polished stainless steel
Acier inoxydable brillant
Poliert Edelstahl



| | |
|-------------|------------|
| 5344 | .29 |
| € | 130,00 |

SESTEI

Pattumiera con secchiello 5 lt

Dustbin with bucket / Poubelle avec seau / Abfalleimer mit Eimer

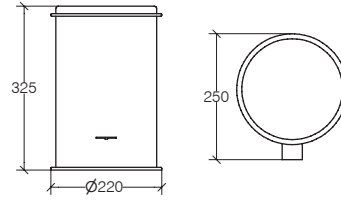

Acciaio inox lucido
Polished stainless steel
Acier inoxydable brillant
Poliert Edelstahl



5347

.29

€

140,00

Gettacarta

Paper basket / Corbeille à papier / Papierkorb

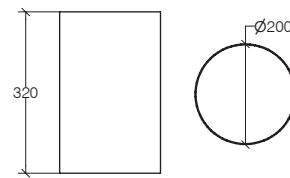

Acciaio inox lucido
Polished stainless steel
Acier inoxydable brillant
Poliert Edelstahl

Acciaio inox verniciato
Painted stainless steel
Acier inoxydable laqué
Lackiertem Edelstahl



5345

.29

.23

€

90,00

100,00

Pattumiera con coperchio basculante

Dustbin with tilting lid / Poubelle avec couvercle à bascule / Abfalleimer mit Kippdeckel

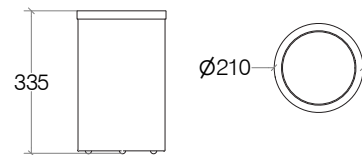

Acciaio inox verniciato
Painted stainless steel
Acier inoxydable laqué
Lackiertem Edelstahl



5358

.23

€

236,00

Bidoncino da tavolo tondo

Round table paper bin / Petite corbeille de table ronde / Tischabfallbehälter rund

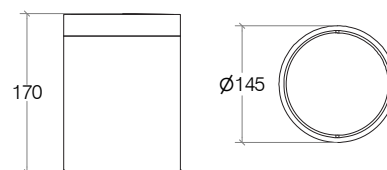

Acciaio verniciato
Painted steel
Acier laqué
Lackiertem Stahl



5359

.23

€

135,00

SESTEI

Pattumiera con secchiello 5 lt

Dustbin with bucket 5 Lt / Poubelle avec seau 5 Lt / Abfalleimer mit Eimer 5 Lt



NEW

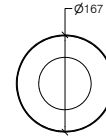
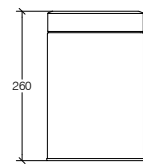

Acciaio inox lucido
Polished stainless steel
Acier inoxydable brillant
Poliert Edelstahl

Acciaio inox verniciato
Painted stainless steel
Acier inoxydable laqué
Lackiertem Edelstahl



new

5354

.29

.23

€

52,00

62,00

Pattumiera con secchiello 9 lt

Dustbin with bucket 9 Lt / Poubelle avec seau 9 Lt / Abfalleimer mit Eimer 9 Lt

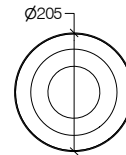
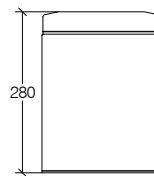

Acciaio inox lucido
Polished stainless steel
Acier inoxydable brillant
Poliert Edelstahl

Acciaio inox verniciato
Painted stainless steel
Acier inoxydable laqué
Lackiertem Edelstahl



5355

.29

.23

€

57,00

75,00

Pattumiera rettangolare 12 lt

Rectangular dustbin 12 Lt / Poubelle rectangulaire 12 Lt / Rechteckig Abfalleimer 12 Lt



Fino ad esaurimento scorte
While stocks last
Jusqu'à épuisement des stocks
Solange der Vorrat reicht

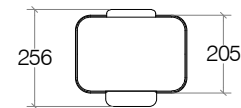
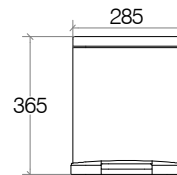

Acciaio inox satinato
Satinated stainless steel
Acier inoxydable satiné
Vereist Edelstahl



5357

.32

€

134,00

Portabiancheria forato con coperchio

Perforated laundry basket with lid / Panier à linge percée avec couvercle / Wäschekorb gelocht mit Deckel

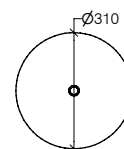
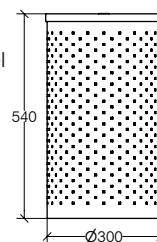

Acciaio inox lucido
Polished stainless steel
Acier inoxydable brillant
Poliert Edelstahl



5351.29

.29

€

198,00

GRELA

Piano sgabello Grela

Tray for stool / Plateau pour tabouret / Tablett für Hocker

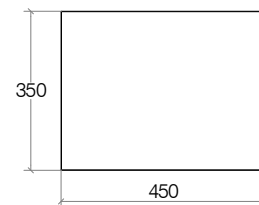

Laccato lucido
Glossy lacquered
Laqué brillant
Glänzend Lackiert

| | | | | |
|-------------|-------------|-------------|-------------|-------------|
| 8292 | .09L | .17L | .21L | .22L |
| € | 187,00 | 187,00 | 187,00 | 187,00 |

Laccato opaco
Mat lacquered
Laqué mat
Matt Lackiert

| | | | | |
|-------------|------------|------------|------------|------------|
| 8292 | .09 | .17 | .21 | .22 |
| € | 165,00 | 165,00 | 165,00 | 165,00 |

Laminato
Laminated
Stratififié
Holzlaminat

| | | | | |
|-------------|------------|------------|------------|------------|
| 8292 | .03 | .01 | .02 | .05 |
| € | 98,00 | 98,00 | 98,00 | 98,00 |

Struttura sgabello Grela

Frame for stool / Structure pour tabouret / Gestell für Hocker

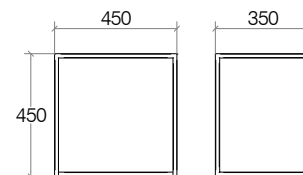
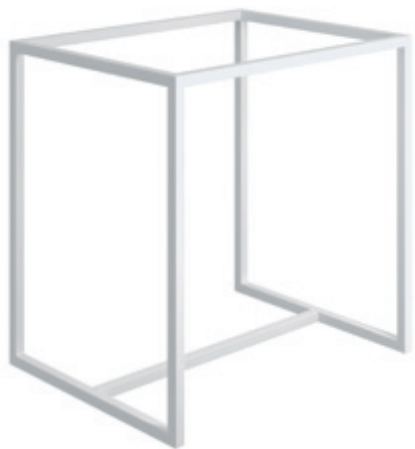

Acciaio verniciato
Painted steel
Acier laqué
Lackiertem Stahl



Acciaio verniciato
Painted steel
Acier laqué
Lackiertem Stahl



Acciaio inox lucido
Polished stainless steel
Acier inoxydable brillant
Poliert Edelstahl



| | | | |
|--------------|------------|------------|------------|
| 82921 | .09 | .18 | .29 |
| € | 251,00 | 251,00 | 501,00 |



SCAGNI

Sgabello

Stool / Tabouret / Hocker

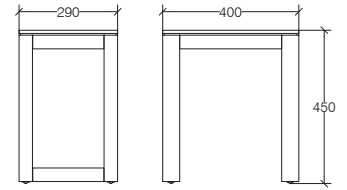

Bambù verniciato
Vernished Bamboo
Bambou verni
Zinnobambus



81119

.03

€

301,00

Panca

Bench / Banc / Bank

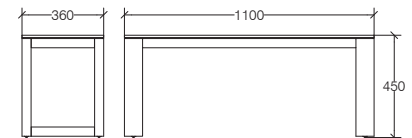

Bambù verniciato
Vernished Bamboo
Bambou verni
Zinnobambus



81120

.32

€

524,00

SCAGNI

Sgabello

Stool / Tabouret / Hocker



Portata max 150 Kg
Max weight 150 Kg
Poids maximal 150 Kg
Max gewicht 150 Kg

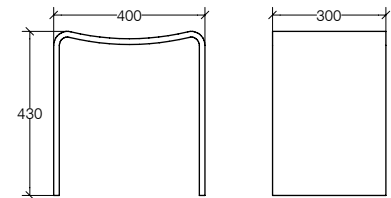

Mattstone
Mattstone
Mattstone
Mattstone



54703

.26

€

334,00

Sedile doccia in teak

Teak shower seat / Siège de douche en teak / Duschsitz aus Teak



Portata max 130 Kg
Max weight 130 Kg
Poids maximal 130 Kg
Max gewicht 130 Kg

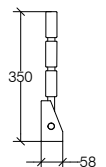
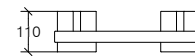
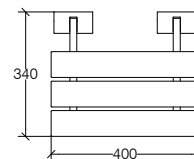

Acciaio inox - Teak
Stainless steel - teak wood
Acier inoxydable - Teak
Edelstahl - Teak



54720

.29

€

240,00

Sedile ribaltabile per doccia. Antibatterico

Folding shower seat. Antibacterial / Siège relevable pour douche. Antibactérien / Klappbarer Duschsitz. Antibakteriell.



Portata max 160 Kg
Max weight 160 Kg
Poids maximal 160 Kg
Max gewicht 160 Kg

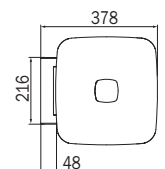
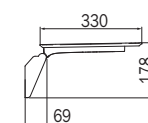

ABS
ABS
ABS
ABS



54722

.09

€

235,00

Ricambi / Spare parts / Pièces détachées / Ersatzteile

| | | | |
|--------------|----------|--|-------|
| 53442 | R2253442 | Chiodino silicone blocca sacchetto - Silicon stud bag blocks | 6,00 |
| 53443 | R3053443 | Sacco in tessuto bianco per art. 53443 - White fabric bag for art. 53443 | 57,00 |
| 5350 | R2353503 | Coperchio Ø 200 mm - Lid Ø 200 mm | 37,00 |
| 5351 | R2353513 | Coperchio Ø 300 mm - Lid Ø 300 mm | 51,00 |
| 5352 | R2353523 | Coperchio Ø 350 mm - Lid Ø 350 mm | 57,00 |
| 54720 | R2254720 | Copertura ABS e attacco a muro - Wall ABS cover and fix kit | 8,00 |



doccia

shower _ douche _ Dusche

Doccia da esterni _ 198

Outdoor shower _ Douche pour usage externe _ Aussendusche beweglich

Doccia componibile - 202

Shower enclosure componibile _ Paroi de douche modulaire _ Duschkabine komponierbar

Colonne doccia _ 204

Shower columns and hand shower _ Colonnes de douche et douchettes _ Duschsäulen und Handbrause

Soffioni e bracci doccia _ 209

Shower heads and shower-arms _ Pommets de douche et bras de douche _ Kopfbrause und Brausearm

Pedane doccia - 227

Shower mats _ Caillebotis _ Duschfußbrett

Griglie e accessori doccia - 228

Shower baskets and shower accessories _ Paniers et accessoires douche _ Duschkörbe und Duschzubehöre

Istà



Doccia da esterni

Outdoor shower _ Douche pour usage externe _ Aussendusche beweglich

Istà: estate.

Doccia da esterni mobile, che come l'estate viene riposta per poi ritornare. Estremamente leggera, perfetta per ambienti outdoor stagionali.

Designer: Studio JoeVelluto

EN

Istà:
summer.

Extremely light outdoor shower, perfect for seasonal outdoor environments.

The versatility of this product makes it suitable for various types of spaces and needs: it can be connected directly to the garden hose for a freer and less stationary use as well as to a traditional plumbing system.

Designer: Studio JoeVelluto

FR

Istà :
l'Été.

Douche mobile d'extérieur, qui comme l'Été s'en va pour mieux revenir. Extrêmement légère, elle est parfaite pour les espaces outdoor saisonniers.

Concepteur : Studio JoeVelluto

DE

Istà:
Sommer.

Mobile Dusche für den Außenbereich, äußerst leicht und ideal für saisonal genutzte Außenbereiche.

Mit seiner Vielseitigkeit ist dieses Produkt für verschiedene Arten von Bereichen und Anforderungen geeignet:

die Dusche kann für einen freien und mobilen Gebrauch direkt an den Gartenschlauch oder aber an eine traditionelle Wasserversorgung angeschlossen werden.

Designer: Studio JoeVelluto

Finiture _ Finishes _ Finitions _ Ausführung:

Polietilene bianco

White polyethylene
Polyéthylène blanc
Polyäthylen Weiß



.26

Acciaio inox verniciato

Painted stainless steel
Acier inoxydable verni
Lackierter Edelstahl

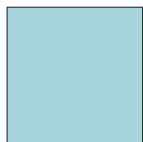

.20

ISTÀ



ISTÀ

ISTÀ

Doccia da esterni mobile con base in polietilene, staffa e soffione in metallo verniciato a polveri

Outdoor movable shower. Polyethylene base, dust painted metal tubular and shower head

Douche mobile pour usage externe, base en polyéthylène, colonne et pomme de douche en acier verni à poudre

Aussendusche beweglich mit Fuß aus Polyäthylen, Kolumn und Duschkopf aus lackiertem Edelstahl

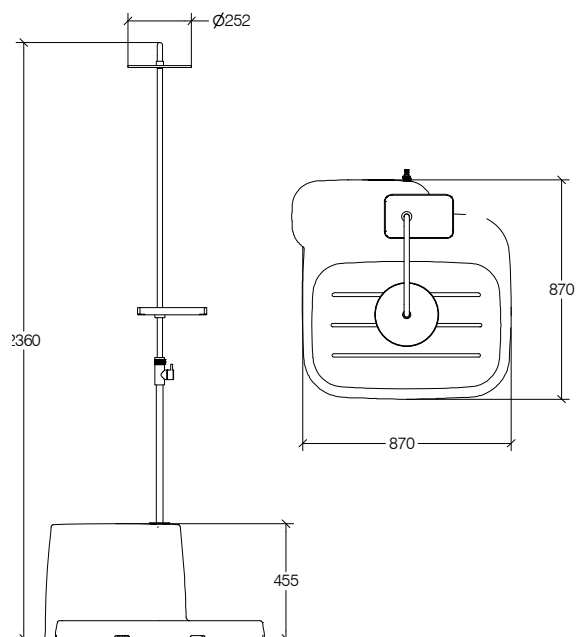
**CARATTERISTICHE IDRAULICHE**

Hydraulic features _ Caractéristiques hydrologiques - Hydraulische Merkmale

PORTATA

Water flow _ Débit d'eau _ Wasserdurchfluss

6 ÷ 8L/min

PRESSIONE RETE

Network pressure _ Pression du réseau _ Druck im Netz

Min 1,6 ÷ 4,5 Max bar

53830.09

.20

€

1387,00

TOKI

Parete doccia componibile durante l'installazione

Shower enclosure modular during installation / Paroi de douche modulaire lors de l'installation / Duschkabine modular während der Installation



| COD. | Misure Measures Mesures Maße | Pannelli Panels Panneaux Paneele | .96 |
|-----------------|--|--|------------|
| 54300.80 | 78-79,5 | TR | 361,00 |
| 54301.80 | 88-89,5 | TR | 381,00 |
| 54302.80 | 98-99,5 | TR | 399,00 |
| 54304.80 | 117-118,5 | TR | 440,00 |
| 54306.80 | 138-139,5 | TR | 487,00 |

Download x

54300
54301
54302
54304



Download x

54306



Parete doccia componibile durante l'installazione

Shower enclosure modular during installation / Paroi de douche modulaire lors de l'installation / Duschkabine modular während der Installation



| COD. | Misure Measures Mesures Maße | Pannelli Panels Panneaux Paneele | .96 |
|-----------------|--|--|---------------|
| 54310.80 | 78-79,5 | TR | 361,00 |
| 54311.80 | 88-89,5 | TR | 381,00 |
| 54312.80 | 98-99,5 | TR | 399,00 |
| 54314.80 | 117-118,5 | TR | 440,00 |
| 54316.80 | 138-139,5 | TR | 487,00 |
| 54318.80 | 158-159,5 | TR | 538,00 |

Download x

54310
54311
54312
54314
54316
54318



.96



Lineabeta **samo** 204

Colonne, Soffioni e bracci doccia

Shower column, Shower heads and shower-arms _ Colonne de douche, Pommès de douche et bras de douche
Duschsäule Kopfbrause und Brausearm

Supioni:

nel gergo, quei palloncini leggeri che invadono le campagne al termine della fioritura dei tarassachi.

Avvolgenti getti di benessere dalla collezione di soffioni doccia, disponibili in diverse dimensioni e forme per esclusivi momenti di relax.

EN

Supioni:

in slang, those light balloons that invade the countryside at the end of the flowering stage of dandelions.

Enveloping jets of wellness from the collection of shower heads, available in different sizes and shapes for those exclusive moments of relaxation.

FR

Supioni :

en argot, ce sont les duvets légers qui envahissent la campagne en fin de floraison des pissenlits.

Une collection de pommeaux de douche aux jets enveloppants de bien-être, disponibles en différentes tailles et formes pour des moments exclusifs de détente.

DE

Supioni:

im Jargon jene leichten Bällchen, die das Land am Ende der Löwenzahnblüte überziehen.

Hüllende Strahlen des Wohlbefindens gehen von den Duschköpfen dieser Kollektion aus, die in verschiedenen Größen und Formen für exklusive Augenblicke der Entspannung sorgen.

Finiture _ Finishes _ Finitions _ Ausführung:

Alluminio Artie opaco

Artie matt aluminium
Aluminium Artie mat
Matt Artie Aluminium



.90

Alluminio sabbia opaco

Sand matt aluminium
Aluminium sable mat
Matt Aluminium Sand



.98

Ottone cromato

Chromed brass
Laiton chromé
Verchromtes Messing



.29

Alluminio Nickel spazzolato

Brushed nickel aluminium
Aluminium nickel brossé
Gebürstetes Nickelaluminium



.36

Alluminio bianco opaco

White matt aluminium
Aluminium blanc mat
Matt Aluminium Weiß



.91

Alluminio Tortora opaco

Tortora matt aluminium
Aluminium Tortora mat
Matt Aluminium Tortora



.99

Acciaio inox lucido

Polished stainless steel
Acier inoxydable brillant
Poliert Edelstahl



.29

Alluminio Sailor blue opaco

Sailor blue matt aluminium
Aluminium Sailor blue mat
Matt Aluminium Sailor blue



.92

Alluminio nero opaco

Black matt aluminium
Aluminium noir mat
Matt Aluminium Schwarz



.96

Alluminio satinato

Satin aluminium
Aluminium satiné
Satinert Aluminium



.32

Acciaio inox spazzolato

Brushed stainless steel
Acier inoxydable brossé
Gebürstetes Edelstahl



.32

Alluminio grigio opaco

Grey matt aluminium
Aluminium gris mat
Matt Aluminium Grau



.95

Acciaio inox nero opaco

Black matt stainless steel
Acier inoxydable noir mat
Matt Schwarz Edelstahl



.23

Ottone nero opaco

Black matt brass
Laiton noir mat
Matt Schwarz Messing



.23

SUPIONI

Colonna doccia in alluminio completa con miscelatore termostatico, soffioni e doccetta

Aluminium shower column complete with with thermostatic mixer, shower heads and hand shower
 Colonne de douche en aluminium avec avec mitigeur thermostatique, pomme de douche et douchette
 Aluminium Duschsäule mit Mischer Thermostatmischer, Duschköpfen und Handbrause

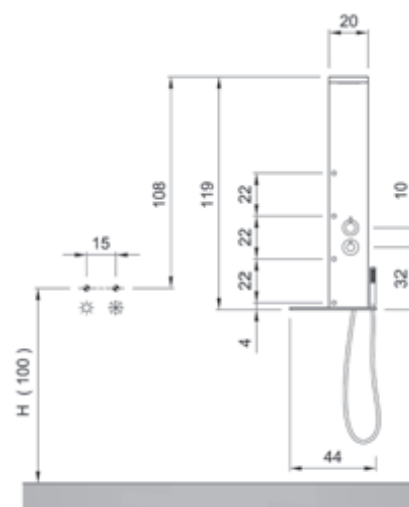
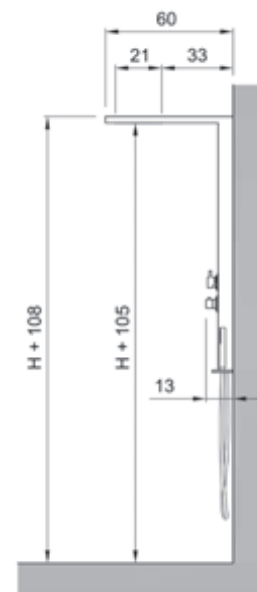

| CARATTERISTICHE IDRAULICHE | |
|---|--|
| Hydraulic features _ Caractéristiques hydrologiques - Hydraulische Merkmale | |
| PORTATA Water flow _ Débit d'eau _ Wasserdurchfluss | PRESSIONE RETE Network pressure _ Pression du réseau _ Druck im Netz |
| 6 ÷ 8L/min | Min 1,6 ÷ 4,5 Max bar |

| COD. | Misure | .90-.91-.92 | | .95-.96-.98 | |
|----------|-----------|-------------|---------|-------------|---------|
| | Measures | .99 | | .32 | |
| 54190.nn | 119-44-60 | 1041,00 | 1041,00 | 1041,00 | 1145,00 |
| | | | | | |

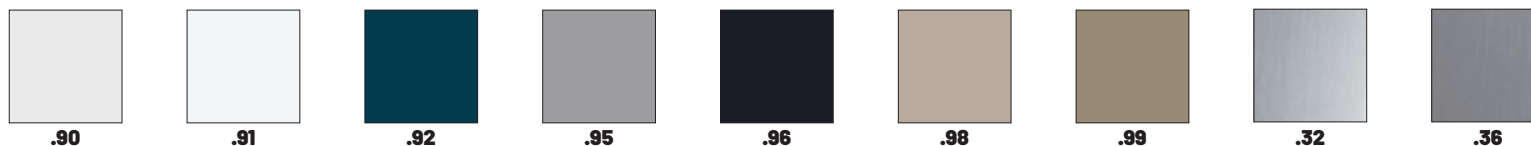

Colonna doccia in acciaio inox completa con miscelatore termostatico, soffioni e doccetta

Stainless steel shower column complete with with thermostatic mixer, shower heads and hand shower
 Colonne de douche en acier inoxydable avec avec mitigeur thermostatique, pomme de douche et douchette
 Edelstahl duschsäule mit Mischer Thermostatmischer, Duschköpfen und Handbrause

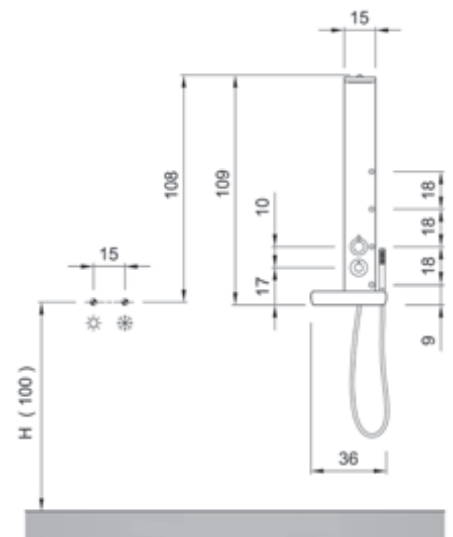
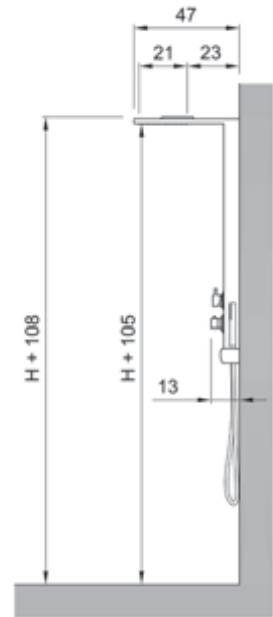
**CARATTERISICHE IDRAULICHE**

Hydraulic features _ Caractéristiques hydrologiques - Hydraulische Merkmale

| PORTATA Water flow _ Débit d'eau _ Wasserdurchfluss | PRESSIONE RETE Network pressure _ Pression du réseau _ Druck im Netz |
|--|---|
| 1,2 ÷ 8L/min | Min 1,6 ÷ 4,5 Max bar |



COD.

54191.09

Misure
Measures
Mesures
Maße

119-44-60

.29

1379,00



.29

SUPIONI

Colonna doccia in acciaio inox completa con miscelatore e doccetta

Stainless steel shower column complete with mixer and handshower

Colonne de douche en acier inoxydable avec mitigeur et douchette

Edelsthal duschsäule mit Mischer und Handbrause

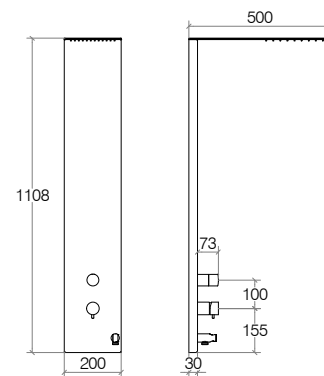

Acciaio inox lucido
Polished stainless steel
Acier inoxydable brillant
Poliert Edelstahl

Acciaio inox spazzolato
Brushed stainless steel
Acier inoxydable brossé
Gebürstetes Edelstahl



53915

.29

.32

€

853,00

986,00



CARATTERISTICHE IDRAULICHE

Hydraulic features _ Caractéristiques hydrologiques - Hydraulische Merkmale

PORTATA

Water flow _ Débit d'eau _ Wasserdurchfluss

4,70 ÷ 8,50L/min

PRESSIONE RETE

Network pressure _ Pression du réseau _ Druck im Netz

Min 1 ÷ 5 Max bar



Soffione a soffitto quadro 680 x 220 mm in acciaio inox con cascata e aspiratore vapore

Stainless steel built-in square 680 x 220 mm shower head, with waterfall and steam extractor

Pomme de douche en acier inoxydable de plafond carrée 680 x 220 mm avec cascade et extracteur de vapeur

Edelsthal Kopfbrause quadratisch am Decken 680 x 220 mm mit Wasserfall und Dampfextraktor

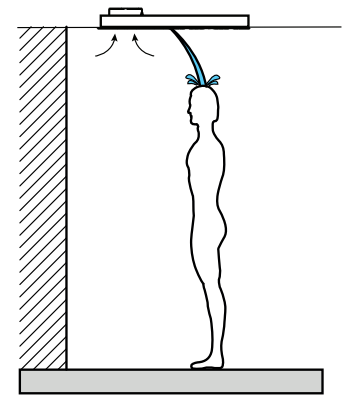
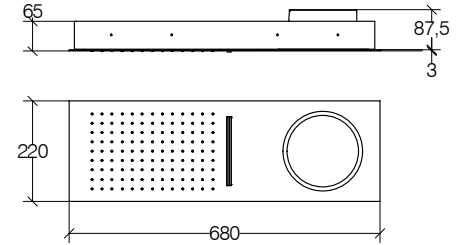
**Direzione della cascata**

Waterfall direction

Direction de la cascade

Wasserfallkaskadenrichtung

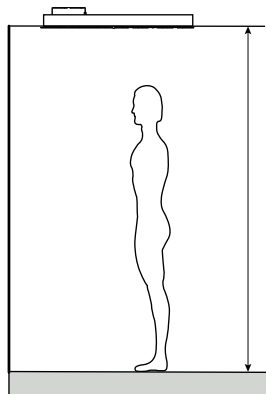
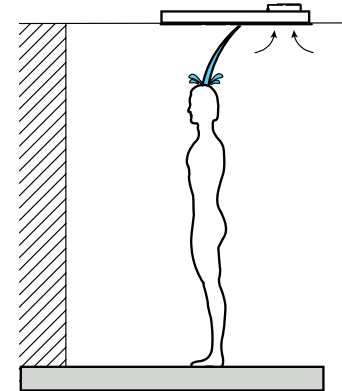
**Altezza massima raccomandata 230 cm.**

Maximum recommended height 230 cm.

Hauteur maximale recommandée 230 cm.

Maximal empfohlene Höhe 230 cm.

Acciaio inox lucido

Polished stainless steel

Acier inoxydable brillant

Poliert Edelstahl

CARATTERISTICHE IDRAULICHE

Hydraulic features _ Caractéristiques hydrologiques - Hydraulische Merkmale

PORTATA

Water flow _ Débit d'eau _ Wasserdurchfluss

7,11 ÷ 8,96L/min

PRESSIONE RETE

Network pressure _ Pression du réseau _ Druck im Netz

Min 1 ÷ 5 Max bar



53887

.29

€

910,00

SUPIONI

Soffione a soffitto tondo Ø 380 mm

Built-in round Ø 380 mm shower head / Pomme de douche de plafond ronde Ø 380 mm / Kopfbrause runde am Decken Ø 380 mm

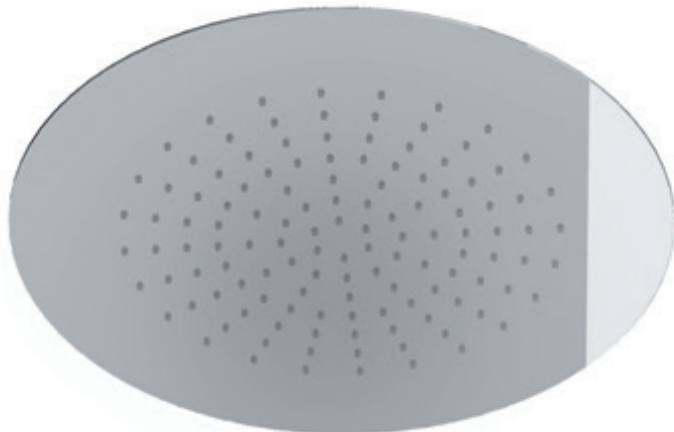
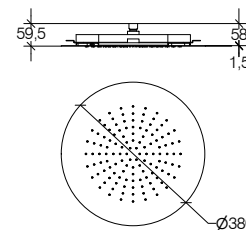

Acciaio inox lucido
Polished stainless steel
Acier inoxydable brillant
Poliert Edelstahl



CARATTERISTICHE IDRAULICHE

Hydraulic features _ Caractéristiques hydrologiques - Hydraulische Merkmale

| PORTATA | PRESSIONE RETE |
|---|---|
| Water flow _ Débit d'eau _ Wasserdurchfluss | Network pressure _ Pression du réseau _ Druck im Netz |
| 20,52 ÷ 39,70L/min | Min 1 ÷ 5 Max bar |



53883

.29

€

343,00

Soffione a soffitto tondo Ø 530 mm

Built-in round Ø 530 mm shower head / Pomme de douche de plafond ronde Ø 530 mm / Kopfbrause runde am Decken Ø 530 mm

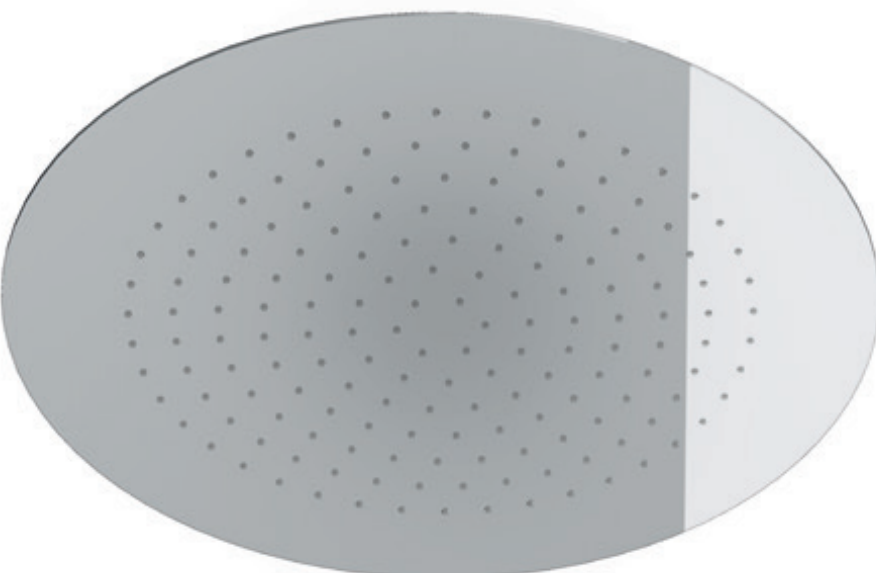
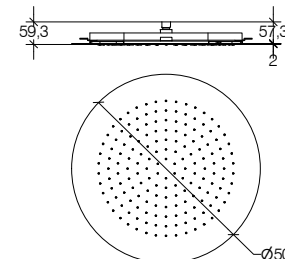

Acciaio inox lucido
Polished stainless steel
Acier inoxydable brillant
Poliert Edelstahl



CARATTERISTICHE IDRAULICHE

Hydraulic features _ Caractéristiques hydrologiques - Hydraulische Merkmale

| PORTATA | PRESSIONE RETE |
|---|---|
| Water flow _ Débit d'eau _ Wasserdurchfluss | Network pressure _ Pression du réseau _ Druck im Netz |
| 20,36 ÷ 39,11L/min | Min 1 ÷ 5 Max bar |



53884

.29

€

630,00

Soffione a soffitto quadro 350 x 350 mm solo pioggia

Built-in square 350 x 350 mm shower head / Pomme de douche de plafond carrée 350 x 350 mm / Kopfbrause quadratisch am Decken 350 x 350 mm

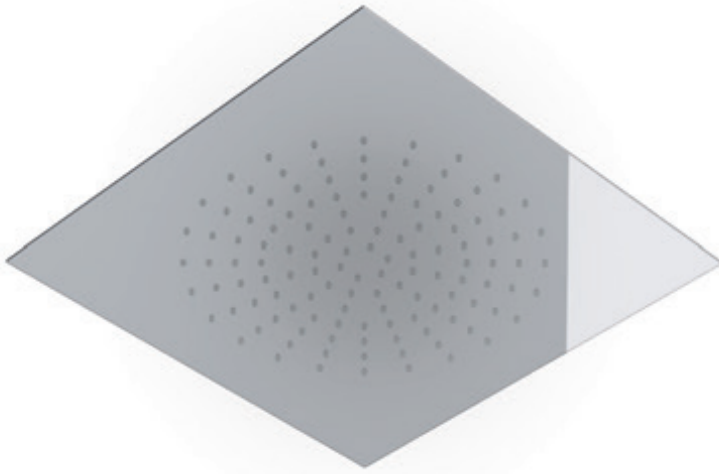
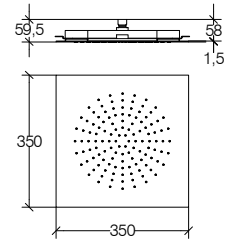

Acciaio inox lucido
Polished stainless steel
Acier inoxydable brillant
Poliert Edelstahl



| CARATTERISTICHE IDRAULICHE Hydraulic features _ Caractéristiques hydrologiques - Hydraulische Merkmale | |
|--|--|
| PORTATA Water flow _ Débit d'eau _ Wasserdurchfluss | PRESSIONE RETE Network pressure _ Pression du réseau _ Druck im Netz |
| 20,30 ÷ 39,07L/min | Min 1 ÷ 5 Max bar |



| | |
|--------------|------------|
| 53885 | .29 |
| € | 343,00 |

Soffione a soffitto quadro 500 x 500 mm solo pioggia

Built-in square 500 x 500 mm shower head, rain / Pomme de douche de plafond carrée 500 x 500 mm pluie / Kopfbrause quadratisch am Decken 500 x 500 mm nur Regen

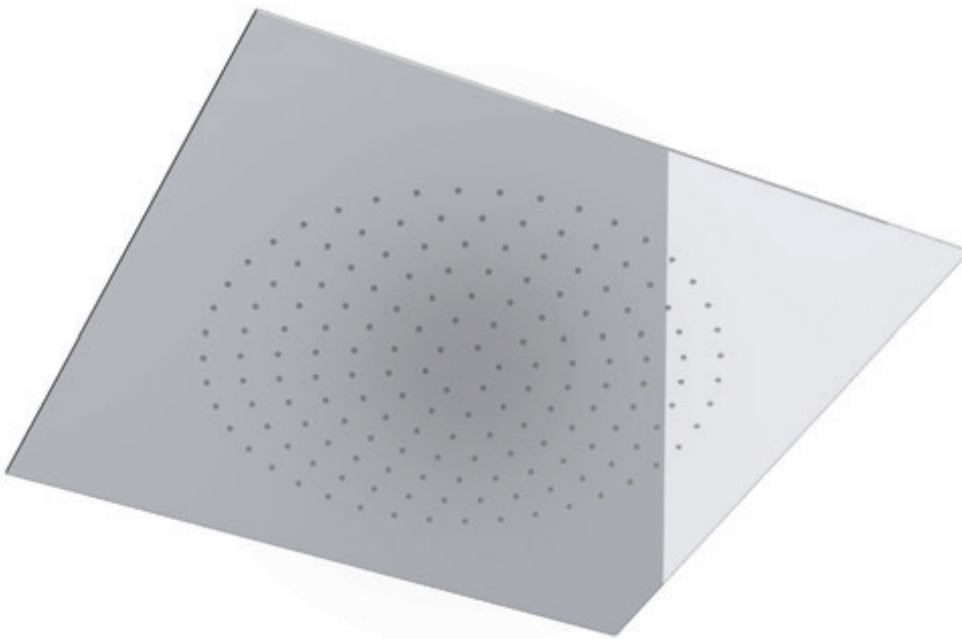
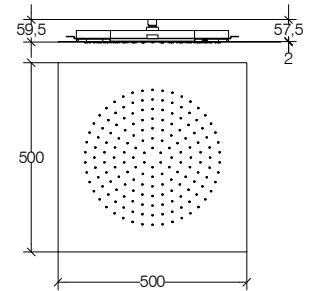

Acciaio inox lucido
Polished stainless steel
Acier inoxydable brillant
Poliert Edelstahl



| CARATTERISTICHE IDRAULICHE Hydraulic features _ Caractéristiques hydrologiques - Hydraulische Merkmale | |
|--|--|
| PORTATA Water flow _ Débit d'eau _ Wasserdurchfluss | PRESSIONE RETE Network pressure _ Pression du réseau _ Druck im Netz |
| 20,48 ÷ 39,80L/min | Min 1 ÷ 5 Max bar |



| | |
|--------------|------------|
| 53886 | .29 |
| € | 744,00 |

SUPIONI

Soffione doccia ispezionabile con snodo 1/2"

Self-cleaning shower head, with 1/2" connection

Pomme de douche autonettoyante avec raccord 1/2"

Selbstreinigender Kopfbräuse mit Kugelgelenk G 1/2"

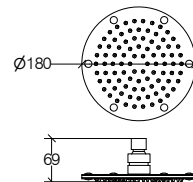

53810

Ottone cromato
Chromed brass
Laiton chromé
Verchromtes Messing



.29

€

107,00

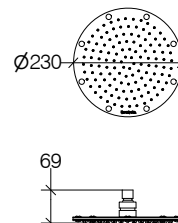

53811

Ottone cromato
Chromed brass
Laiton chromé
Verchromtes Messing



.29

€

183,00

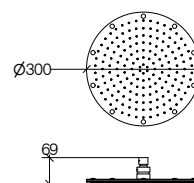

53812

Ottone cromato
Chromed brass
Laiton chromé
Verchromtes Messing



.29

€

274,00

CARATTERISTICHE IDRAULICHE

Hydraulic features _ Caractéristiques hydrologiques - Hydraulische Merkmale

PORTATA

Water flow _ Débit d'eau _ Wasserdurchfluss

8,50 ÷ 9,10L/min

PRESSIONE RETE

Network pressure _ Pression du réseau _ Druck im Netz

Min 1 ÷ 5 Max bar



Soffione doccia ispezionabile con snodo 1/2"

Self-cleaning shower head, with 1/2" connection

Pomme de douche autonettoyante avec raccord 1/2"

Selbstreinigender Kopfbräuse mit Kugelgelenk G 1/2"

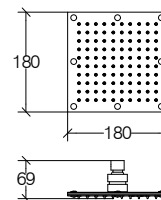

53815

Ottone cromato
Chromed brass
Laiton chromé
Verchromtes Messing



.29

€

120,00

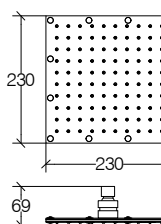

53816

Ottone cromato
Chromed brass
Laiton chromé
Verchromtes Messing

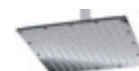

.29

€

190,00

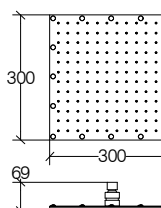

53817

Ottone cromato
Chromed brass
Laiton chromé
Verchromtes Messing

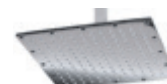

.29

€

306,00

CARATTERISTICHE IDRAULICHE

Hydraulic features _ Caractéristiques hydrologiques - Hydraulische Merkmale

PORTATA

Water flow _ Débit d'eau _ Wasserdurchfluss

8,20 ÷ 9,20L/min

PRESSIONE RETE

Network pressure _ Pression du réseau _ Druck im Netz

Min 1 ÷ 5 Max bar



Soffione doccia tondo piatto con snodo 1/2"

Round flat shower head, with 1/2" connection
 Pomme de douche ronde plate avec raccord 1/2"
 Duschkopf flach rund mit Kugelgelenk G 1/2"

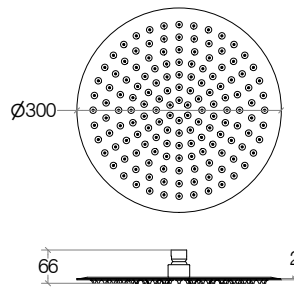
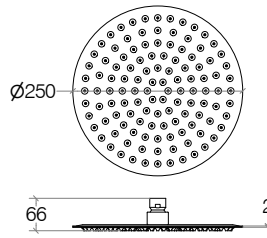
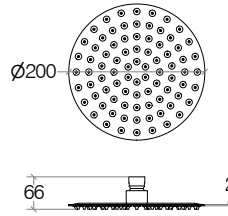
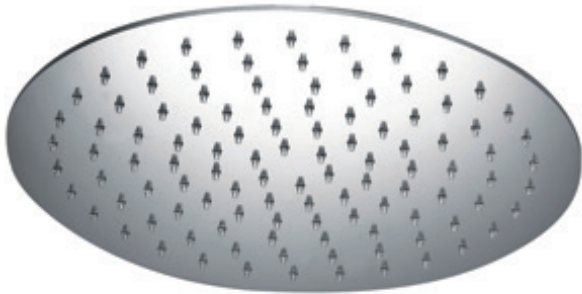

Acciaio inox lucido
 Polished stainless steel
 Acier inoxydable brillant
 Poliert Edelstahl



53840

.29

€

109,00

Acciaio inox lucido
 Polished stainless steel
 Acier inoxydable brillant
 Poliert Edelstahl



53841

.29

€

150,00

Acciaio inox verniciato
 Painted stainless steel
 Acier inoxydable verni
 Lackiertem Edelstahl



.23

164,00



53842

.29

€

162,00

Acciaio inox lucido
 Polished stainless steel
 Acier inoxydable brillant
 Poliert Edelstahl



AISI 304

CARATTERISTICHE IDRAULICHE

Hydraulic features _ Caractéristiques hydrologiques - Hydraulische Merkmale

| PORTATA Water flow _ Débit d'eau _ Wasserdurchfluss | PRESSIONE RETE Network pressure _ Pression du réseau _ Druck im Netz |
|--|---|
| 8,00 ÷ 9,40L/min | Min 1 ÷ 5 Max bar |

Soffione doccia quadro piatto con snodo 1/2"

Square flat shower head, with 1/2" connection
 Pomme de douche carrée plate avec raccord 1/2"
 Duschkopf flach quadratisch mit Kugelgelenk G 1/2"

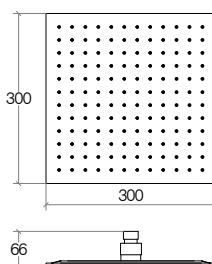
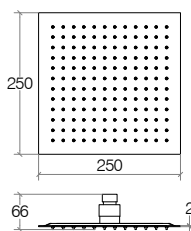
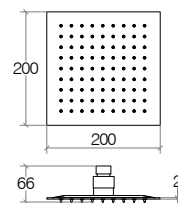
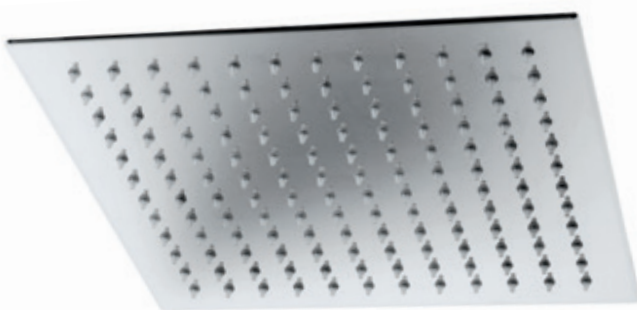

Acciaio inox lucido
 Polished stainless steel
 Acier inoxydable brillant
 Poliert Edelstahl



53834

.29

€

115,00

Acciaio inox lucido
 Polished stainless steel
 Acier inoxydable brillant
 Poliert Edelstahl



53835

.29

€

155,00

Acciaio inox verniciato
 Painted stainless steel
 Acier inoxydable verni
 Lackiertem Edelstahl



.23

171,00



53836

.29

€

169,00

Acciaio inox lucido
 Polished stainless steel
 Acier inoxydable brillant
 Poliert Edelstahl



AISI 304

CARATTERISTICHE IDRAULICHE

Hydraulic features _ Caractéristiques hydrologiques - Hydraulische Merkmale

| PORTATA Water flow _ Débit d'eau _ Wasserdurchfluss | PRESSIONE RETE Network pressure _ Pression du réseau _ Druck im Netz |
|--|---|
| 7,50 ÷ 9,40L/min | Min 1 ÷ 5 Max bar |

SUPIONI

Soffione doccia rettangolare piatto con snodo 1/2"

Rectangular flat shower head, with 1/2" connection
 Pomme de douche rectangulaire plate, avec raccord 1/2"
 Duschkopf flach rechteckiger mit Kugelgelenk G 1/2"

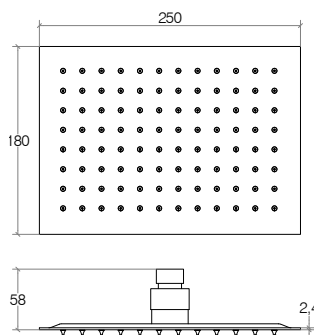

AISI 304

CARATTERISTICHE IDRAULICHE

Hydraulic features _ Caractéristiques hydrologiques - Hydraulische Merkmale

| PORTATA Water flow _ Débit d'eau _ Wasserdurchfluss | PRESSIONE RETE Network pressure _ Pression du réseau _ Druck im Netz |
|--|---|
| 8,20 ÷ 9,10L/min | Min 1 ÷ 5 Max bar |



Acciaio inox lucido
 Polished stainless steel
 Acier inoxydable brillant
 Poliert Edelstahl



53839

.29

€

142,00

Soffione doccia rettangolare piatto con attacco 1/2"

Rectangular flat shower head, with 1/2" connection
 Pomme de douche rectangulaire plate avec raccord 1/2"
 Duschkopf flach rechteckiger mit Kugelgelenk G 1/2"



AISI 304

CARATTERISTICHE IDRAULICHE

Hydraulic features _ Caractéristiques hydrologiques - Hydraulische Merkmale

| PORTATA Water flow _ Débit d'eau _ Wasserdurchfluss | PRESSIONE RETE Network pressure _ Pression du réseau _ Druck im Netz |
|--|---|
| 7,40 ÷ 8,90L/min | Min 1 ÷ 5 Max bar |

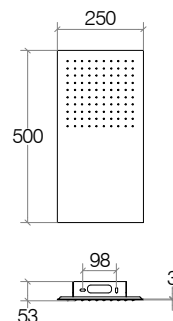

Acciaio inox lucido
 Polished stainless steel
 Acier inoxydable brillant
 Poliert Edelstahl



53860

.29

€

383,00

Soffione doccia rettangolare piatto con attacco 1/2"

Rectangular flat shower head, with 1/2" connection
 Pomme de douche rectangulaire plate avec raccord 1/2"
 Duschkopf flach rechteckiger mit Kugelgelenk G 1/2"



AISI 304

CARATTERISTICHE IDRAULICHE

Hydraulic features _ Caractéristiques hydrologiques - Hydraulische Merkmale

| PORTATA Water flow _ Débit d'eau _ Wasserdurchfluss | PRESSIONE RETE Network pressure _ Pression du réseau _ Druck im Netz |
|--|---|
| 6,40 ÷ 9,50L/min | Min 1 ÷ 5 Max bar |

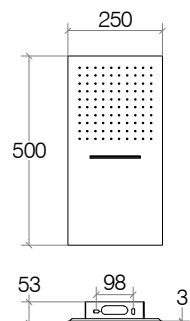

Acciaio inox lucido
 Polished stainless steel
 Acier inoxydable brillant
 Poliert Edelstahl



53861

.29

€

383,00

Soffione doccia tondo spessorato 7 mm con snodo 1/2"

Thickened round shower head 7 mm, with 1/2" connection
 Pomme de douche ronde épaisseur 7 mm, avec raccord 1/2"
 Duschkopf rund Dicke 7 mm mit Kugelgelenk G 1/2"



AISI
304

CARATTERISTICHE IDRAULICHE

Hydraulic features _ Caractéristiques hydrologiques - Hydraulische Merkmale

PORTATA

Water flow _ Débit d'eau _ Wasserdurchfluss

8,00 ÷ 9,20L/min

PRESSIONE RETE

Network pressure _ Pression du réseau _ Druck im Netz

Min 1 ÷ 5 Max bar

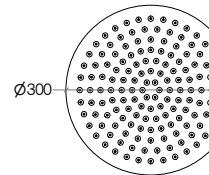
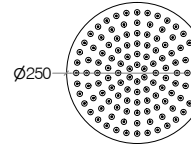
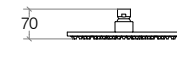
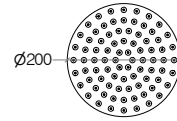
**Acciaio inox lucido**

Polished stainless steel
 Acier inoxydable brillant
 Poliert Edelstahl



53870

.29

€

109,00

Acciaio inox lucido

Polished stainless steel
 Acier inoxydable brillant
 Poliert Edelstahl



53871

.29

€

150,00

Acciaio inox lucido

Polished stainless steel
 Acier inoxydable brillant
 Poliert Edelstahl



53872

.29

€

162,00

Soffione doccia quadro spessorato 7 mm con snodo 1/2"

Thickened square shower head 7 mm, with 1/2" connection
 Pomme de douche carrée épaisseur 7 mm, avec raccord 1/2"
 Duschkopf quadratisch Dicke 7 mm mit Kugelgelenk G 1/2"



AISI
304

CARATTERISTICHE IDRAULICHE

Hydraulic features _ Caractéristiques hydrologiques - Hydraulische Merkmale

PORTATA

Water flow _ Débit d'eau _ Wasserdurchfluss

8,20 ÷ 9,30L/min

PRESSIONE RETE

Network pressure _ Pression du réseau _ Druck im Netz

Min 1 ÷ 5 Max bar

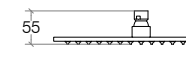
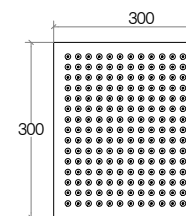
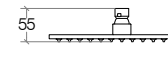
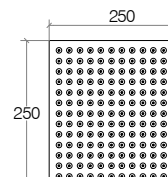
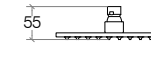
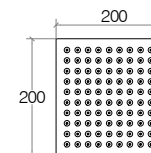
**Acciaio inox lucido**

Polished stainless steel
 Acier inoxydable brillant
 Poliert Edelstahl



53880

.29

€

115,00

Acciaio inox lucido

Polished stainless steel
 Acier inoxydable brillant
 Poliert Edelstahl



53881

.29

€

155,00

Acciaio inox lucido

Polished stainless steel
 Acier inoxydable brillant
 Poliert Edelstahl



53882

.29

€

169,00

SUPIONI

Braccio doccia tondo a parete per snodo 1/2"

Wall round shower-arm, 1/2" joint
 Bras de douche mural, rond, raccord 1/2"
 Brausearm, Wandmontage G 1/2" rund

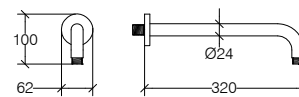

Ottone cromato
 Chromed brass
 Laiton chromé
 Verchromtes Messing



Ottone verniciato
 Painted brass
 Laiton verni
 Lackiertem Messing



| | | |
|--------------|------------|------------|
| 53801 | .29 | .23 |
| € | 51,00 | 57,00 |

Braccio doccia tondo a parete per snodo 1/2"

Wall round shower-arm, 1/2" joint
 Bras de douche mural, rond, raccord 1/2"
 Brausearm, Wandmontage G 1/2" rund

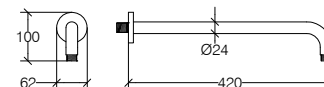

Ottone cromato
 Chromed brass
 Laiton chromé
 Verchromtes Messing



Ottone verniciato
 Painted brass
 Laiton verni
 Lackiertem Messing



| | | |
|--------------|------------|------------|
| 53802 | .29 | .23 |
| € | 57,00 | 62,00 |

Rinforzo per braccio tondo

Round sure grip shower-arm flange
 Bras de douche mural, rond, raccord 1/2"
 Verstärkung für Brausearm rund

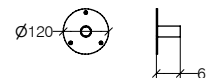

Ottone cromato
 Chromed brass
 Laiton chromé
 Verchromtes Messing



Ottone verniciato
 Painted brass
 Laiton verni
 Lackiertem Messing



| | | |
|---------------|------------|------------|
| 53802R | .29 | .23 |
| € | 57,00 | 62,00 |

Rinforzo per braccio doccia quadro a parete per snodo 1/2"

Square sure grip shower-arm flange 1/2" joint
 Plaque de support pour bras de douche carré raccord 1/2"
 Verstärkung für Brausearm quadratisch Wandmontage G 1/2"

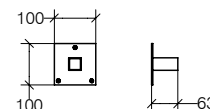

Ottone cromato
 Chromed brass
 Laiton chromé
 Verchromtes Messing



Ottone verniciato
 Painted brass
 Laiton verni
 Lackiertem Messing



| | | |
|---------------|------------|------------|
| 53807R | .29 | .23 |
| € | 60,00 | 67,00 |

Braccio doccia quadro a parete per snodo 1/2"

Wall square shower-arm, 1/2" joint
 Bras de douche mural, carré, raccord 1/2"
 Brausearm , Wandmontage G 1/2" quadratisch

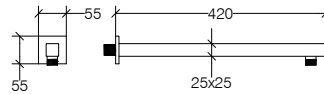
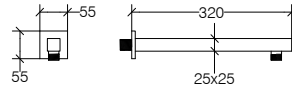

Ottone cromato
 Chromed brass
 Laiton chromé
 Verchromtes Messing

Ottone verniciato
 Painted brass
 Laiton verni
 Lackiertem Messing



| | | |
|--------------|------------|------------|
| 53806 | .29 | .23 |
| € | 60,00 | 67,00 |
| 53807 | .29 | .23 |
| € | 79,00 | 87,00 |

Braccio doccia a soffitto tondo per snodo 1/2"

Ceiling round shower-arm, 1/2" joint
 Bras de douche de plafond, rond, raccord 1/2"
 Brausearm , Deckenmontage G 1/2" rund

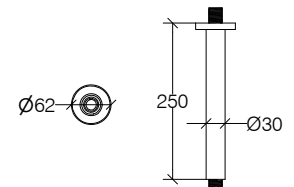

Ottone cromato
 Chromed brass
 Laiton chromé
 Verchromtes Messing

| | |
|--------------|------------|
| 53804 | .29 |
| € | 54,00 |

Braccio doccia a soffitto quadro per snodo 1/2"

Ceiling square shower-arm, 1/2" joint
 Bras de douche de plafond, carré, raccord 1/2"
 Brausearm Deckenmontage G 1/2" quadratisch

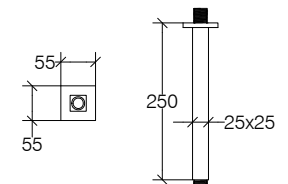

Ottone cromato
 Chromed brass
 Laiton chromé
 Verchromtes Messing

| | |
|--------------|------------|
| 53808 | .29 |
| € | 52,00 |

DOCCIA

Doccetta quadrata piatta

Square flat hand shower / Douchette plate carrée / Quadratische Fläche Handbrause

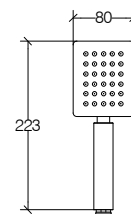

| CARATTERISICHE IDRAULICHE Hydraulic features _ Caractéristiques hydrologiques - Hydraulische Merkmale | |
|---|--|
| PORTATA Water flow _ Débit d'eau _ Wasserdurchfluss | PRESSIONE RETE Network pressure _ Pression du réseau _ Druck im Netz |
| 7,11 ÷ 9,00L/min | Min 1 ÷ 5 Max bar |

Ottone cromato
Chromed brass
Laiton chromé
Verchromtes Messing

Ottone verniciato
Painted brass
Laiton verni
Lackiertem Messing



| | | |
|---------------|------------|------------|
| 541725 | .29 | .23 |
| € | 60,00 | 92,00 |

Doccetta tonda piatta

Round flat hand shower / Douchette plate ronde / Handbrause Runde flache

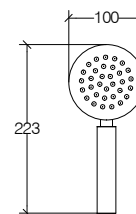

| CARATTERISICHE IDRAULICHE Hydraulic features _ Caractéristiques hydrologiques - Hydraulische Merkmale | |
|---|--|
| PORTATA Water flow _ Débit d'eau _ Wasserdurchfluss | PRESSIONE RETE Network pressure _ Pression du réseau _ Druck im Netz |
| 7,11 ÷ 9,00L/min | Min 1 ÷ 5 Max bar |

Ottone cromato
Chromed brass
Laiton chromé
Verchromtes Messing

Ottone verniciato
Painted brass
Laiton verni
Lackiertem Messing



| | | |
|---------------|------------|------------|
| 541726 | .29 | .23 |
| € | 60,00 | 83,00 |

Doccetta

Hand shower / Douchette / Handbrause

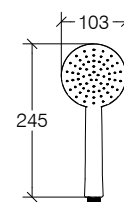

| CARATTERISICHE IDRAULICHE Hydraulic features _ Caractéristiques hydrologiques - Hydraulische Merkmale | |
|---|--|
| PORTATA Water flow _ Débit d'eau _ Wasserdurchfluss | PRESSIONE RETE Network pressure _ Pression du réseau _ Druck im Netz |
| 8,59 ÷ 16,47L/min | Min 1 ÷ 5 Max bar |

ABS cromato
Chromed ABS
ABS chromé
Verchromtes ABS



| | |
|---------------|---------------|
| 541723 | .29.09 |
| € | 25,00 |

DOCCIA

Doccetta quadrata

Square hand shower / Douchette carrée / Handbrause quadratisch

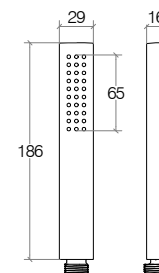

ABS cromato
Chromed ABS
ABS chromé
Verchromtes ABS

**CARATTERISICHE IDRAULICHE**

Hydraulic features _ Caractéristiques hydrologiques - Hydraulische Merkmale

| PORTATA | PRESSIONE RETE |
|---|---|
| Water flow _ Débit d'eau _ Wasserdurchfluss | Network pressure _ Pression du réseau _ Druck im Netz |
| 7,40 ÷ 16,60L/min | Min 1 ÷ 5 Max bar |

541712

.29

€

23,00

Doccetta cilindrica

Round hand shower / Douchette cylindrique / Handbrause rund

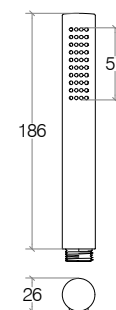

ABS cromato
Chromed ABS
ABS chromé
Verchromtes ABS

**CARATTERISICHE IDRAULICHE**

Hydraulic features _ Caractéristiques hydrologiques - Hydraulische Merkmale

| PORTATA | PRESSIONE RETE |
|---|---|
| Water flow _ Débit d'eau _ Wasserdurchfluss | Network pressure _ Pression du réseau _ Druck im Netz |
| 9,70 ÷ 21,80L/min | Min 1 ÷ 5 Max bar |

541713

.29

€

20,00

Doccetta, 3 getti regolabili

Hand shower with 3 jets / Douchette massage avec 3 jets / Handbrause 3 Strahlarten

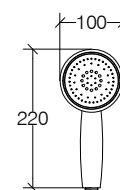

ABS cromato
Chromed ABS
ABS chromé
Verchromtes ABS

**CARATTERISICHE IDRAULICHE**

Hydraulic features _ Caractéristiques hydrologiques - Hydraulische Merkmale

| PORTATA | PRESSIONE RETE |
|---|---|
| Water flow _ Débit d'eau _ Wasserdurchfluss | Network pressure _ Pression du réseau _ Druck im Netz |
| 8,96 ÷ 18,60L/min | Min 1 ÷ 5 Max bar |

541721

.29

€

28,00

DOCCIA

Flessibile doppia maglia 1500 mm, con attacco conico da 1/2"

Double seam flexible hose 1500 mm, with 1/2" connection / Flexible 1500 mm, raccord G 1/2" / Brausenschlauch 1500 mm, konische Mutter G 1/2"

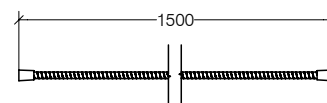

Ottone cromato
Chromed brass
Laiton chromé
Verchromtes Messing



| | |
|---------------|------------|
| 541701 | .29 |
| € | 26,00 |

Flessibile PVC 1500 mm, con attacco conico da 1/2"

PVC flexible hose 1500 mm, with 1/2" connection / Flexible PVC 1500 mm, raccord G 1/2" / Brausenschlauch aus PVC 1500 mm, konische Mutter G 1/2"

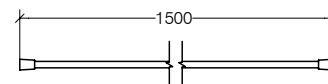

PVC argento
Silver PVC
PVC argent
Silber PVC

PVC nero
Black PVC
PVC noir
PVC Schwarz



| | | |
|---------------|------------|------------|
| 541702 | .29 | .23 |
| € | 26,00 | 36,00 |

Supporto a muro per doccia

Hand shower support / Support pour douchette / Wandhalter für Handbrause

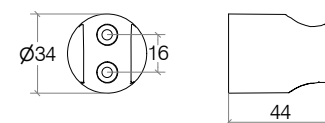

ABS cromato
Chromed ABS
ABS chromé
Verchromtes ABS

ABS nero
Black ABS
ABS noir
ABS Schwarz



| | | |
|---------------|------------|------------|
| 541714 | .29 | .23 |
| € | 16,00 | 18,00 |



DOCCIA

Colonna doccia con deviatore, flessibile, doccetta cilindrica, altezza regolabile

Equipped shower column with diverter and hose, hand shower, adjustable height

Colonne de douche avec inverseur, flexible, douchette, hauteur réglable

Brausestange mit Umsteller, Schlauch, Handbrause und höhenverstellbar

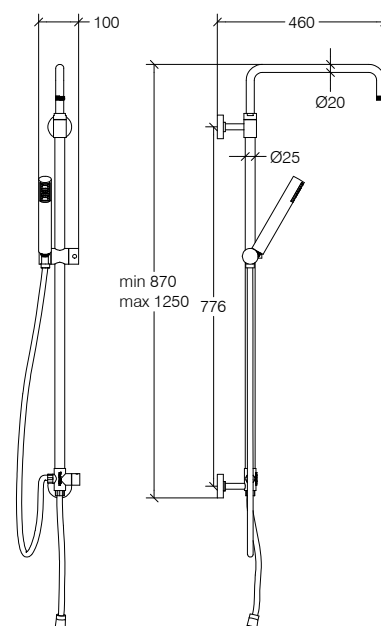

Ottone cromato
Chromed brass
Laiton chromé
Verchromtes Messing



54180

.29

€

395,00

DOCCIA

Asta saliscendi tubo tondo

Round sliding rail / Barre de douche ronde / Runde Brausestange

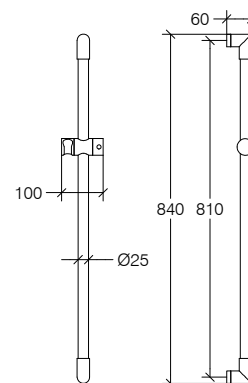

Ottone cromato
Chromed brass
Laiton chromé
Verchromtes Messing



54174

.29

€

175,00

Asta saliscendi tubo rettangolare

Square sliding rail / Barre de douche rectangulaire / Rechteckige Brausestange

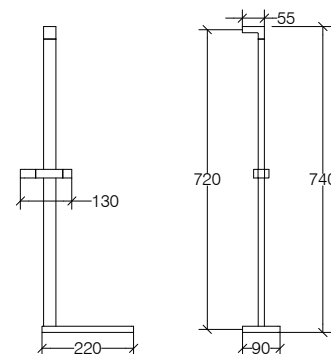

ABS cromato
Chromed ABS
ABS chromé
Verchromtes ABS



54175

.29

€

76,00

DOCCIA

Puliscivetro in silicone

Silicon glass wiper / Raclette de douche en silicone / Scheibenwischer aus Silikon

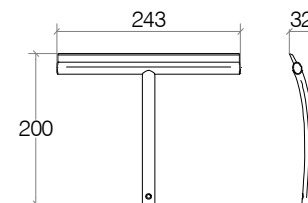

Silicone
Silicon
Silicone
Silikon



53288

.17

€

39,00

Puliscivetro per parete e pavimento

Adjustable glass wiper 1 mt / wall and floor / Raclette de douche 1 mt démontable / Scheibenwischer für Wand und Boden

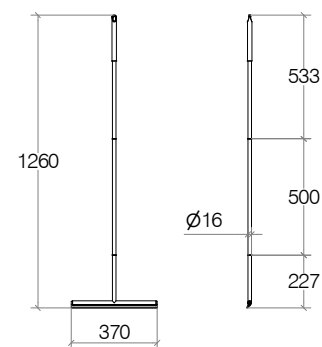

Acciaio inox/silicone
Stainless steel/silicon
Acier inoxydable/silicone
Edelstahl/Silikon



53289

.29

€

98,00

Puliscivetro acciaio/silicone

Glass wiper / stainless steel / silicon / Raclette de douche, acier et silicone / Scheibenwischer

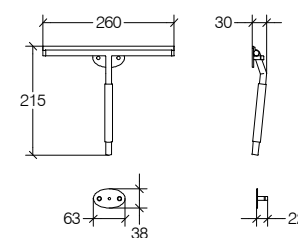

Acciaio inox/silicone
Stainless steel/silicon
Acier inoxydable/silicone
Edelstahl/Silikon



53290

.17

€

48,00

DOCCIA

Kit take away

Kit take away / Kit à emporter / Bausatz zum Mitnehmen



541702.29 Flessibile PVC 1500 mm, con attacco conico da 1/2"

PVC flexible hose 1500 mm, with 1/2" connection
Flexible PVC 1500 mm, raccord G 1/2"
Brausenschlauch aus PVC 1500 mm, konische Mutter G 1/2"

54198.29 Presa acqua tonda con supporto doccetta

Round water outlet with shower hook
Sortie d'eau ronde avec crochet pour douchette
Wandanschlussbogen rund mit Brausehalterung

541713.29 Doccetta cilindrica cromo

Round hand shower chrome
Douchette cylindrique chrome
Handbrause rund Chrom

Ottone cromato
Chromed brass
Laiton chromé
Verchromtes Messing

ABS cromato
Chromed ABS
ABS chromé
Verchromtes ABS



TA-DOCCIA T

.29

€

89,00

Kit take away

Kit take away / Kit à emporter / Bausatz zum Mitnehmen



541702.29 Flessibile PVC 1500 mm, con attacco conico da 1/2"

PVC flexible hose 1500 mm, with 1/2" connection
Flexible PVC 1500 mm, raccord G 1/2"
Brausenschlauch aus PVC 1500 mm, konische Mutter G 1/2"

54199.29 Presa acqua quadra con supporto doccetta

Square water outlet with shower hook
Sortie d'eau carrée avec crochet pour douchette
Wandanschlussbogen quadratisch mit Brausehalterung
Wandanschlussbogen rund mit Brausehalterung

541712.29 Doccetta quadrata cromo

Square hand shower chrome
Douchette carrée chrome
Handbrause quadratisch Chrom

Ottone cromato
Chromed brass
Laiton chromé
Verchromtes Messing

ABS cromato
Chromed ABS
ABS chromé
Verchromtes ABS



TA-DOCCIA I

.29

€

97,00

DOCCIA

Kit take away

Kit take away / Kit à emporter / Bausatz zum Mitnehmen

**53801.29 Braccio doccia tondo a parete per snodo 1/2"**

Wall round shower-arm, 1/2" joint
 Bras de douche mural, rond, raccord 1/2"
 Brausearm , Wandmontage G 1/2" rund

541702.29 Flessibile PVC 1500 mm, con attacco conico da 1/2"

PVC flexible hose 1500 mm, with 1/2" connection
 Flexible PVC 1500 mm, raccord G 1/2"
 Brausenschlauch aus PVC 1500 mm, konische Mutter G 1/2"

54198.29 Presa acqua tonda con supporto doccetta

Round water outlet with shower hook
 Sortie d'eau ronde avec crochet pour douchette
 Wandanschlussbogen rund mit Brausehalterung

541713.29 Doccetta cilindrica cromo

Round hand shower chrome
 Douchette cylindrique chrome
 Handbrause rund Chrom

53841.29 Sofflone doccia tondo piatto con snodo 1/2"

Round flat shower head, with 1/2" connection
 Pomme de douche ronde plate avec raccord 1/2"
 Duschkopf flach rund mit Kugelgelenk G 1/2"

Ottone cromato
 Chromed brass
 Laiton chromé
 Verchromtes Messing

ABS cromato
 Chromed ABS
 ABS chromé
 Verchromtes ABS



TA-DOCCIATMAXI2

.29

€

266,00

Kit take away

Kit take away / Kit à emporter / Bausatz zum Mitnehmen

**53806.29 Braccio doccia quadro a parete per snodo 1/2"**

Wall square shower-arm, 1/2" joint
 Bras de douche mural, carré, raccord 1/2"
 Brausearm , Wandmontage G 1/2" quadratisch

541702.29 Flessibile PVC 1500 mm, con attacco conico da 1/2"

PVC flexible hose 1500 mm, with 1/2" connection
 Flexible PVC 1500 mm, raccord G 1/2"
 Brausenschlauch aus PVC 1500 mm, konische Mutter G 1/2"

54199.29 Presa acqua quadra con supporto doccetta

Square water outlet with shower hook
 Sortie d'eau carrée avec crochet pour douchette
 Wandanschlussbogen quadratisch mit Brausehalterung
 Wandanschlussbogen rund mit Brausehalterung

541712.29 Doccetta quadrata cromo

Square hand shower chrome
 Douchette carrée chrome
 Handbrause quadratisch Chrom

53835.29 Sofflone doccia quadro piatto con snodo 1/2"

Square flat shower head, with 1/2" connection
 Pomme de douche carrée plate avec raccord 1/2"
 Duschkopf flach quadratisch mit Kugelgelenk G 1/2"

Ottone cromato
 Chromed brass
 Laiton chromé
 Verchromtes Messing

ABS cromato
 Chromed ABS
 ABS chromé
 Verchromtes ABS



TA-DOCCIAQMAXII

.29

€

283,00

DOCCIA

Tenda doccia waterproof

Waterproof shower curtain / Rideau de douche imperméable / Duschvorhang wasserdicht

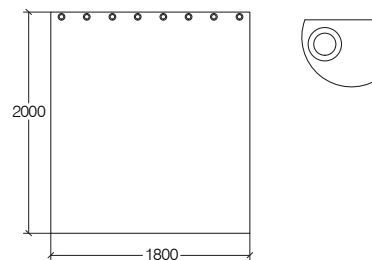

Poliestere
Polyester
Polyester
Polyester



Poliestere
Polyester
Polyester
Polyester



| | | |
|--------------|------------|------------|
| 71801 | .09 | .53 |
| € | 92,00 | 92,00 |

Tubo per doccia ad angolo (accorciabile)

Corner shower curtain holder (can be shortened) / Support angle pour rideau de douche (raccourcissable) / Eckige Halterung für Duschvorhang (verkürzbar)

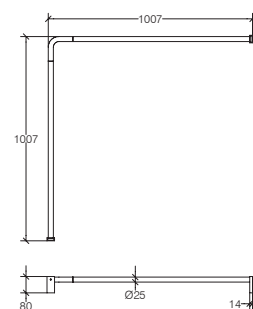

Ottone cromato
Chromed brass
Laiton chromé
Verchromtes Messing

| | |
|--------------|------------|
| 71804 | .29 |
| € | 198,00 |

Tubo per doccia dritto (accorciabile)

Straight shower curtain holder (can be shortened) / Support droit pour rideau de douche (raccourcissable) / Halterung für Duschvorhang (verkürzbar)

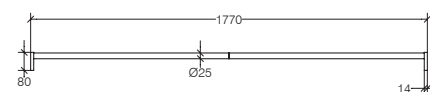

Ottone cromato
Chromed brass
Laiton chromé
Verchromtes Messing

| | |
|--------------|------------|
| 71805 | .29 |
| € | 185,00 |

Pedana doccia in multistrato marino

Marine plywood shower mat / Caillebotis douche en bois multicouche marin / Duschfußbrett aus marine Sperrholz

Legno Okumè
Okumè wood
Bois Okumè
Holz Okumè

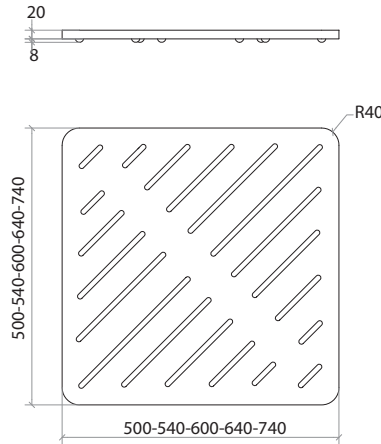

| | | |
|---------|--------------|------------|
| 500X500 | 7224 | .08 |
| | € | 115,00 |
| 540X540 | 7225 | .08 |
| | € | 127,00 |
| 600X600 | 7226 | .08 |
| | € | 149,00 |
| 640X640 | 7227 | .08 |
| | € | 167,00 |
| 740X740 | 72271 | .08 |
| | € | 190,00 |



Pedana doccia in multistrato marino

Marine plywood shower mat / Caillebotis douche en bois multicouche marin / Duschfußbrett aus marine Sperrholz

Legno Okumè
Okumè wood
Bois Okumè
Holz Okumè

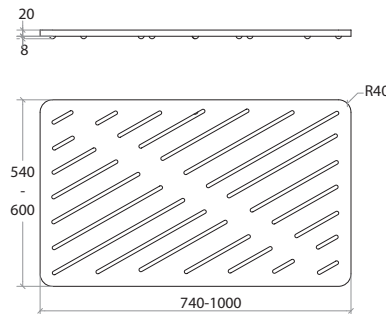

| | | |
|----------|-------------|------------|
| 600X1000 | 7228 | .08 |
| | € | 158,00 |
| 600X1000 | 7229 | .08 |
| | € | 221,00 |



Pedana doccia in multistrato marino

Marine plywood shower mat / Caillebotis douche en bois multicouche marin / Duschfußbrett aus marine Sperrholz

Legno Okumè
Okumè wood
Bois Okumè
Holz Okumè

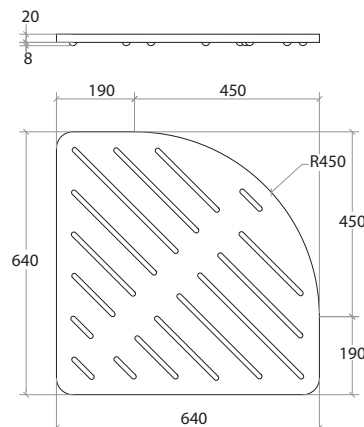

| | | |
|--|-------------|------------|
| | 7230 | .08 |
| | € | 158,00 |





Griglie e accessori doccia

Shower baskets and shower accessories / Paniers et accessoires douche / Duschkörbe und Duschezubehöre

FILO: dal latino 'filum', deriva da 'findere', cioè tagliare, dividere.

Oggetti indispensabili per contenere in maniera organizzata tutto ciò che è utile per la cura del corpo.

EN

FILO:

from the Latin 'filum'; it derives from 'findere', which means to cut, divide.

Essential objects to contain and organize all body care items.

FR

FILO :

du latin « filum », il dérive de « findere », c'est-à-dire couper, diviser.

Objets essentiels pour ranger de manière organisée tout ce qui peut être utile pour le soin du corps.

DE

FILO:

aus dem Lateinischen 'filum', abgeleitet von 'findere', also schneiden, trennen.

Unverzichtbare Objekte für die organisierte Aufbewahrung all dessen, was der Körperpflege dient.

Finiture _ Finishes _ Finitions _ Ausführung:

Alluminio verniciato bianco

White painted aluminium
Aluminium verni blanc
Lackierter Aluminium Weiß

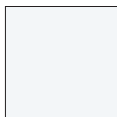

.09

ABS bianco

White ABS
ABS blanc
Weiß ABS



.09

Acciaio inox lucido

Polished stainless steel
Acier inoxydable brillant
Poliert Edelstahl



.29

Alluminio verniciato nero

Black painted aluminium
Aluminium verni noir
Lackierter Aluminium Schwarz



.23

ABS nero

Black ABS
ABS noir
ABS Schwarz



.23

Acciaio inox satinato

Satinated stainless steel
Acier inoxydable satiné
Vereist Edelstahl



.32

ABS cromato

Chromed ABS
ABS chromé
Verchromtes ABS



.29

Ottone cromato

Chromed brass
Laiton chromé
Verchromtes Messing



.29

FILO

Cestino doppio appendibile. Si adatta perfettamente a pareti doccia con o senza telaio. (telaio max 40 mm)

Removable double basket. Fits perfectly on framed or frameless shower walls. (max. frame 40 mm)

Double panier amovible. S'adapte parfaitement aux parois de douche avec ou sans cadre. (profilé max. 40 mm).

Abnehmbarer Doppelkorb. Passt perfekt auf gerahmte oder rahmenlose Duschwände. (max. Rahmen 40 mm).

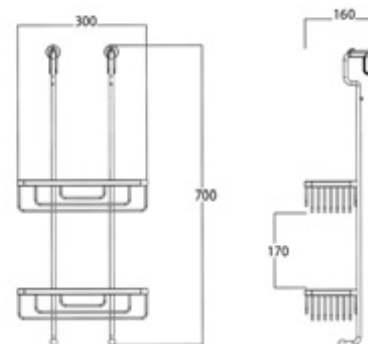

Verniciato bianco
Painted white
Laqué blanc
Lackiertem Weiß

Verniciato nero
Painted black
Laqué noir
Lackiertem Schwarz

Acciaio inox cromato
Chromed stainless steel
Acier inoxydable chromé
Verchromter Poliert Edelstahl



new

50028

.09

.23

.29

€

227,00

227,00

206,00



Griglia doccia doppia, da appendere

Hanging double shower basket / Panier douche double à accrocher / Duschablage zum Hängen 2-fach

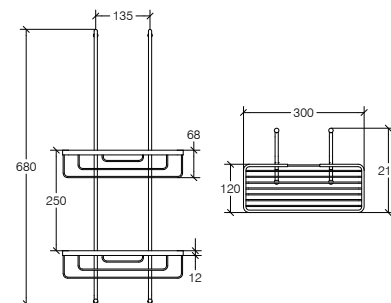

Acciaio inox cromato
Chromed stainless steel
Acier inoxydable chromé
Verchromter Poliert Edelstahl



50030

.29

€

176,00



Griglia doccia doppia, da appendere

Hanging double shower basket / Panier douche double à accrocher / Duschlage zum Hängen 2-fach

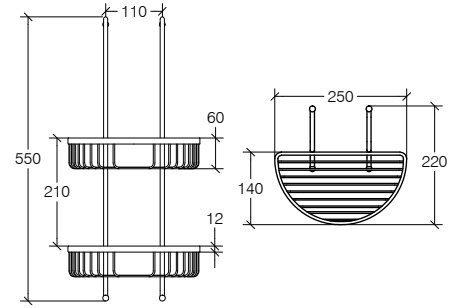

FILO

Acciaio inox cromato
Chromed stainless steel
Acier inoxydable chromé
Verchromter Poliert Edelstahl



| | |
|--------------|------------|
| 50031 | .29 |
| € | 164,00 |

Griglia doccia doppia, da appendere

Hanging double shower basket / Panier douche double à accrocher / Duschlage zum Hängen 2-fach

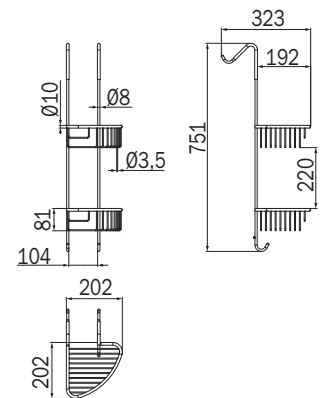

Ottone cromato
Chromed brass
Laiton chromé
Verchromtes Messing



| | |
|----------------|------------|
| 50029SX | .29 |
| 50029DX | .29 |
| € | 205,00 |

FILO

Griglia doccia angolare doppia

Corner shower basket, double / Panier douche double angulaire / Duschablage 2-fach

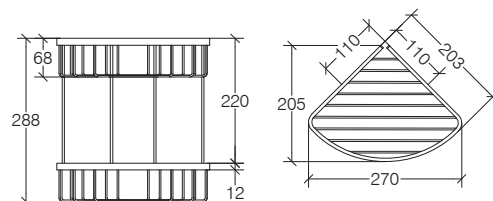

Acciaio inox cromato
Chromed stainless steel
Acier inoxydable chromé
Verchromter Poliert Edelstahl



50032

.29

€

132,00

Griglia doccia angolare tripla

Corner shower basket, triple / Panier douche triple angulaire / Duschablage 3-fach

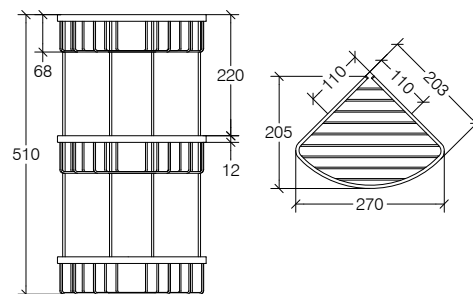

Acciaio inox cromato
Chromed stainless steel
Acier inoxydable chromé
Verchromter Poliert Edelstahl



50033

.29

€

185,00

Griglia doccia da appendere con ripiano e specchio regolabile

Shower basket with shelf and adjustable mirror / Panier douche avec tablette et miroir réglable / Seifenablage mit Ablage und verstellbarem Spiegel

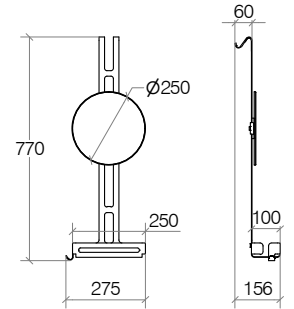
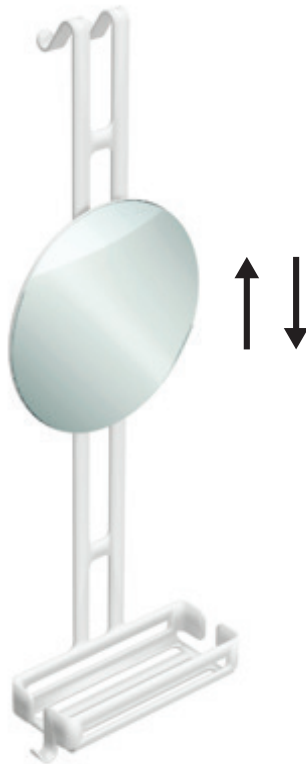

FILO

Alluminio verniciato Painted aluminium / Aluminium laqué / Lackiertem Aluminium
Alluminio verniciato Painted aluminium / Aluminium laqué / Lackiertem Aluminium



50036

.09

.23

€

304,00

304,00



Griglia doccia da appendere con due ripiani

Shower basket with two shelf / Panier douche deux étagères / Seifenablage mit zwei Ablagen

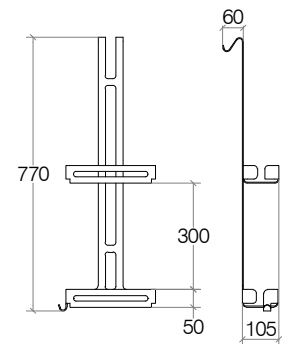

Alluminio verniciato Painted aluminium / Aluminium laqué / Lackiertem Aluminium
Alluminio verniciato Painted aluminium / Aluminium laqué / Lackiertem Aluminium



50037

.09

.23

€

197,00

197,00



FILO

Griglia doccia angolare

Corner shower basket / Panier douche angulaire / Seifenablage eckig

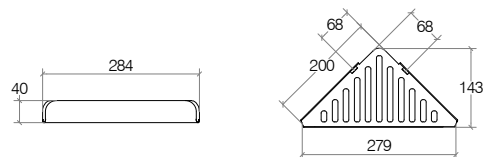

Verniciato bianco
Painted white
Blanc laqué
Lackiertem Weiß

Verniciato nero
Painted black
Noir laqué
Lackiertem Schwarz

Acciaio inox lucido
Polished stainless steel
Acier inoxydable brillant
Poliert Edelstahl

Acciaio inox satinato
Satinated stainless steel
Acier inoxydable satiné
Vereist Edelstahl

new

| | | | | |
|--------------|------------|------------|------------|------------|
| 50034 | .09 | .23 | .29 | .32 |
| € | 75,00 | 75,00 | 90,00 | 90,00 |



Artic
Artic
Artic
Artic



Sailor Blue
Sailor Blue
Sailor Blue
Sailor Blue



Grigio
Grey
Gris
Grau



Sabbia
Sand
Sable
Sand



Tortora
Tortora
Tortora
Tortora



Sage
Sage
Sage
Sage



Ambra
Ambra
Ambra
Ambra



50034

.90

.92

.95

.98

.99

.73

.86

€

75,00

75,00

75,00

75,00

75,00

75,00

75,00



Griglia doccia

Shower basket / Panier douche / Seifenablage

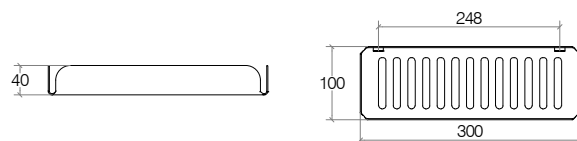
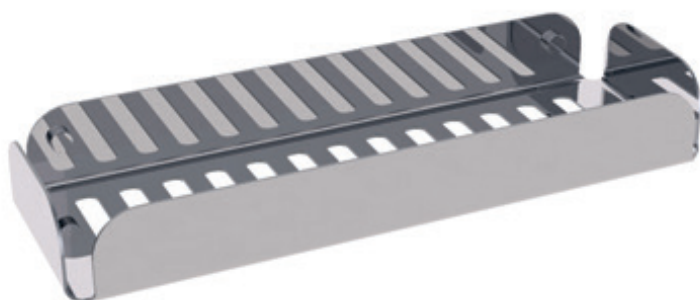

Verniciato bianco
Painted white
Blanc laqué
Lackiertem Weiß

Verniciato nero
Painted black
Noir laqué
Lackiertem Schwarz

Acciaio inox lucido
Polished stainless steel
Acier inoxydable brillant
Poliert Edelstahl

Acciaio inox satinato
Satinated stainless steel
Acier inoxydable satiné
Vereist Edelstahl

new

| | | | | |
|--------------|------------|------------|------------|------------|
| 50035 | .09 | .23 | .29 | .32 |
| € | 75,00 | 75,00 | 90,00 | 90,00 |



Artic
Artic
Artic
Artic



Sailor Blue
Sailor Blue
Sailor Blue
Sailor Blue



Grigio
Grey
Gris
Grau



Sabbia
Sand
Sable
Sand



Tortora
Tortora
Tortora
Tortora



Sage
Sage
Sage
Sage



Ambra
Ambra
Ambra
Ambra



50035

.90

.92

.95

.98

.99

.73

.86

€

75,00

75,00

75,00

75,00

75,00

75,00

75,00



Griglia doccia angolare

Corner shower basket / Panier douche angulaire / Seifenablage eckig

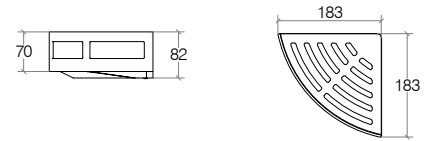

ABS cromato
Chromed ABS
ABS chromé
Verchromtes ABS



ABS nero
Black ABS
ABS noir
ABS Schwarz



| | | |
|--------------|------------|------------|
| 50040 | .29 | .23 |
| € | 68,00 | 78,00 |

Portaoggetti da doccia

Basket for shower / Panier douche porte-objets Schwammkorb für Dusche

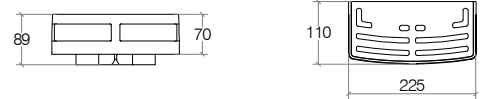
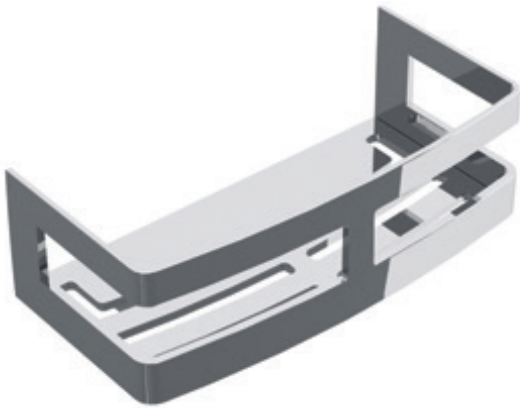

ABS cromato
Chromed ABS
ABS chromé
Verchromtes ABS



ABS nero
Black ABS
ABS noir
ABS Schwarz



| | | |
|--------------|------------|------------|
| 50039 | .29 | .23 |
| € | 75,00 | 87,00 |

Griglia doccia angolare sganciabile

Removable corner shower basket / Panier douche d'angle amovible / Abnehmbarer Seifenablage eckig

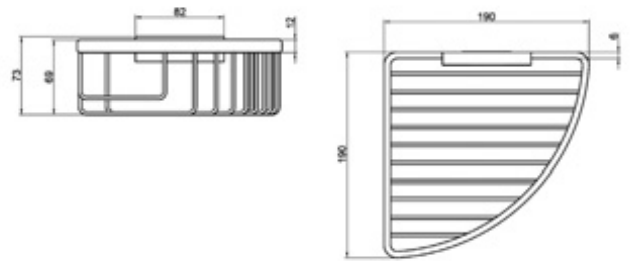

Acciaio inox cromato
Chromed stainless steel
Acier inoxydable chromé
Verchromter Poliert Edelstahl



| | |
|--------------|------------|
| new | .29 |
| 50004 | .29 |
| € | 88,00 |

FILO

Griglia doccia rettangolare sganciabile

Removable rectangular shower basket / Panier douche rectangulaire amovible / Abnehmbarer Seifenablage rechteckig

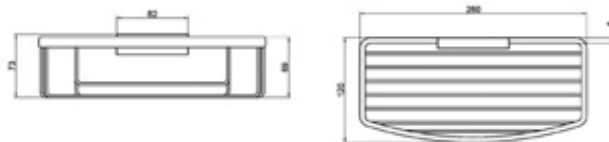

Acciaio inox cromato
Chromed stainless steel
Acier inoxydable chromé
Verchromter Poliert Edelstahl



new

50024

.29

€

88,00



Griglia doccia angolare

Corner shower basket / Panier douche angulaire / Seifenablage eckig

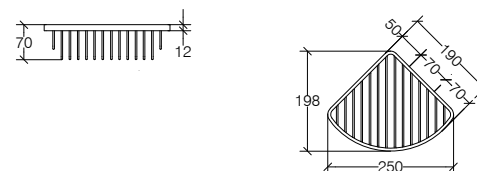

Acciaio inox cromato
Chromed stainless steel
Acier inoxydable chromé
Verchromter Poliert Edelstahl



50002

.29

€

57,00



Griglia doccia angolare

Corner shower basket / Panier douche angulaire / Seifenablage eckig

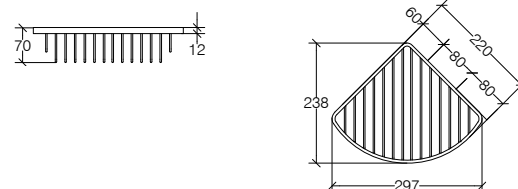

Acciaio inox cromato
Chromed stainless steel
Acier inoxydable chromé
Verchromter Poliert Edelstahl



50003

.29

€

64,00



Griglia doccia angolare

Corner shower basket / Panier douche angulaire / Seifenablage eckig

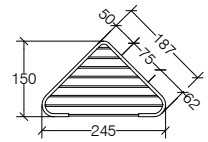

Acciaio inox cromato
Chromed stainless steel
Acier inoxydable chromé
Verchromter Poliert Edelstahl



| | |
|--------------|--------------|
| 50011 | .29 |
| € | 50,00 |

Griglia doccia angolare

Corner shower basket / Panier douche angulaire / Seifenablage eckig

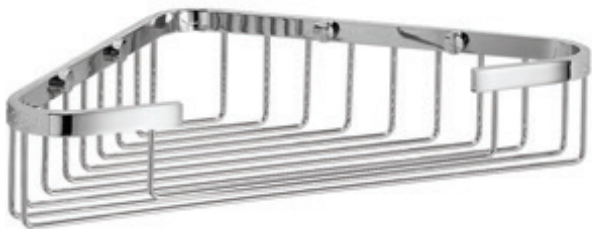
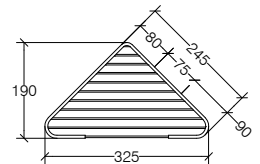

Acciaio inox cromato
Chromed stainless steel
Acier inoxydable chromé
Verchromter Poliert Edelstahl



| | |
|--------------|--------------|
| 50012 | .29 |
| € | 60,00 |

Griglia doccia angolare

Corner shower basket / Panier douche angulaire / Schwammkorb für Dusche

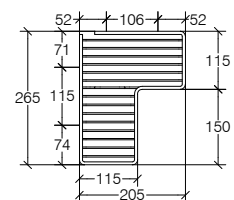
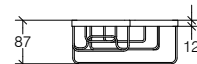

Acciaio inox cromato
Chromed stainless steel
Acier inoxydable chromé
Verchromter Poliert Edelstahl



| | |
|--------------|--------------|
| 50013 | .29 |
| € | 75,00 |

FILO

Portaoggetti da doccia

Basket for shower / Panier douche porte-objets / Schwammkorb für Dusche

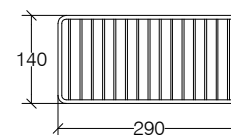
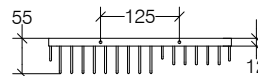

Acciaio inox cromato
Chromed stainless steel
Acier inoxydable chromé
Verchromter Poliert Edelstahl



50021

.29

€

64,00

Portaoggetti da doccia

Basket for shower / Panier douche porte-objets / Schwammkorb für Dusche

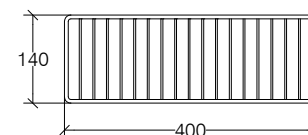
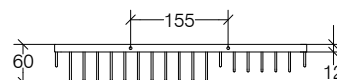

Acciaio inox cromato
Chromed stainless steel
Acier inoxydable chromé
Verchromter Poliert Edelstahl



50022

.29

€

76,00

RÈNTO

Nicchia ad incasso anche per zona doccia. Installazione rapida. Profondità parete >135 mm

Built-in niche for shower area. Quick installation. Wall depth >135 mm

Niche intégrée également pour espace douche. Installation rapide. Profondeur du mur >135 mm

Einbaunische auch für Duschbereich. Schnelle Installation. Wandtiefe >135 mm

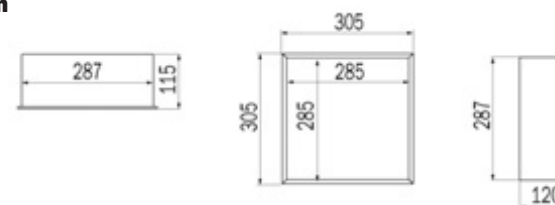

new

54192



.09



.23

€

130,00

130,00



disponibile da **APRILE 2024**
available from April 2024
disponible à partir d'avril 2024
Verfügbar ab April 2024

Spare parts _ Pièces détachées _ Ersatzteile _ **Ricambi**

| | | | |
|--------------|-----------|--|--------|
| 53830 | R1553830 | Pedana doccia Okumè - Okumè wood shower base | 135,00 |
| 53915 | R22539152 | Doccino cromato - Hand shower chrome | 36,00 |
| | R27539152 | Doccino satinato - Hand shower brushed | 87,00 |
| | R22539153 | Flessibile cromato - Flexible hose chrome | 36,00 |
| | R27539153 | Flessibile satinato - Flexible hose brushed | 41,00 |
| | R22539151 | Soffione per colonna inox lucido - Head shower stainless steel polished | 10,00 |
| | R27539151 | Soffione per colonna inox satinato - Head shower stainless steel brushed | 269,00 |
| 53917 | R2253917 | Cartuccia termostatica - Thermostatic cartige | 219,00 |
| 53810 | R2253807 | Riduttore portata 6 l/m - Water flow regulator 6 l/m | 7,00 |
| | R25538101 | Coppia viti maschio e femmina - Screw set | 7,00 |
| | R22538101 | Ugello per soffione - Ozzle for shower head | 6,00 |
| | R2353810 | Snodo per soffione - Articulated joint | 23,00 |
| | R2253810 | Ricambio guarnizione per soffione 53810 Ø 180 - Spare part for gasket 53810 Ø 180 mm | 16,00 |
| | R22538102 | Coppia guarnizioni per snodo soffione - Gasket couple for shower head joint | 7,00 |
| | R22538103 | Guarnizione con filtro per snodo - Gasket with filter for shower head joint | 7,00 |
| 53811 | R2253807 | Riduttore portata 6 l/m - Water flow regulator 6 l/m | 7,00 |
| | R25538101 | Coppia viti maschio e femmina - Screw set | 7,00 |
| | R2353810 | Snodo per soffione - Articulated joint | 23,00 |
| | R2253811 | Kit guarnizione Ø 230 per art. 53811 - Gasket kit Ø 230 for art. 53811 | 19,00 |
| | R22538101 | Ugello per soffione - Ozzle for shower head | 6,00 |
| | R22538102 | Coppia guarnizioni per snodo soffione - Gasket couple for shower head joint | 7,00 |
| | R22538103 | Guarnizione con filtro per snodo - Gasket with filter for shower head joint | 7,00 |
| 53812 | R2253812 | Riduttore portata 9 l/m - Water flow regulator 9 l/m | 7,00 |
| | R25538101 | Coppia viti maschio e femmina - Screw set | 7,00 |
| | R2353810 | Snodo per soffione - Articulated joint | 23,00 |
| | R22538121 | Guarnizione Gasket | 19,00 |
| | R22538101 | Ugello per soffione - Ozzle for shower head | 6,00 |
| | R22538102 | Coppia guarnizioni per snodo soffione - Gasket couple for shower head joint | 7,00 |
| | R22538103 | Guarnizione con filtro per snodo - Gasket with filter for shower head joint | 7,00 |

Ricambi _ Spare parts _ Pièces détachées _ Ersatzteile

| | | | |
|--------------|------------|---|-------|
| 53815 | R2253807 | Riduttore portata 6 l/m- Water flow regulator 6 l/m | 7,00 |
| | R25538101 | Coppia viti maschio e femmina - Screw set | 7,00 |
| | R2353810 | Snodo per soffione - Articulated joint | 23,00 |
| | R2253815 | Kit guarnizione 180x180 per art. 53815 - Gasket kit Ø 180x180 for art. 53815 | 16,00 |
| | R22538101 | Ugello per soffione - Ozzle for shower head | 6,00 |
| | R22538102 | Coppia guarnizioni per snodo soffione - Gasket couple for shower head joint | 7,00 |
| | R22538103 | Guarnizione con filtro per snodo - Gasket with filter for shower head joint | 7,00 |
| 53816 | R2253807 | Riduttore portata 6 l/m- Water flow regulator 6 l/m | 7,00 |
| | R25538101 | Coppia viti maschio e femmina - Screw set | 7,00 |
| | R2353810 | Snodo per soffione - Articulated joint | 23,00 |
| | R2253816 | Kit guarnizione 230x230 per art. 53816 - Gasket kit 230x230 for art. 53816 | 19,00 |
| | R22538101 | Ugello per soffione - Ozzle for shower head | 6,00 |
| | R22538102 | Coppia guarnizioni per snodo soffione - Gasket couple for shower head joint | 7,00 |
| | R22538103 | Guarnizione con filtro per snodo - Gasket with filter for shower head joint | 7,00 |
| 53817 | R2253812 | Riduttore portata 9 l/m - Water flow regulator 9 l/m | 7,00 |
| | R25538101 | Coppia viti maschio e femmina - Screw set | 7,00 |
| | R2253817 | Kit guarnizione 300x300 per art. 53817 - Gasket kit it 300x300 for art. 53817 | 23,00 |
| | R2353810 | Snodo per soffione - Articulated joint | 23,00 |
| | R22538101 | Ugello per soffione - Ozzle for shower head | 6,00 |
| | R22538102 | Coppia guarnizioni per snodo soffione - Gasket couple for shower head joint | 7,00 |
| | R22538103 | Guarnizione con filtro per snodo - Gasket with filter for shower head joint | 7,00 |
| 53801 | R2553801P | Placca rotonda per supporto doccia - Round platee for shower arm | 13,00 |
| 53802 | R2553801P | Placca rotonda per supporto doccia - Round platee for shower arm | 13,00 |
| 53804 | R2553801P | Placca rotonda per supporto doccia - Round platee for shower arm | 13,00 |
| 53806 | R2553806P | Placca quadra per supporto doccia - Square platee for shower arm | 14,00 |
| 53807 | R2553806P | Placca quadra per supporto doccia - Square platee for shower arm | 14,00 |
| 53808 | R2553806P | Placca quadra per supporto doccia - Square platee for shower arm | 14,00 |
| 53290 | R225329017 | Gomma puliscivetri grigio - Shower cleaner grey rubber | 8,00 |
| | R22532902 | Supporto puliscivetri gancio adesivo - Wall adhesive shower cleaner support | 14,00 |
| | R23532902 | Supporto metallo con adesivo - Metal support with adhesive | 17,00 |

Spare parts _ Pièces détachées _ Ersatzteile _ **Ricambi**

| | | | |
|-----------------|-----------|--|-------|
| 54180 | R22541801 | Flessibile 600 mm - 600 mm flexible hose | 13,00 |
| | R22541802 | Supporto saliscendi per asta doccia - Shower ups and downs ho | 25,00 |
| | R22541803 | Deviatore per colonna 54180 - Diverter for shower column 54180 | 70,00 |
| | R22541804 | O- ring asta doccia - Shower ups and downs O-ring | 6,00 |
| | R22541805 | Guarnizione in PVC - PVC gasket | 6,00 |
| | 541701.29 | Flessibile doppia maglia 1500 mm, con attacco conico da 1/2" - Double seam flexible hose 1500 mm, with 1/2" connection | 26,00 |
| 54174 | R22541802 | Supporto saliscendi per asta doccia - Shower ups and downs hook | 25,00 |
| 54175 | R22541751 | Saliscendi doccia ABS cromato quadro - Square chromed ABS ups and downs hook | 34,00 |
| | R22541752 | Mensola doccia ABS cromato quadro - Square chromed ABS shelf | 34,00 |
| 71804 | R2071804 | Kit fissaggio a muro - Wall mounting kit | 32,00 |
| 50002 | R2250014 | Confezione 4 viti + 4 tasselli + 4 copriviti per griglia doccia - 4 screws + 4 raw plug + 4 screw covers set | 7,00 |
| 50003 | R2250014 | Confezione 4 viti + 4 tasselli + 4 copriviti per griglia doccia - 4 screws + 4 raw plug + 4 screw covers set | 7,00 |
| 50011 | R2250014 | Confezione 4 viti + 4 tasselli + 4 copriviti per griglia doccia - 4 screws + 4 raw plug + 4 screw covers set | 7,00 |
| 50012 | R2250014 | Confezione 4 viti + 4 tasselli + 4 copriviti per griglia doccia - 4 screws + 4 raw plug + 4 screw covers set | 7,00 |
| 50013 | R2250014 | Confezione 4 viti + 4 tasselli + 4 copriviti per griglia doccia - 4 screws + 4 raw plug + 4 screw covers set | 7,00 |
| 50021 | R2250012 | Confezione 2 viti + 2 tasselli + 2 copriviti per griglia doccia - 2 screws + 2 raw plug + 2 screw covers set | 6,00 |
| 50028.23 | R5002802 | Attacco per regolazione - Regulation attachment | 15,00 |
| 50028.29 | R5002801 | Attacco per regolazione - Regulation attachment | 12,00 |
| 50028.09 | R5002803 | Attacco per regolazione - Regulation attachment | 15,00 |
| 50022 | R2250012 | Confezione 2 viti + 2 tasselli + 2 copriviti per griglia doccia - 2 screws + 2 raw plug + 2 screw covers set | 6,00 |
| 50030 | R2250030 | Gommino plastica - Plastic rubber tip | 6,00 |
| 50031 | R2250030 | Gommino plastica - Plastic rubber tip | 6,00 |
| 50032 | R2250014 | Confezione 4 viti + 4 tasselli + 4 copriviti per griglia doccia - 4 screws + 4 raw plug + 4 screw covers set | 7,00 |
| 50033 | R2250014 | Confezione 4 viti + 4 tasselli + 4 copriviti per griglia doccia - 4 screws + 4 raw plug + 4 screw covers set | 7,00 |

Hotel & Contract

Contract _ Hôtellerie _ Hotel

Maniglione di sicurezza _ 244

Grab security bar _ Barre d'appui _ Sicherheitsgriff

Asciugacapelli _ 248

Hairdryer _ Sèche-cheveux _ Haartrockner

Porta fazzoletti _ 252

Kleenexbox _ Porte-mouchoirs _ Kleenexbox





OTHELLO

OTHELLO

Maniglione di sicurezza

Grab security bar / Barre d'appui / Sicherheitsgriff

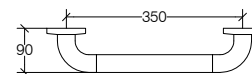
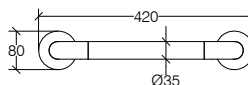

Nylon - Acciaio inox
Nylon - stainless steel
Nylon - acier inoxydable
Nylon - Edelstahl



53104

€

52,00



Maniglione di sicurezza reversibile

Reversible grab security bar / Barre d'appui réversible / Sicherheitsgriff wechselseitig

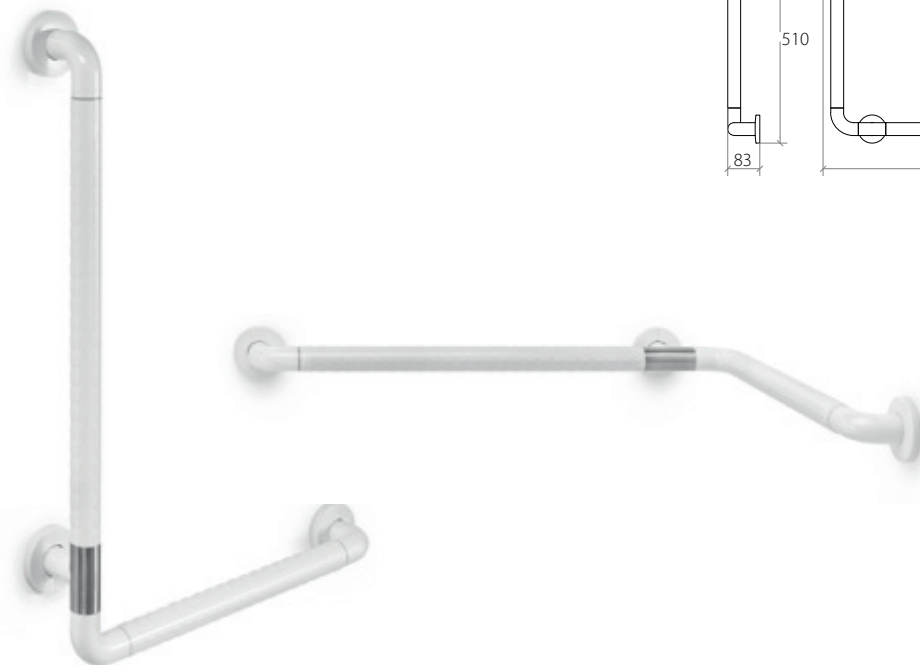
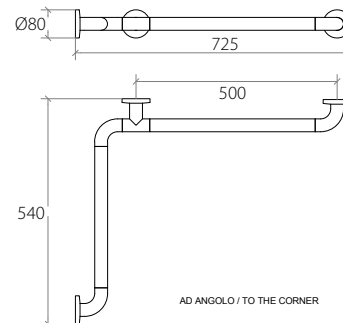
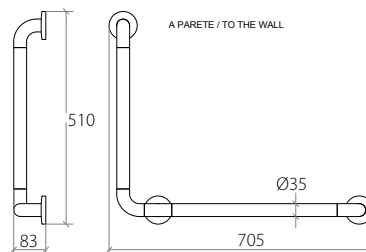

Nylon - Acciaio inox
Nylon - Stainless steel
Nylon - Acier inoxydable
Nylon - Edelstahl



53105

€

109,00



OTHELLO

Maniglione di sicurezza ribaltabile

Folding safety support / Barre d'appui rabattabile / Klapp-Sicherheitsgriff

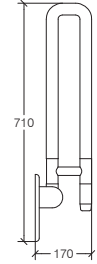
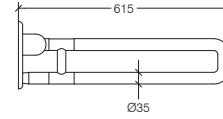

Portata massima 360 Kg

Max weight 360 Kg
Poids maximum 360 Kg
Maximales Gewicht 360 Kg



Nylon - Acciaio inox
Nylon - Stainless steel
Nylon - Acier inoxydable
Nylon - Edelstahl



53106

€

263,00

Maniglione di sicurezza reversibile con porta sapone

Reversible grab security bar with soap holder / Barre d'appui réversible avec porte-savon
Sicherheitsgriff mit Seifenkorb reversibel

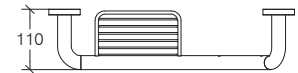
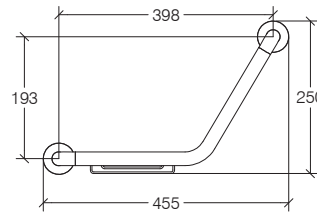

Ottone cromato
Chromed brass
Laiton chromé
Verchromtes Messing



53101

€

.29

98,00

OTHELLO

Maniglione di sicurezza reversibile

Reversible grab security bar / Barre d'appui réversible / Reversibel Sicherheitsgriff

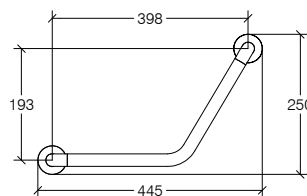

Ottone cromato
Chromed brass
Laiton chromé
Verchromtes Messing



53102

.29

€

90,00

Maniglione di sicurezza

Grab security bar / Barre d'appui / Sicherheitsgriff

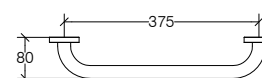
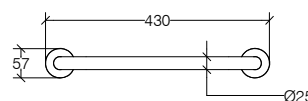

Ottone cromato
Chromed brass
Laiton chromé
Verchromtes Messing



53103

.29

€

75,00

Maniglione di sicurezza

Grab security bar / Barre d'appui / Sicherheitsgriff

**Portata massima 150 Kg**

Max weight 150 Kg

Poids maximum 150 Kg

Maximales Gewicht 150 Kg



Ottone cromato
Chromed brass
Laiton chromé
Verchromtes Messing

**53160****.29**

€

47,00

Maniglione sicurezza 800x450 inox lucido

Grab security bar 800x450 / Barre d'appui 800x450 / Sicherheitsgriff 800x450

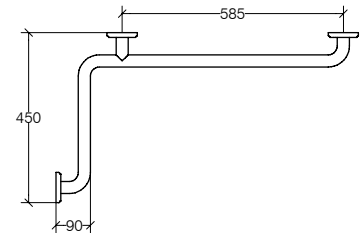
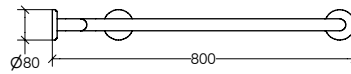

Acciaio inox lucido
Polished stainless steel
Acier inoxydable brillant
Poliert Edelstahl

**55761****.29**

€

132,00

OTHELLO

Asciugacapelli compatto a parete 1400 Watt

Wall hairdryer 1400 W / Sèche-cheveux électrique mural 1400 W - Wand-Haartrockner 1400 W

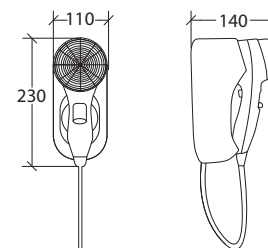

ABS
ABS
ABS
ABS



| Volt | Watt | dB(A) | MC/H |
|---------|--------------|-------|------|
| 220/240 | 130/650/1300 | 58 | 79 |

| | |
|---------------|------------|
| 532621 | .09 |
| € | 72,00 |

Asciugacapelli professionale 1600 Watt

Professional hairdryer 1600 W / Sèche-cheveux électrique professionnel 1600 W - Haartrockner Fachmann 1600 W

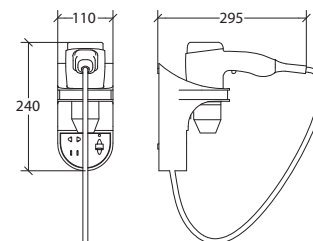

ABS
ABS
ABS
ABS



ABS
ABS
ABS
ABS



| Volt | Watt | dB(A) | MC/H |
|---------|--------------|-------|------|
| 220/240 | 115/900/1470 | 60 | 79 |

| | | |
|--------------|------------|------------|
| 53264 | .09 | .23 |
| € | 151,00 | 151,00 |

Asciugamani elettrico a parete in acciaio inox con attivazione sensore di movimento 220-240 V - 500 Watt

Wall handdryer with motion sensor activation in stainless steel 220-240 V - 500 Watt
 Sèche-mains électrique avec capteur de mouvement en acier inox 220-240 V - 500 Watt
 Elektronischer Wandtrockner mit Sensor aus Edelstahl 220-240 V - 500 Watt

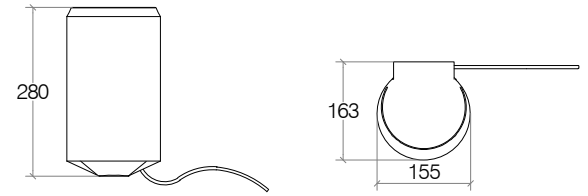

OTHELLO

Acciaio inox lucido
 Polished stainless steel
 Acier inoxydable brillant
 Poliert Edelstahl



| | |
|--------------|------------|
| 53266 | .29 |
| € | 239,00 |

OTHELLO

Dispenser automatico gel con sensore, capacità 1 litro

Automatic gel dispenser with sensor 1 Lt / Distributeur de gel automatique avec capteur 1 Lt / Automatischer Gelspender mit Sensor 1 Lt

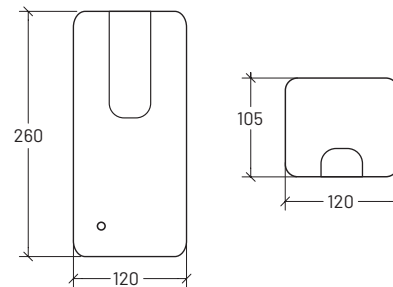

ABS
ABS
ABS
ABS



53273

.09

€

115,00

Colonna supporto dispenser

Dispenser support column / Colonne de support de distributeur / Stützsäule des Spenders

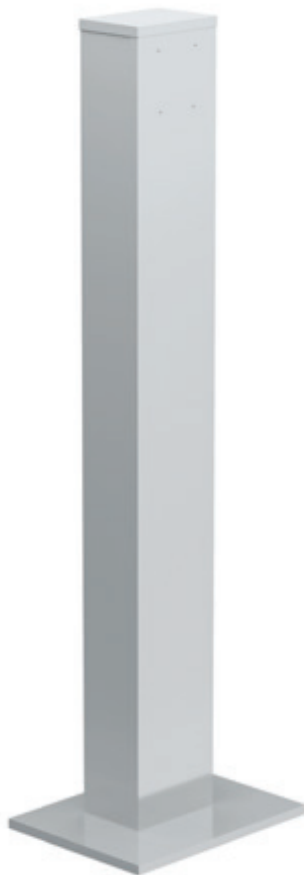

Salvagoccia incluso
Drop-catcher included
Protège-gouttes inclus
Abtropfplatte enthalten

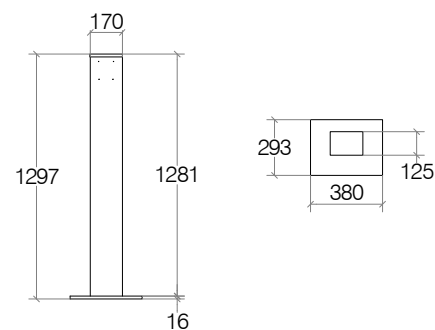

Laccato lucido
Glossy lacquered
Laqué brillant
Glänzend Lackiert



53276

.09

€

150,00



OTHELLO**Dosatore a parete singolo 400 ml**

Wall bearing liquid soap dispenser 400 ml / Distributeur savon liquide mural 400 ml / Wandseifenspendler 400 ml

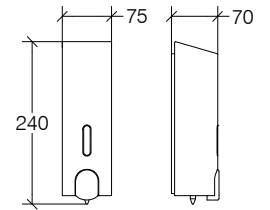

ABS cromato
Chromed ABS
ABS chromé
verchromtes ABS

**53267****.29**

€

40,00

Salvagoccia

Drop-catcher / Protège-gouttes / Abtropfplatte

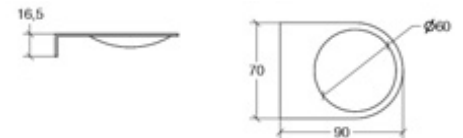
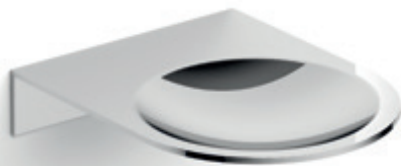

Acciaio inox lucido
Polished stainless steel
Acier inoxydable brillant
Poliert Edelstahl

**53269****.29**

€

36,00

Filo stendibiancheria 250 cm, portata 3 kg

Retractable clothesline 250 cm, max weight 3 kg for inhouse use

Fil étendoir 250 cm, portée 3 kg

Wäscheleine 250 cm, Tragfähigkeit 3 Kg

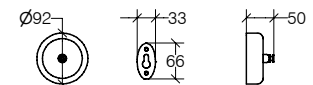

Acciaio inox lucido
Polished stainless steel
Acier inoxydable brillant
Poliert Edelstahl

**53295****.29**

€

44,00

OTHELLO

Porta sacchetti igienici

Jumbo roll toilet tissue dispenser / Porte sachets hygiéniques / Spender für Toilettenpapier Jumbo

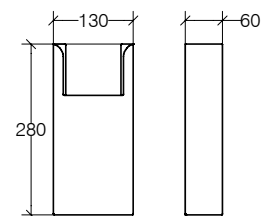

Acciaio inox lucido
Polished stainless steel
Acier inoxydable brillant
Poliert Edelstahl



53293

.29

€

52,00

Porta sacchetti igienici a muro

Wall sanitary bag holder / Distributeur sachets hygiéniques mural / Hygienebeutelspender am Wand

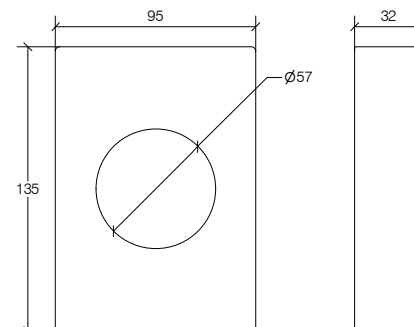

Acciaio inox lucido
Polished stainless steel
Acier inoxydable brillant
Poliert Edelstahl



53272

.29

€

48,00



OTHELLO

Distributore di carta interfogliata

Interleaved paper dispenser / Distributeur de papier interfolié / Spender für verschachteltes Papier

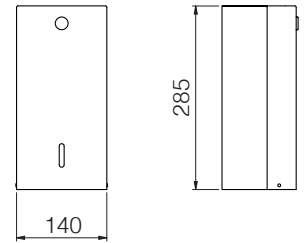

Acciaio inox lucido
Polished stainless steel
Acier inoxydable brillant
Poliert Edelstahl

Acciaio inox verniciato
Painted stainless steel
Acier inoxydable laqué
Lackiertem Edelstahl

Acciaio inox satinato
Satinated stainless steel
Acier inoxydable satiné
Vereist Edelstahl



new

| | | | |
|--------------|------------|------------|------------|
| 53277 | .29 | .23 | .32 |
| € | 150,00 | 170,00 | 165,00 |

Distributore jumbo carta igienica

Distributore jumbo carta igienica / Distributeur de papier hygiénique Jumbo / Spender für Toilettenpapier Jumbo

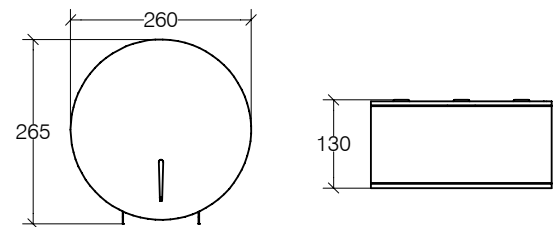

Acciaio inox lucido
Polished stainless steel
Acier inoxydable brillant
Poliert Edelstahl



| | |
|--------------|------------|
| 53292 | .29 |
| € | 129,00 |

OTHELLO

Distributore asciugamani di carta

Paper towels dispenser / Distributeur de serviettes en papier / Papiertücherspender

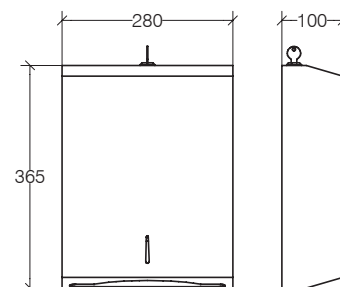

Dimensione fazzoletti 225x105 mm

Handkerchief size 225x105 mm
 Taille du mouchoir 225x105 mm
 Taschentuch Größe 225x105 mm

Acciaio inox lucido
 Polished stainless steel
 Acier inoxydable brillant
 Poliert Edelstahl



53294

.29

€

162,00

Porta fazzoletti da appoggio

Table kleenexbox / Porte-mouchoirs à poser / Kleenexbox am Tisch

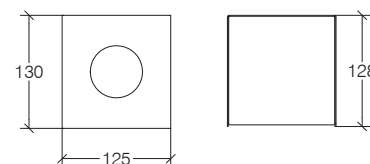

Acciaio inox lucido
 Polished stainless steel
 Acier inoxydable brillant
 Poliert Edelstahl



53270

.29

€

66,00



OTHELLO**Porta fazzoletti da appoggio**

Table kleenexbox / Porte-mouchoirs à poser / Kleenexbox am Tisch

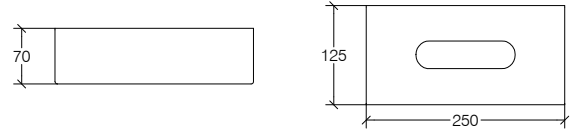
Acciaio inox lucido
 Polished stainless steel
 Acier inoxydable brillant
 Poliert Edelstahl
**53271****.29**

€

66,00

Porta fazzoletti da parete e da appoggio

Wall/table kleenexbox / Porte-mouchoirs à poser ou mural / Kleenexbox am Tisch/Wand



Acciaio inox lucido
 Polished stainless steel
 Acier inoxydable brillant
 Poliert Edelstahl
**new****53274****.29**

€

77,00

Contentore portasalviette

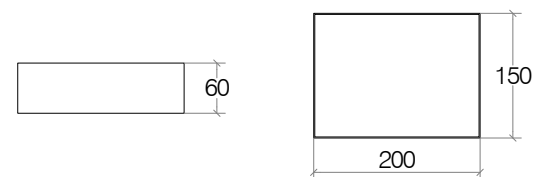
Hand towels box / Récipient porte-serviettes lave-mains / Behälter für Schalehandtücher

Acciaio inox lucido
 Polished stainless steel
 Acier inoxydable brillant
 Poliert Edelstahl
**44281****.29**

€

81,00

Ricambi _ Spare parts _ Pièces détachées _ Ersatzteile

| | | | |
|--------------|-----------|--|-------|
| 53267 | R22532672 | Pompetta ABS per dosatori 53267 - ABS pump for dispensers art. 53267 | 10,00 |
| | R22532673 | Flacone 350 ml - 350 ml bottle | 8,00 |
| | R22532674 | Pulsante in plastica - Plastic button | 14,00 |
| 53292 | R23532921 | Chiavetta per distributore 53292 - Key for dispenser 53292 | 7,00 |
| 53294 | R23532941 | Ricambio serratura con chiave - Key and lock replacement | 10,00 |
| 53277 | R5327701 | Ricambio serratura con chiave - Key and lock replacement | 20,00 |



RICAMBI



specchi & lampade

Mirrors and Lamps _ Miroirs et Lampes _ Spiegel und Lampen

Specchi ingranditori _ 260

Magnifying mirrors _ Miroirs grossissants _ Wand-Vergrößerungsspiegel

Specchi illuminati _ 268

Mirrors with light _ Miroirs avec lumière _ Spiegel mit licht

Specchi _ 286

Mirrors _ Miroirs _ Spiegel

Lampade _ 292

Lamps _ Lampes _ Lampen



SPECI



Specchi ingranditori

Magnifying mirrors / Miroirs grossissants / Wand-Vergrößerungsspiegel

MEVEDO: mi vedo.

Dai classici specchi quadrati o rettangolari da tavolo, a quelli rotondi estensibili e a parete: gli alleati per il make up e la cura del viso.

EN

MEVEDO:
I see myself.

From the classic square or rectangular table mirrors to the extensible round and wall mirrors: the perfect allies for make up and face care.

FR

MEVEDO :
Je me vois.

Des classiques miroirs à poser carrés ou rectangulaires, aux miroirs ronds extensibles et muraux : les alliés du maquillage et du soin du visage.

DE

MEVEDO:
ich sehe mich.

Von den klassischen quadratischen und rechteckigen Tischspiegeln bis zu den erweiterbaren Rundspiegeln und Wandspiegeln: die Verbündeten für das Make-up und die Gesichtspflege.

Finiture _ Finishes _ Finitions _ Ausführung:

Ottone cromato
Chromed brass
Laiton chromé
Verchromtes Messing



.29

Acciaio inox lucido
Polished stainless steel
Acier inoxydable brillant
Poliert Edelstahl



.29

Bianco opaco
Matt white
Blanc mat
Matt Weiß



.09

Antracite opaco
Matt anthracite
Anthracite mat
Matt Anthrazit



.17

Nero opaco
Matt black
Noir mat
Matt Schwarz



.23

MEVEDO

Specchio ingranditore con luce LED da appoggio

Magnifying table mirror with LED light / Miroir grossissant à poser avec lumière LED
Vergrößerungsspiegel LED Licht Standmodell

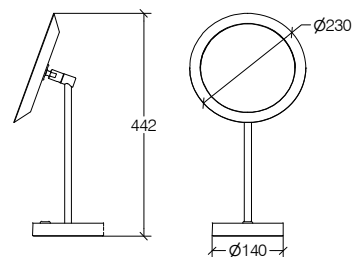

Ottone cromato
Chromed brass
Laiton chromé
Verchromtes Messing



| | |
|--------------|------------|
| 55862 | .29 |
| € | 273,00 |

Specchio ingranditore luce LED a parete

Magnifying wall mirror with LED light / Miroir grossissant mural avec lumière LED
Vergrößerungsspiegel LED Licht Wandmodell

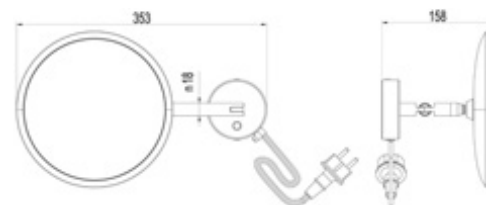

Ottone cromato
Chromed brass
Laiton chromé
Verchromtes Messing



| | |
|--------------|------------|
| new | |
| 55865 | .29 |
| € | 250,00 |

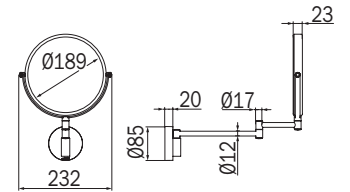

MEVEDO

Specchio ingranditore 1 lato ingranditore 3x ed 1 lato ingranditore 5X, a pareteWall mirror, 1 side true image 5x, 1 side true image 3x / Miroir grossissant 3X et Miroir grossissant 5X (2 faces), mural
Wandspiegel, 1 Seite wahres Bild 5x, 1 Seite wahres Bild 3x Wandmodell

Ottone cromato
Chromed brass
Laiton chromé
Verchromtes Messing

3x 5x



55853



.29

€

164,00

Specchio ingranditore a parete

Wall magnifying mirror / Miroir grossissant mural / Vergrößerungsspiegel Wandmodell

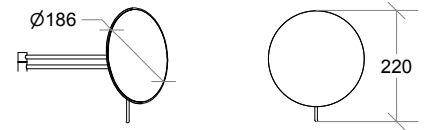

Ottone cromato
Chromed brass
Laiton chromé
Verchromtes Messing

3x



5588



.29

€

140,00

Specchio ingranditore orientabile a parete

Wall magnifying mirror / Miroir grossissant mural / Vergrößerungsspiegel Wandmodell

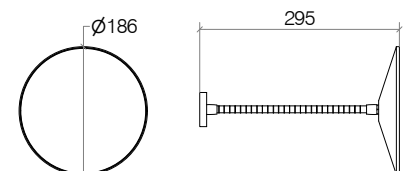
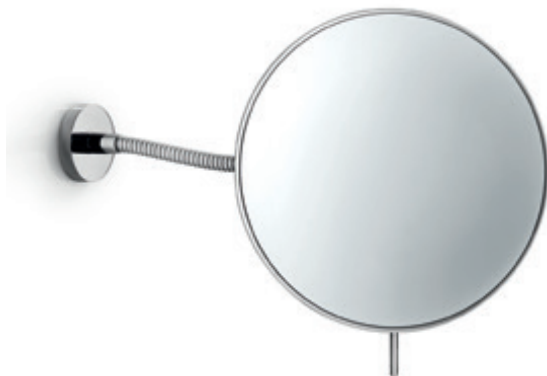

Ottone cromato
Chromed brass
Laiton chromé
Verchromtes Messing

3x 5x 8x **Disponibile .3X magnifying .5X magnifying e .8X magnifying**
Available also / Disponible en / Verfügbar also



5591.29

5591.29.5X

5591.29.8X

€

108,00

MEVEDO

Specchio ingranditore a parete

Wall magnifying mirror / Miroir grossissant mural / Vergrößerungsspiegel Wandmodell

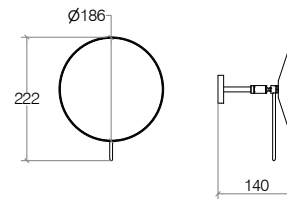

Ottone cromato
Chromed brass
Laiton chromé
Verchromtes Messing

3x **5x** **8x** **Disponibile .3X magnifying .5X magnifying e .8X magnifying**
Available also / Disponible en / Verfügbar also



| | |
|--------------------|---|
| 55963.29 |  |
| 55963.29.5X | |
| 55963.29.8X | |
| € | 112,00 |

Specchio ingranditore a parete

Wall magnifying mirror / Miroir grossissant mural / Vergrößerungsspiegel Wandmodell

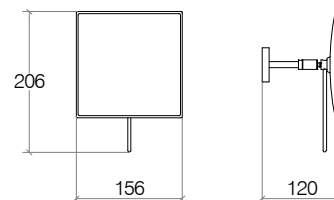

Ottone cromato
Chromed brass
Laiton chromé
Verchromtes Messing

3x



| | |
|-------------|---------------|
| 5595 | .29 |
| € | 112,00 |

Specchio ingranditore a parete

Wall magnifying mirror / Miroir grossissant mural / Vergrößerungsspiegel Wandmodell

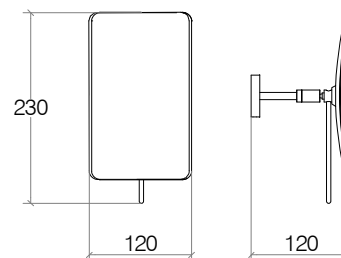

Ottone cromato
Chromed brass
Laiton chromé
Verchromtes Messing

3x



| | |
|-------------|---------------|
| 5596 | .29 |
| € | 112,00 |

MEVEDO

Specchio ingranditore 1 lato riflettente ed 1 lato ingrandente 3x da appoggioTable mirror, 1 side magnifying 3x, 1 side true image / Miroir grossissant et normal 3x (2 faces), à poser
Vergrößerungsspiegel 3x (nur eine Seite Vergrößerung) Standmodell

3x

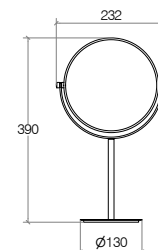

Ottone cromato
Chromed brass
Laiton chromé
Verchromtes Messing



55851

.29

€

156,00

Specchio ingranditore da appoggio

Magnifying table mirror / Miroir grossissant à poser / Vergrößerungsspiegel Standmodell



3x

5x

8x

Disponibile .3X magnifying .5X magnifying e .8X magnifying
Available also / Disponible en / Verfügbar also

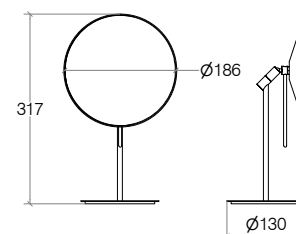

Ottone cromato
Chromed brass
Laiton chromé
Verchromtes Messing



55943.29

55943.29.5X

55943.29.8X

€

151,00

Specchio ingranditore da appoggio

Magnifying table mirror / Miroir grossissant à poser / Vergrößerungsspiegel Standmodell



3x

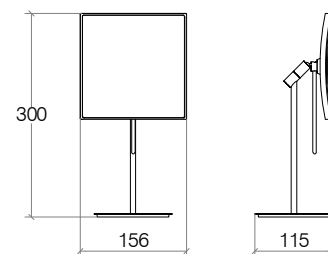

Ottone cromato
Chromed brass
Laiton chromé
Verchromtes Messing



5593

.29

€

156,00

MEVEDO

Specchio ingranditore da appoggio

Magnifying table mirror / Miroir grossissant à poser / Vergrößerungsspiegel Standmodell



3x

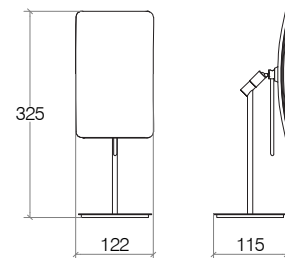

Ottone cromato
Chromed brass
Laiton chromé
Verchromtes Messing



| | |
|-------------|------------|
| 5594 | .29 |
| € | 156,00 |

Specchio ingranditore da appoggio con contenitore

Magnifying table mirror with container / Miroir grossissant à poser avec rangement / Vergrößerungsspiegel mit Container



ITALY

5x

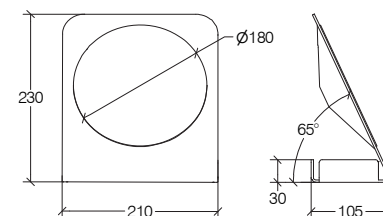

Verniciato bianco
White painted
Blanc laqué
Lackiertem Weiß

Verniciato nero
Black painted
Noir laqué
Lackiertem Schwarz

Acciaio inox lucido
Polished stainless steel
Acier inoxydable brillant
Poliert Edelstahl



| | | | |
|--------------|------------|------------|------------|
| 55864 | .09 | .23 | .29 |
| € | 135,00 | 135,00 | 190,00 |

Spare parts / Pièces détachées / Ersatzteile / **Ricambi**

| | | | |
|---------------|-----------|--|-------|
| 5588 | R2555882 | Kit ricambio specchio tondo completo - Round mirror kit | 70,00 |
| | R25559351 | Snodo specchio 45° - Mirror 45° hinge | 16,00 |
| | R2555889 | Braccio ingranditore completo - Entire magnifying arm | 80,00 |
| 5591 | R2555882 | Kit ricambio specchio tondo completo - Round mirror kit | 70,00 |
| 5592 | R2555882 | Kit ricambio specchio tondo completo - Round mirror kit | 70,00 |
| 5593 | R2555932 | Kit ricambio specchio quadro completo - Square mirror kit | 70,00 |
| | R25559352 | Snodo specchio - Mirror hinge | 16,00 |
| 5594 | R2555932 | Kit ricambio specchio quadro completo - Square mirror kit | 70,00 |
| | R25559352 | Snodo specchio - Mirror hinge | 16,00 |
| 55943 | R2555882 | Kit ricambio specchio tondo completo - Round mirror kit | 70,00 |
| | R25559352 | Snodo specchio - Mirror hinge | 16,00 |
| 5595 | R2555932 | Kit ricambio specchio quadro completo - Square mirror kit | 70,00 |
| | R25559351 | Snodo specchio 45° - Mirror 45° hinge | 16,00 |
| 5596 | R2555942 | Kit ricambio specchio rettangolare completo - Rectangular mirror kit | 70,00 |
| | R25559351 | Snodo specchio 45° - Mirror 45° hinge | 16,00 |
| 55963 | R2555882 | Kit ricambio specchio tondo completo - Round mirror kit | 70,00 |
| | R25559351 | Snodo specchio 45° - Mirror 45° hinge | 16,00 |
| 558 51 | R25558515 | Cornice completa con 2 specchi - Frame with 2 mirrors | 51,00 |
| | R25558513 | Forcella U - Forked rod for mirror | 83,00 |



Specchi illuminati

Mirrors with light / Miroirs avec lumière / Spiegel mit licht

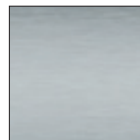
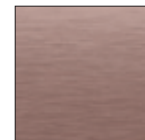
Finiture _ Finishes _ Finitions _ Ausführung:**Verniciato bianco**Painted white
Laqué blanc
Lackiertem Weiß**.09****Verniciato nero**Painted black
Laqué noir
Lackiertem Schwarz**.23****Verniciato metal**Painted metal
Laqué métal
Lackiertem Metal**.32****Rosa metallizzato opaco**Metallic pink matt
Rose métallisé mat
Metallisch rosa matt**.55****Metallo bronzo**Bronze metal
Métal bronze
Bronze Metall**.35**

SPECI



Tutte le lastre sono di fabbricazione ecologica realizzate senza piombo né rame. Oltre ad essere sicure per l'ambiente, le lastre specchio di questo tipo sono resistenti all'umidità e alla corrosione, offrendo un'immagine chiara, naturale e realistica.

All the mirrors follow an ecological manufacturing process that do not imply the use of lead or copper. More than being environmentally friendly, the mirrors of this kind are resistant to humidity and corrosion, assuring then a clear, natural and realistic image.

Toutes les plaques sont de fabrication écologique sans plomb ni cuivre. En plus d'être sans danger pour l'environnement, les plaques miroir de ce type résistent à l'humidité et à la corrosion, offrant une image claire, naturelle et réaliste.

Alle Platten sind umweltfreundlich hergestellt ohne Blei oder Kupfer. Spiegelplatten dieser Art sind nicht nur umweltfreundlich, sondern auch feuchtigkeits- und korrosionsbeständig und bieten somit ein klares, natürliches und realistisches Bild.



(AF) Antiappannamento (optional): molti dei nostri specchi possono essere attrezzati con una resistenza antiappannamento che consente di mantenere la superficie dello specchio asciutta e senza condensa. L'antiappannamento si attiva all'accensione della luce principale dello specchio. La superficie coperta dall'antiappannamento varia in proporzione alle dimensioni dello specchio per consentire sempre un'ampia area senza condensa. In caso di specchio con larghezza superiore a 140cm le resistenze antiappannamento saranno sempre due per un migliore posizionamento rispetto al lavabo.

(AF) Steam-free heated pad (optional): many of our mirrors can be equipped with a steam-free heated pad that allows to keep the mirror surface dry and without steam. The pad is turned on at the same time as the main light of the mirror. The pad dimensions change according to the mirror ones, to always keep a wide part with no steam. When the mirror length is more than 140cm, there are always two pads for a better positioning in relation to the basin.

(AF) Antibuée (en option) : beaucoup de nos miroirs peuvent être équipés d'une résistance antibuée qui maintient la surface du miroir sèche et exempte de condensation. Le désembuage est activé lorsque l'éclairage principal du miroir est allumé. La surface couverte par l'antibuée varie proportionnellement à la dimension du miroir pour toujours laisser une grande surface sans condensation. Dans le cas d'un miroir d'une largeur supérieure à 140cm, les résistances antibuée seront toujours au nombre de deux pour un meilleur positionnement par rapport au lavabo.

(AF) Antibeschlag (optional): Viele unserer Spiegel können mit einer Antibeschlagheizung ausgestattet werden, die die Spiegeloberfläche trocken und frei von Kondensation hält. Die Beschlagentfernung wird aktiviert, wenn das Hauptspiegellicht eingeschaltet wird. Die vom Antibeschlag bedeckte Oberfläche variiert proportional zur Größe des Spiegels, damit ein großer Bereich ohne Kondensation ermöglicht wird. Bei einem Spiegel mit einer Breite von mehr als 140 cm sind immer zwei Antibeschlag-Widerstände vorhanden, um eine bessere Positionierung in Bezug auf das Waschbecken zu gewährleisten.



(BT) Bluetooth (optional): collegamento bluetooth per ascoltare direttamente dallo specchio la musica riprodotta dal proprio dispositivo. Lo speciale sistema di diffusione del suono, invece di utilizzare altoparlanti tradizionali, sfrutta il telaio dello specchio come cassa di risonanza; in questo modo offre una qualità del suono ottima su qualsiasi specchio.

(BT) Bluetooth (optional): Bluetooth connection to listen to the music from your device directly through the mirror. This special system of sound diffusion takes advantage of the mirror frame as a sounding board instead of using traditional loudspeakers; in this way, we guarantee a premium sound quality on every mirror even.

(BT) Bluetooth (en option) : Connexion Bluetooth pour écouter la musique sur votre appareil directement depuis le miroir. Le système spécial de diffusion du son, au lieu d'utiliser des haut-parleurs traditionnels, utilise le cadre du miroir comme caisse de résonance ; de cette manière, il offre une excellente qualité sonore sur n'importe quel miroir.

(BT) Bluetooth (optional): Bluetooth-Verbindung, um die gespeicherte Musik direkt über den Spiegel zu hören. Das spezielle Schalldiffusionssystem verwendet anstelle herkömmlicher Lautsprecher den Rahmen des Spiegels als Resonanzkasten. Hervorragende Klangqualität an jedem Spiegel.

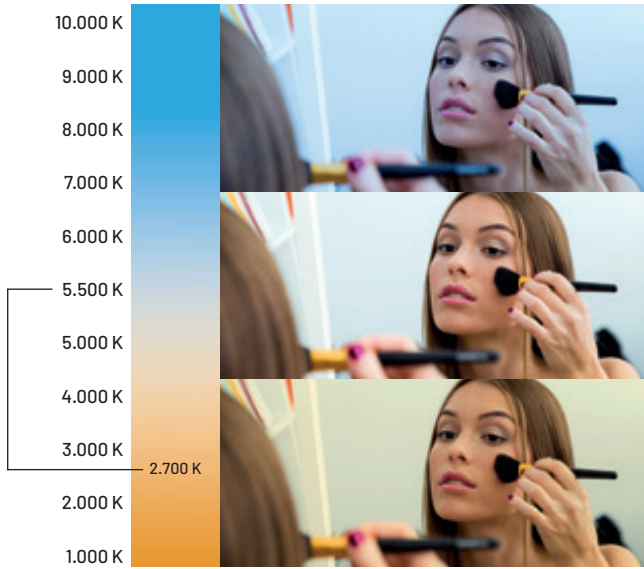

La luce degli specchi Lineabeta può essere impostata su colori differenti (temperatura della luce), passando da toni più caldi (minimo 2700 Kelvin) a toni più freddi (massimo 5500 Kelvin).

La temperatura della luce viene misurata in gradi Kelvin (K). Questo valore indica quale tonalità di colore assume la luce emessa da una sorgente luminosa.

The light of Inda mirrors can be set on different colours (light temperature), going from warmer shades (minimum 2700 Kelvin) to colder ones (maximum 5500 Kelvin).

The light temperature is measured in Kelvin degrees (K). This number indicates the colour shade of the light coming from a lighting source.

La lumière des miroirs Inda peut être réglée sur différentes couleurs (température de la lumière), passant des tons les plus chauds (minimum 2700 Kelvin) aux tons les plus froids (maximum 5500 Kelvin).

La température de la lumière se mesure en degrés Kelvin (K). Cette valeur indique la tonalité de couleur que prend la lumière émise par une source lumineuse.

Das Licht der Spiegel INDA kann auf verschiedene Farben (Lichttemperatur) eingestellt werden, die von wärmeren Tönen (mindestens 2700 Kelvin) bis zu kälteren Tönen (maximal 5500 Kelvin) reichen.

Die Lichttemperatur wird in Grad Kelvin (K) gemessen. Dieser Wert gibt an, welchen Farbton, das von einer Lichtquelle abgegebene Licht, annimmt.



I LED che riportano l'icona  hanno led sostituibili che possono essere sostituiti da personale qualificato.

The LEDs displaying the icon  have replaceable LEDs that can be replaced by qualified personnel.

Les LED affichant l'icône  ont des LED remplaçables qui peuvent être remplacées par du personnel qualifié.

Die LEDs, die das Symbol  anzeigen, haben austauschbare LEDs, die von qualifiziertem Personal ersetzt werden können."



(IP44) La "resistenza" offerta dall'apparecchio alla penetrazione di solidi e liquidi viene indicata dal prefisso IP (International Protection) seguita da 2 cifre significative, di cui la prima identifica il grado di protezione contro l'ingresso dei corpi solidi e la seconda dei liquidi.

(IP44) The appliance "resistance" to solids and liquids intrusion, is indicated by the IP (International Protection) code followed by two significant numbers, the first identifying the protection level against solid parts intrusions and the second against liquids.

(IP44) La "résistance" offerte par l'appareil contre la pénétration de solides et de liquides est indiquée par le préfixe IP (international protection) suivi de 2 chiffres significatifs: le premier indique le degré de protection contre l'entrée de corps solides et la second contre celle de liquides.

(IP44) Der durch das Gerät gebotene „Widerstand“ hinsichtlich des Eindringens von festen und flüssigen Fremdstoffen wird durch die Abkürzung IP (International Protection), gefolgt von zwei Kennziffern, von denen die erste die Schutzstufe hinsichtlich fester und die zweite hinsichtlich flüssiger Fremdstoffe betrifft, gekennzeichnet.

PYXIS

Specchio con telaio in alluminio verniciato. Con luce frontale verticale interno telaio per un'illuminazione senza ombre. Solo collegamento a rete

Mirror with painted aluminium frame. With vertical front light inside the frame for perfect illumination. Mains connection only.

Miroir avec cadre en aluminium laqué. Avec lumière frontale verticale à l'intérieur du cadre pour un éclairage sans ombre. Branchement sur secteur uniquement.

Spiegel mit lackiertem Aluminiumrahmen. Mit vertikalem Frontlicht im Inneren des Rahmens für perfekte Ausleuchtung. Nur Netzanschluss.

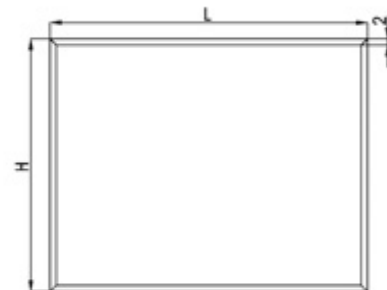

in foto: specchio argento con Antifog
in photo: silver mirror with Antifog
sur la photo : miroir argent avec Antifog
im Bild: Silber Spiegel mit Antifog:

S1920140AF.32



new

| H mm. | L mm. | Sp mm. | Watt | L/MT | COD. | .09 | .23 | .32 | .55 | .35 | |
|-------|-------|--------|------|------|-----------------|-----|-----|-----|--------|--------|--------|
| 800 | 600 | 65 | 20 | 1700 | S1920110 | | | | 410,00 | 515,00 | 545,00 |
| 800 | 800 | 65 | 20 | 1700 | S1920120 | | | | 428,00 | 535,00 | 570,00 |
| 800 | 900 | 65 | 20 | 1700 | S1920125 | | | | 438,00 | 550,00 | 590,00 |
| 800 | 1000 | 65 | 20 | 1700 | S1920130 | | | | 451,00 | 565,00 | 625,00 |
| 800 | 1200 | 65 | 20 | 1700 | S1920140 | | | | 475,00 | 595,00 | 660,00 |
| 800 | 1400 | 65 | 20 | 1700 | S1920150 | | | | 485,00 | 610,00 | 690,00 |

new

| H mm. | L mm. | Sp mm. | Watt | L/MT | COD. | .09 | .23 | .32 | .55 | .35 | |
|-------|-------|--------|------|------|-------------------|-----|-----|-----|--------|--------|--------|
| 800 | 600 | 65 | 58 | 1700 | S1920110AF | | | | 480,00 | 585,00 | 615,00 |
| 800 | 800 | 65 | 75 | 1700 | S1920120AF | | | | 498,00 | 605,00 | 640,00 |
| 800 | 900 | 65 | 90 | 1700 | S1920125AF | | | | 508,00 | 620,00 | 660,00 |
| 800 | 1000 | 65 | 90 | 1700 | S1920130AF | | | | 541,00 | 655,00 | 715,00 |
| 800 | 1200 | 65 | 125 | 1700 | S1920140AF | | | | 565,00 | 685,00 | 750,00 |
| 800 | 1400 | 65 | 125 | 1700 | S1920150AF | | | | 575,00 | 700,00 | 780,00 |



Specchio con telaio in alluminio verniciato. Luce frontale verticale interno telaio per un'illuminazione perfetta e senza ombre.

Mirror with painted aluminium frame. With vertical front light inside the frame for perfect illumination.

Miroir avec cadre en aluminium laqué.. Avec lumière frontale verticale à l'intérieur du cadre pour un éclairage sans ombre.

Spiegel mit lackiertem Aluminiumrahmen. Mit vertikalem Frontlicht im Inneren des Rahmens für perfekte Ausleuchtung.

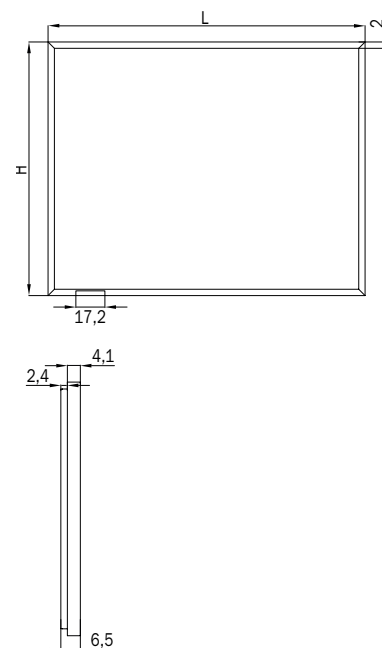

in foto: specchio nero con Antifog e Bluetooth
 in photo: black mirror with Antifog and Bluetooth
 sur la photo : miroir noir avec Antifog et Bluetooth
 im Bild: schwarzer Spiegel mit Antifog und Bluetooth:

S1921340AFBT.23**new**

| H mm. | L mm. | Sp mm. | Watt | L/MT | COD. | .09 | .23 | .32 | .55 | .35 |
|-------|-------|--------|------|------|----------|--------|--------|--------|-----|-----|
| 800 | 600 | 65 | 20 | 900 | S1921310 | 577,00 | 725,00 | 755,00 | | |
| 800 | 800 | 65 | 20 | 900 | S1921320 | 594,00 | 745,00 | 780,00 | | |
| 800 | 900 | 65 | 20 | 900 | S1921325 | 605,00 | 755,00 | 795,00 | | |
| 800 | 1000 | 65 | 20 | 900 | S1921330 | 618,00 | 775,00 | 815,00 | | |
| 800 | 1200 | 65 | 20 | 900 | S1921340 | 641,00 | 800,00 | 865,00 | | |
| 800 | 1400 | 65 | 20 | 900 | S1921350 | 652,00 | 815,00 | 895,00 | | |

| H mm. | L mm. | Sp mm. | Watt | L/MT | COD. | .09 | .23 | .32 | .55 | .35 |
|-------|-------|--------|------|------|------------|--------|---------|---------|-----|-----|
| 800 | 600 | 65 | 30 | 900 | S1921310BT | 877,00 | 1025,00 | 1055,00 | | |
| 800 | 800 | 65 | 30 | 900 | S1921320BT | 894,00 | 1045,00 | 1080,00 | | |
| 800 | 900 | 65 | 30 | 900 | S1921325BT | 905,00 | 1055,00 | 1095,00 | | |
| 800 | 1000 | 65 | 30 | 900 | S1921330BT | 918,00 | 1075,00 | 1115,00 | | |
| 800 | 1200 | 65 | 30 | 900 | S1921340BT | 941,00 | 1100,00 | 1165,00 | | |
| 800 | 1400 | 65 | 30 | 900 | S1921350BT | 952,00 | 1115,00 | 1195,00 | | |

new

| H mm. | L mm. | Sp mm. | Watt | L/MT | COD. | .09 | .23 | .32 | .55 | .35 |
|-------|-------|--------|------|------|------------|--------|--------|--------|-----|-----|
| 800 | 600 | 65 | 58 | 900 | S1921310AF | 647,00 | 795,00 | 825,00 | | |
| 800 | 800 | 65 | 75 | 900 | S1921320AF | 664,00 | 815,00 | 850,00 | | |
| 800 | 900 | 65 | 90 | 900 | S1921325AF | 675,00 | 825,00 | 865,00 | | |
| 800 | 1000 | 65 | 90 | 900 | S1921330AF | 708,00 | 865,00 | 905,00 | | |
| 800 | 1200 | 65 | 125 | 900 | S1921340AF | 731,00 | 890,00 | 955,00 | | |
| 800 | 1400 | 65 | 125 | 900 | S1921350AF | 742,00 | 905,00 | 985,00 | | |

| H mm. | L mm. | Sp mm. | Watt | L/MT | COD. | .09 | .23 | .32 | .55 | .35 |
|-------|-------|--------|------|------|--------------|---------|---------|---------|-----|-----|
| 800 | 600 | 65 | 68 | 900 | S1921310AFBT | 947,00 | 1095,00 | 1125,00 | | |
| 800 | 800 | 65 | 85 | 900 | S1921320AFBT | 964,00 | 1115,00 | 1150,00 | | |
| 800 | 900 | 65 | 100 | 900 | S1921325AFBT | 975,00 | 1125,00 | 1165,00 | | |
| 800 | 1000 | 65 | 100 | 900 | S1921330AFBT | 1008,00 | 1165,00 | 1205,00 | | |
| 800 | 1200 | 65 | 135 | 900 | S1921340AFBT | 1031,00 | 1190,00 | 1255,00 | | |
| 800 | 1400 | 65 | 135 | 900 | S1921350AFBT | 1042,00 | 1205,00 | 1285,00 | | |

ZENITH

Specchio senza telaio. Luce ambientale su 4 lati. Solo collegamento a rete.

Frameless mirror. Ambient light on 4 sides. Mains connection only.

Miroir sans cadre. Lumière d'ambiance sur 4 côtés. Branchement sur secteur uniquement.

Rahmenloser Spiegel. Umgebungslicht auf 4 Seiten. Nur Netzanschluss.

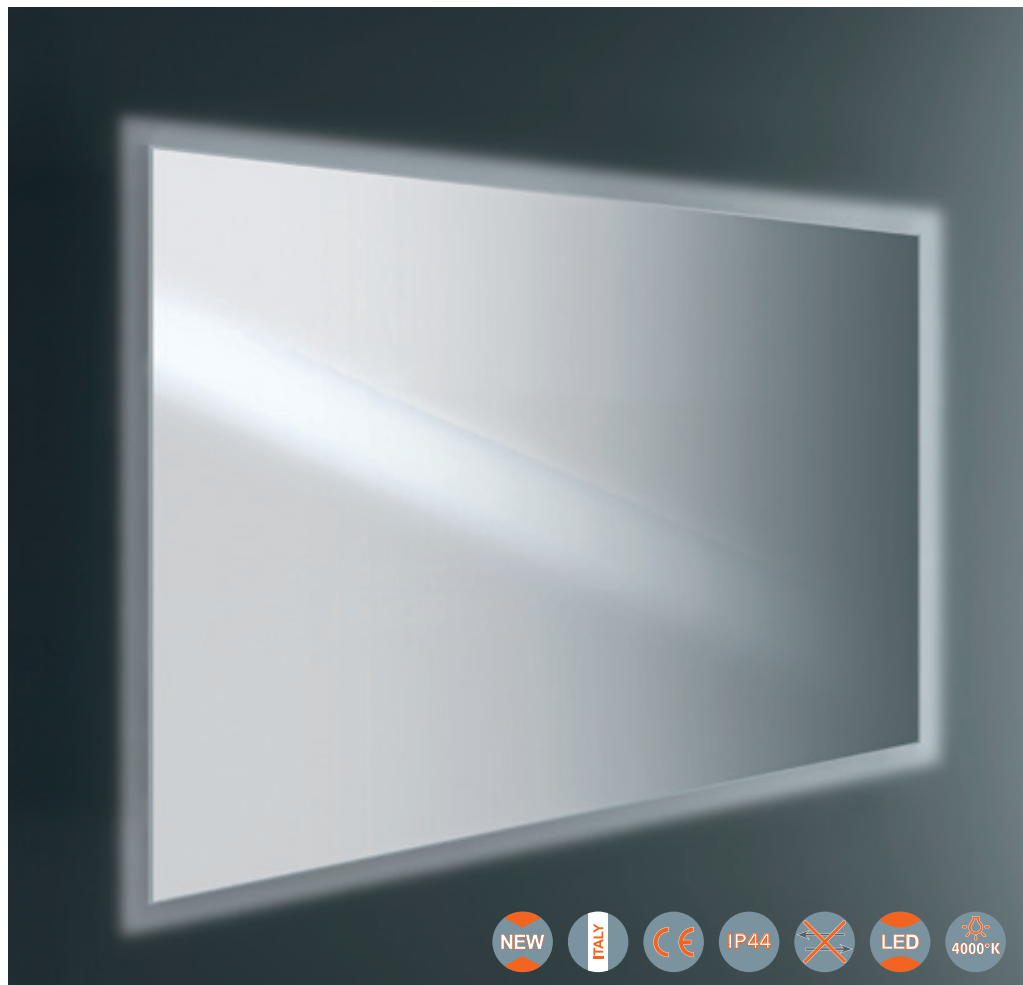

new

| H mm. | L mm. | Sp mm. | Watt | L/MT | COD. | € |
|-------|-------|--------|------|------|-----------------|--------|
| 800 | 600 | 30 | 30 | 1700 | S1210010 | 391,00 |
| 800 | 800 | 30 | 35 | 1700 | S1210020 | 413,00 |
| 800 | 900 | 30 | 38 | 1700 | S1210025 | 424,00 |
| 800 | 1000 | 30 | 40 | 1700 | S1210030 | 437,00 |
| 800 | 1200 | 30 | 45 | 1700 | S1210040 | 461,00 |
| 800 | 1400 | 30 | 50 | 1700 | S1210050 | 486,00 |

new

| H mm. | L mm. | Sp mm. | Watt | L/MT | COD. | € |
|-------|-------|--------|------|------|-------------------|--------|
| 800 | 600 | 30 | 85 | 1700 | S1210010AF | 461,00 |
| 800 | 800 | 30 | 90 | 1700 | S1210020AF | 483,00 |
| 800 | 900 | 30 | 93 | 1700 | S1210025AF | 494,00 |
| 800 | 1000 | 30 | 95 | 1700 | S1210030AF | 507,00 |
| 800 | 1200 | 30 | 100 | 1700 | S1210040AF | 531,00 |
| 800 | 1400 | 30 | 105 | 1700 | S1210050AF | 556,00 |



POLARIS

Specchio con telaio in alluminio verniciato. Luce ambientale superiore/inferiore.

Mirror with painted aluminium frame. Upper-lower ambient light.

Miroir avec cadre couleur aluminium satiné. Lumière d'ambiance supérieure-inférieure.

Spiegel mit lackiertem Aluminiumrahmen. Oberes / unteres Umgebungslicht.

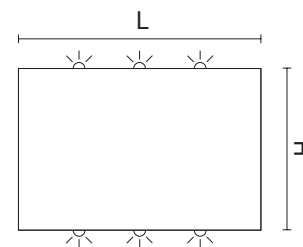
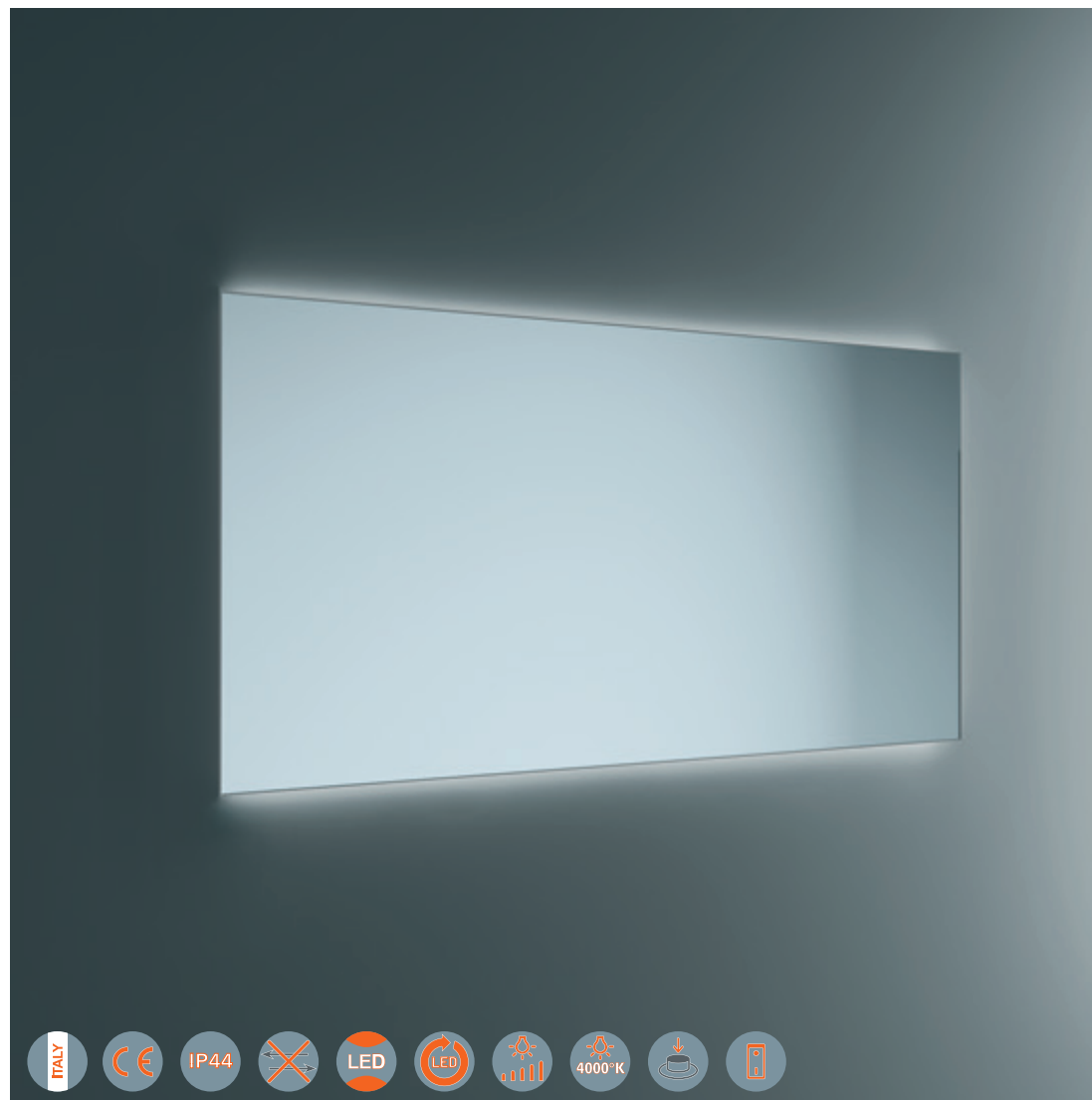

ZENITH

| H mm. | L mm. | SP mm. | Watt | Lumen/mt |
|-------|-------|--------|------|----------|
| 800 | 600 | 45 | 18 | 1700 |
| 800 | 700 | 45 | 21 | 1700 |
| 800 | 800 | 45 | 23 | 1700 |
| 800 | 900 | 45 | 25 | 1700 |
| 800 | 1000 | 45 | 27 | 1700 |
| 800 | 1100 | 45 | 29 | 1700 |
| 800 | 1200 | 45 | 31 | 1700 |
| 800 | 1300 | 45 | 34 | 1700 |
| 800 | 1400 | 45 | 36 | 1700 |

| COD. | .09 | .23 | .32 |
|--------------|-----|--------|-----|
| 58400 | | 382,00 | |
| 58406 | | 400,00 | |
| 58412 | | 436,00 | |
| 58418 | | 460,00 | |
| 58424 | | 475,00 | |
| 58430 | | 487,00 | |
| 58436 | | 506,00 | |
| 58442 | | 544,00 | |
| 58448 | | 555,00 | |



POLARIS

Specchio con telaio in alluminio verniciato. Luce ambientale laterale.

Mirror with painted aluminium frame. Side ambient light.

Miroir avec cadre couleur aluminium satiné. Lumière d'ambiance latérale.

Spiegel mit lackiertem Aluminiumrahmen. Oberes / unteres Umgebungslicht.

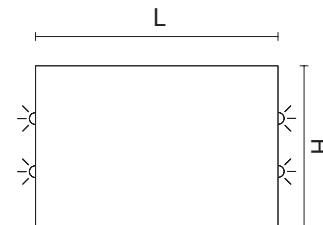
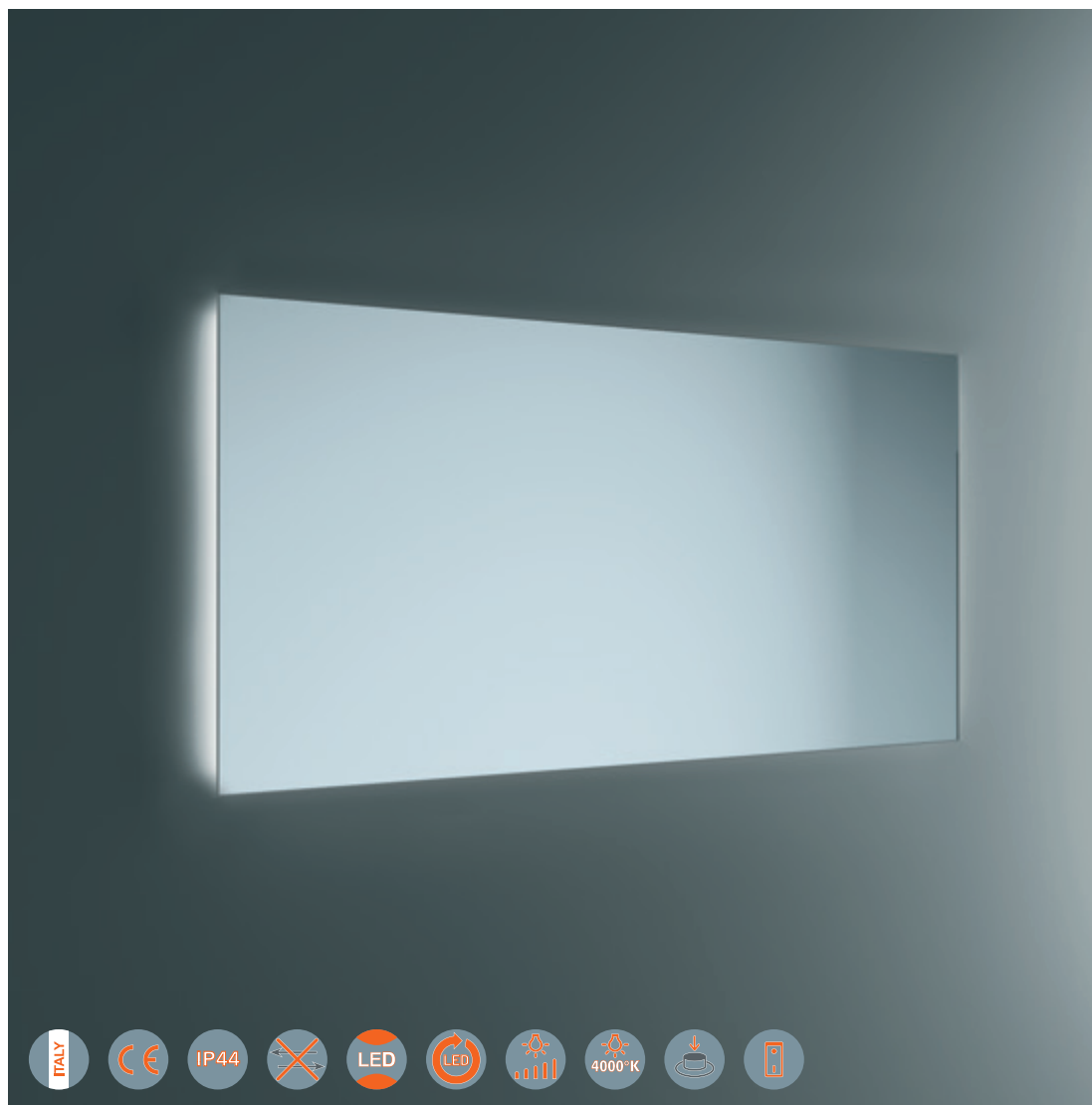

| H mm. | L mm. | SP mm. | Watt | Lumen/mt | COD. | .09 | .23 | .32 |
|-------|-------|--------|------|----------|--------------|-----|--------|-----|
| 800 | 600 | 45 | 23 | 1700 | 58402 | | 396,00 | |
| 800 | 700 | 45 | 23 | 1700 | 58408 | | 405,00 | |
| 800 | 800 | 45 | 23 | 1700 | 58414 | | 414,00 | |
| 800 | 900 | 45 | 23 | 1700 | 58420 | | 424,00 | |
| 800 | 1000 | 45 | 23 | 1700 | 58426 | | 434,00 | |
| 800 | 1100 | 45 | 23 | 1700 | 58432 | | 441,00 | |
| 800 | 1200 | 45 | 23 | 1700 | 58438 | | 453,00 | |
| 800 | 1300 | 45 | 23 | 1700 | 58444 | | 460,00 | |
| 800 | 1400 | 45 | 23 | 1700 | 58450 | | 465,00 | |



POLARIS

Specchio con telaio in colore alluminio verniciato. Luce ambientale su 4 lati.

Mirror with painted aluminium frame. Ambient light on 4 sides.

Miroir avec cadre couleur aluminium satiné. Lumière d'ambiance sur 4 côtés.

Spiegel mit lackiertem Aluminiumrahmen. Umgebungslicht an 4 Seiten.

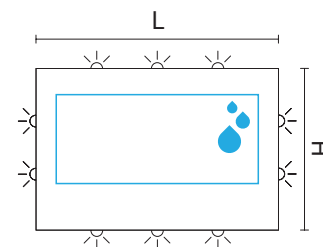

POLARIS

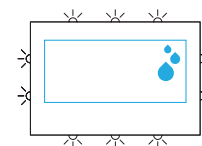
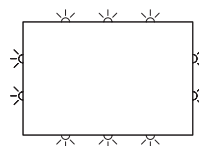

| H mm. | L mm. | SP mm. | Lumen/mt | COD. | Watt | .09 | .23 | .32 |
|-------|-------|--------|----------|--------------|------|--------|-----|-----|
| 800 | 600 | 45 | 900 | 58404 | 36 | 634,00 | | |
| 800 | 700 | 45 | 900 | 58410 | 38 | 653,00 | | |
| 800 | 800 | 45 | 900 | 58416 | 40 | 668,00 | | |
| 800 | 900 | 45 | 900 | 58422 | 42 | 704,00 | | |
| 800 | 1000 | 45 | 900 | 58428 | 44 | 722,00 | | |
| 800 | 1100 | 45 | 900 | 58434 | 47 | 733,00 | | |
| 800 | 1200 | 45 | 900 | 58440 | 49 | 753,00 | | |
| 800 | 1300 | 45 | 900 | 58446 | 51 | 792,00 | | |
| 800 | 1400 | 45 | 900 | 58452 | 53 | 804,00 | | |

| COD. | Watt | .09 | .23 | .32 |
|--------------|------|-----|--------|-----|
| 58405 | 74 | | 712,00 | |
| 58411 | 76 | | 731,00 | |
| 58417 | 95 | | 748,00 | |
| 58423 | 107 | | 798,00 | |
| 58429 | 109 | | 814,00 | |
| 58435 | 152 | | 826,00 | |
| 58441 | 154 | | 846,00 | |
| 58447 | 156 | | 884,00 | |
| 58453 | 158 | | 896,00 | |



EUROPA

Specchio con telaio in alluminio verniciato. Con luce frontale.

Mirror with painted aluminium frame. Front light.

Miroir avec cadre couleur aluminium satiné. Lumière supérieure.

Spiegel mit lackiertem Aluminiumrahmen. Oberes / unteres Umgebungslicht.

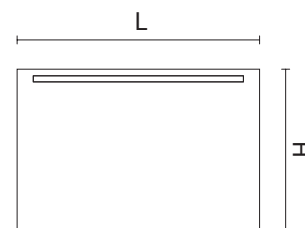
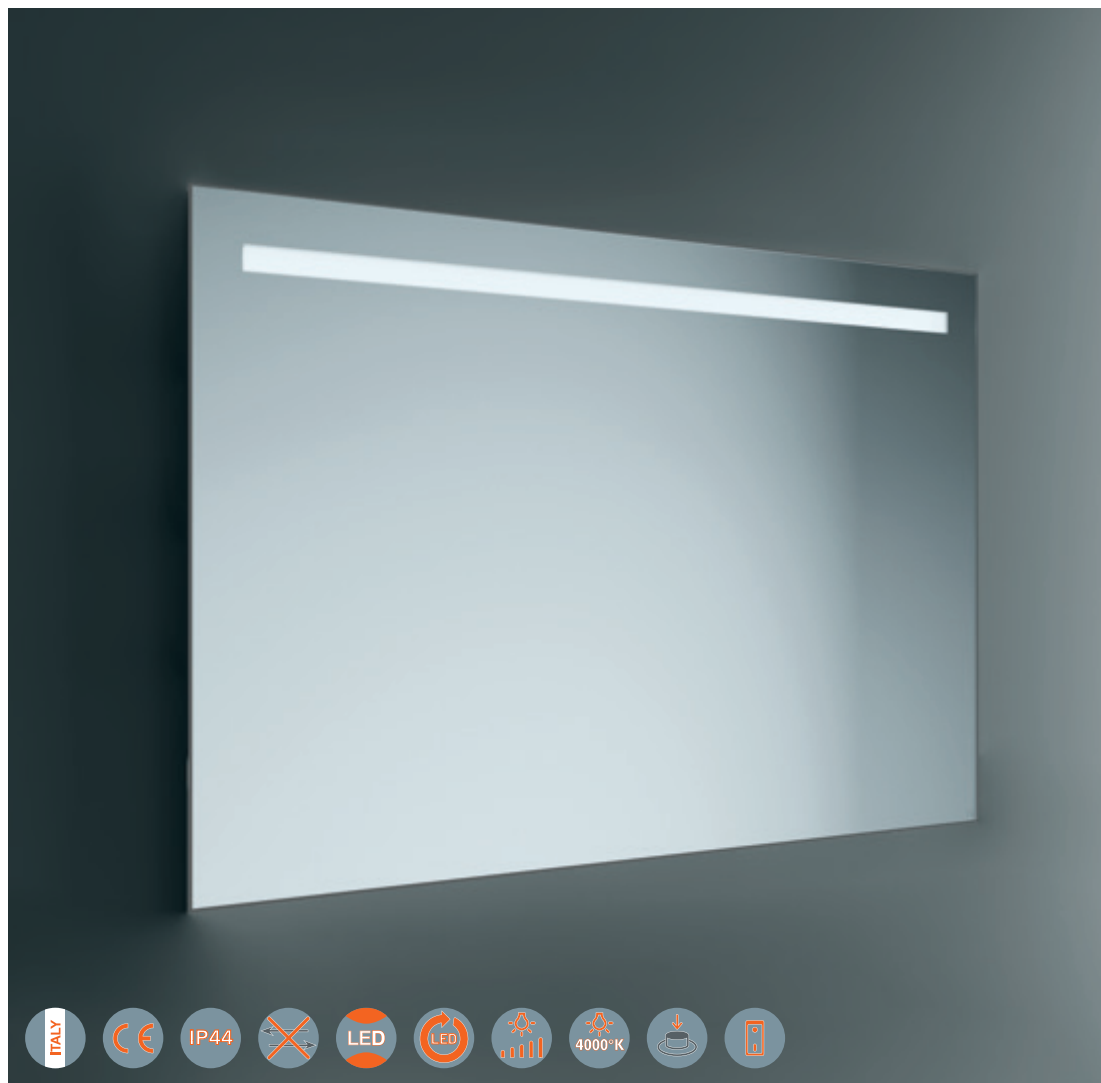

| H mm. | L mm. | SP mm. | Watt | Lumen/mt |
|-------|-------|--------|------|----------|
| 800 | 600 | 45 | 12 | 1700 |
| 800 | 700 | 45 | 13 | 1700 |
| 800 | 800 | 45 | 14 | 1700 |
| 800 | 900 | 45 | 15 | 1700 |
| 800 | 1000 | 45 | 16 | 1700 |
| 800 | 1100 | 45 | 17 | 1700 |
| 800 | 1200 | 45 | 18 | 1700 |
| 800 | 1300 | 45 | 20 | 1700 |
| 800 | 1400 | 45 | 21 | 1700 |

| COD. | .09 | .23 | .32 |
|--------------|-----|--------|-----|
| 58100 | | 336,00 | |
| 58104 | | 356,00 | |
| 58108 | | 373,00 | |
| 58112 | | 392,00 | |
| 58116 | | 412,00 | |
| 58120 | | 429,00 | |
| 58124 | | 448,00 | |
| 58128 | | 468,00 | |
| 58132 | | 485,00 | |

Specchio con telaio in alluminio verniciato. Luce frontale e ambientale superiore/inferiore.

Mirror with painted aluminium frame. Front and upper / lower ambient light.

Miroir avec cadre couleur aluminium satiné. Lumière supérieure et d'ambiance supérieure / inférieure.

Spiegel mit lackiertem Aluminiumrahmen. Umgebungslicht vorne und oben / unten.

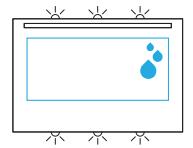
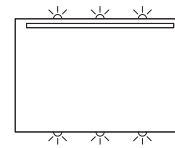
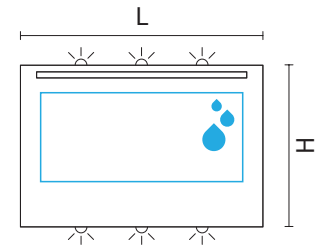

| H mm. | L mm. | SP mm. | Lumen/mt | COD. | Watt | .09 | .23 | .32 | COD. | Watt | .09 | .23 | .32 |
|-------|-------|--------|----------|--------------|------|--------|-----|-----|--------------|------|--------|-----|-----|
| 800 | 600 | 45 | 900 | 58102 | 25 | 595,00 | | | 58103 | 63 | 670,00 | | |
| 800 | 700 | 45 | 900 | 58106 | 28 | 623,00 | | | 58107 | 66 | 699,00 | | |
| 800 | 800 | 45 | 900 | 58110 | 31 | 647,00 | | | 58111 | 69 | 724,00 | | |
| 800 | 900 | 45 | 900 | 58114 | 35 | 681,00 | | | 58115 | 100 | 774,00 | | |
| 800 | 1000 | 45 | 900 | 58118 | 38 | 708,00 | | | 58119 | 103 | 801,00 | | |
| 800 | 1100 | 45 | 900 | 58122 | 41 | 741,00 | | | 58123 | 146 | 834,00 | | |
| 800 | 1200 | 45 | 900 | 58126 | 44 | 768,00 | | | 58127 | 149 | 861,00 | | |
| 800 | 1300 | 45 | 900 | 58130 | 48 | 818,00 | | | 58131 | 153 | 912,00 | | |
| 800 | 1400 | 45 | 900 | 58134 | 51 | 839,00 | | | 58135 | 156 | 932,00 | | |



ART

Specchio con telaio in alluminio verniciato. Con luce frontale.

Mirror with painted aluminium frame. Front light.

Miroir avec cadre couleur aluminium satiné. Lumières latérales.

Spiegel mit lackiertem Aluminiumrahmen. Oberes / unteres Umgebungslicht.

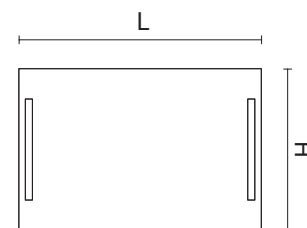

| H mm. | L mm. | SP mm. | Watt | Lumen/mt |
|-------|-------|--------|------|----------|
| 800 | 600 | 45 | 23 | 1700 |
| 800 | 700 | 45 | 23 | 1700 |
| 800 | 800 | 45 | 23 | 1700 |
| 800 | 900 | 45 | 23 | 1700 |
| 800 | 1000 | 45 | 23 | 1700 |
| 800 | 1100 | 45 | 23 | 1700 |
| 800 | 1200 | 45 | 23 | 1700 |
| 800 | 1300 | 45 | 23 | 1700 |
| 800 | 1400 | 45 | 23 | 1700 |

| COD. | .09 | .23 | .32 |
|--------------|-----|--------|-----|
| 58200 | | 436,00 | |
| 58204 | | 454,00 | |
| 58208 | | 473,00 | |
| 58212 | | 492,00 | |
| 58216 | | 510,00 | |
| 58220 | | 529,00 | |
| 58224 | | 548,00 | |
| 58228 | | 566,00 | |
| 58232 | | 585,00 | |



Specchio con telaio in alluminio verniciato. Luce frontale e ambientale superiore/inferiore.

Mirror with painted aluminium frame. Front and upper / lower ambient light.

Miroir avec cadre couleur aluminium satiné. Lumières latérales et d'ambiance supérieure / inférieure.

Spiegel mit lackiertem Aluminiumrahmen. Umgebungslicht vorne und oben / unten.

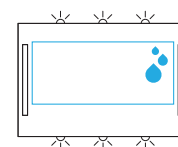
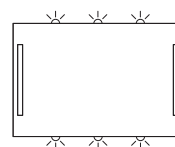
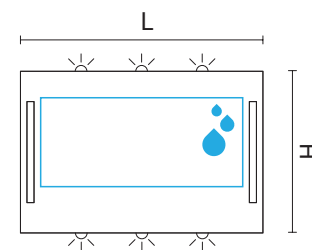

| H mm. | L mm. | SP mm. | Lumen/mt | COD. | Watt | .09 | .23 | .32 |
|-------|-------|--------|----------|--------------|------|--------|-----|-----|
| 800 | 600 | 45 | 900 | 58202 | 42 | 652,00 | | |
| 800 | 700 | 45 | 900 | 58206 | 45 | 678,00 | | |
| 800 | 800 | 45 | 900 | 58210 | 49 | 713,00 | | |
| 800 | 900 | 45 | 900 | 58214 | 52 | 746,00 | | |
| 800 | 1000 | 45 | 900 | 58218 | 55 | 772,00 | | |
| 800 | 1100 | 45 | 900 | 58222 | 58 | 792,00 | | |
| 800 | 1200 | 45 | 900 | 58226 | 62 | 821,00 | | |
| 800 | 1300 | 45 | 900 | 58230 | 65 | 870,00 | | |
| 800 | 1400 | 45 | 900 | 58234 | 68 | 890,00 | | |

| COD. | Watt | .09 | .23 | .32 |
|--------------|------|--------|-----|-----|
| 58203 | 80 | 728,00 | | |
| 58207 | 83 | 755,00 | | |
| 58211 | 104 | 792,00 | | |
| 58215 | 107 | 826,00 | | |
| 58219 | 120 | 866,00 | | |
| 58223 | 123 | 885,00 | | |
| 58227 | 167 | 914,00 | | |
| 58231 | 170 | 961,00 | | |
| 58235 | 173 | 983,00 | | |



ACRUX

Specchio con telaio in alluminio verniciato. Con luce frontale. Specchio ingranditore integrato.

Mirror with painted aluminium frame. With front light. Integrated magnifying mirror.

Miroir avec cadre en aluminium satiné. Avec éclairage frontal. Miroir grossissant intégré.

Spiegel mit lackiertem Aluminiumrahmen. Mit Frontlicht. Integrierter Vergrößerungsspiegel.

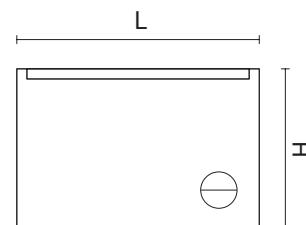

| H mm. | L mm. | SP mm. | Watt | Lumen/mt | COD. | .09 | .23 | .32 |
|-------|-------|--------|------|----------|--------------|-----|--------|-----|
| 800 | 600 | 45 | 12 | 1700 | 58300 | | 573,00 | |
| 800 | 700 | 45 | 13 | 1700 | 58304 | | 597,00 | |
| 800 | 800 | 45 | 14 | 1700 | 58308 | | 622,00 | |
| 800 | 900 | 45 | 15 | 1700 | 58312 | | 647,00 | |
| 800 | 1000 | 45 | 16 | 1700 | 58316 | | 672,00 | |
| 800 | 1100 | 45 | 17 | 1700 | 58320 | | 697,00 | |
| 800 | 1200 | 45 | 18 | 1700 | 58324 | | 722,00 | |
| 800 | 1300 | 45 | 20 | 1700 | 58328 | | 746,00 | |
| 800 | 1400 | 45 | 21 | 1700 | 58332 | | 771,00 | |



Specchio con telaio in alluminio verniciato. Luce frontale/ambientale sottospeschio. Specchio ingranditore integrato.

Mirror with painted aluminium frame. Front / ambient light under the mirror. Integrated magnifying mirror.

Miroir avec cadre en aluminium satiné. Lumière frontale / d'ambiance sous le miroir. Miroir grossissant intégré.

Spiegel mit lackiertem Aluminiumrahmen. Mit Frontlicht. Integrierter Vergrößerungsspiegel.

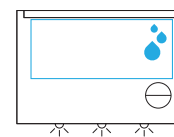
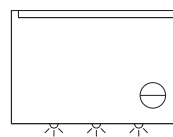
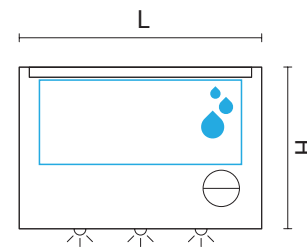

| H mm. | L mm. | SP mm. | Lumen/mt | COD. | Watt | .09 | .23 | .32 |
|-------|-------|--------|----------|--------------|------|-----|--------|-----|
| 800 | 600 | 45 | 900 | 58302 | 18 | | 601,00 | |
| 800 | 700 | 45 | 900 | 58306 | 21 | | 636,00 | |
| 800 | 800 | 45 | 900 | 58310 | 23 | | 669,00 | |
| 800 | 900 | 45 | 900 | 58314 | 25 | | 731,00 | |
| 800 | 1000 | 45 | 900 | 58318 | 27 | | 764,00 | |
| 800 | 1100 | 45 | 900 | 58322 | 29 | | 796,00 | |
| 800 | 1200 | 45 | 900 | 58326 | 31 | | 830,00 | |
| 800 | 1300 | 45 | 900 | 58330 | 34 | | 877,00 | |
| 800 | 1400 | 45 | 900 | 58334 | 36 | | 908,00 | |

| COD. | Watt | .09 | .23 | .32 |
|--------------|------|-----|---------|-----|
| 58303 | 56 | | 678,00 | |
| 58307 | 59 | | 713,00 | |
| 58311 | 61 | | 746,00 | |
| 58315 | 90 | | 823,00 | |
| 58319 | 92 | | 857,00 | |
| 58323 | 134 | | 889,00 | |
| 58327 | 136 | | 922,00 | |
| 58331 | 139 | | 969,00 | |
| 58335 | 141 | | 1002,00 | |



SPECI

Specchio luce LED cornice illuminata

Framed mirror with LED light / Miroir avec lumière LED / Spiegel mit LED Beleuchtung Rahmen

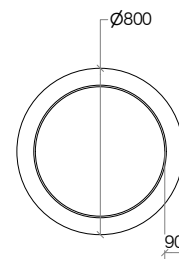
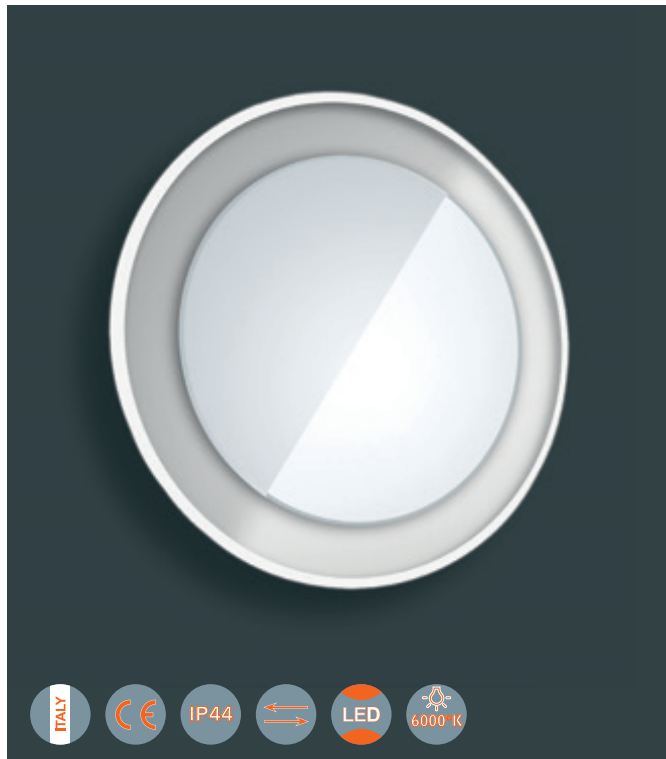

Specchio
Mirror
Miroir
Spiegel



| Watt | Lumen/mt | 5671 | |
|------|----------|------|--------|
| 26 | 1500 | € | 771,00 |

Specchio con luce LED, accensione a sensore touch con regolatore di luce

Mirror with LED lighting, touch sensor switch and dimmer
Miroir avec lumière LED, allumage par touch avec régulateur de lumière
Spiegel , Led Licht, Touch Einschalten, Lichtregler

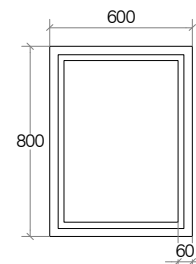
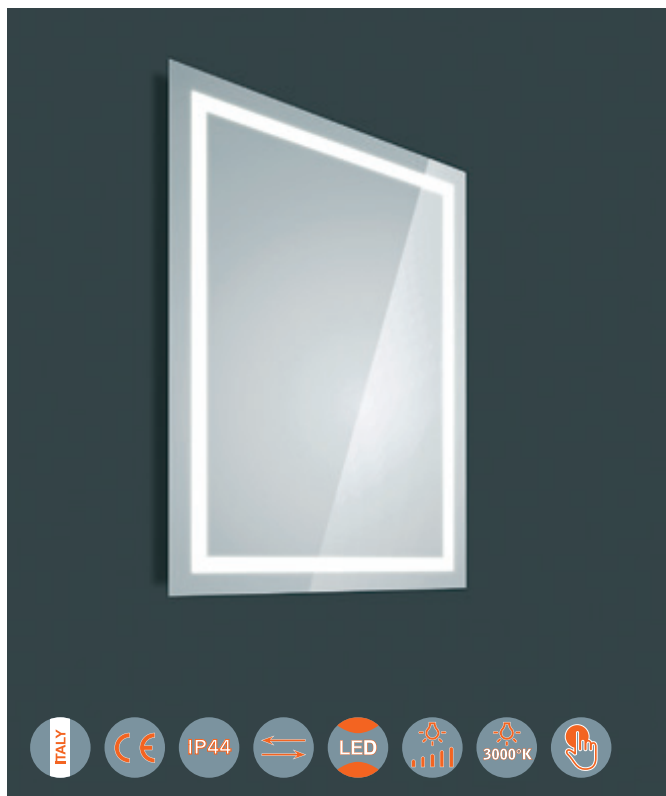

Specchio
Mirror
Miroir
Spiegel



| | | | |
|--|--|-------|--------|
| | | 56851 | |
| | | € | 380,00 |

SPECI

Specchio con luce LED

Mirror with LED light / Miroir avec lumière LED / Spiegel mit LED Beleuchtung

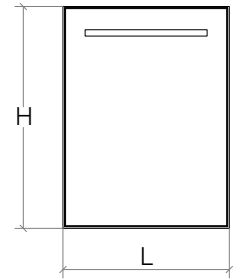

Specchio
Mirror
Miroir
Spiegel



| H mm. | L mm. | Sp mm. | Watt | Lumen/mt | Cod. | € |
|-------|-------|--------|------|----------|--------------|--------|
| 800 | 600 | 30 | 5 | 1400 | 56707 | 326,00 |
| 800 | 800 | 30 | 7 | 1400 | 56708 | 363,00 |
| 800 | 1000 | 30 | 9 | 1400 | 56709 | 405,00 |
| 800 | 1200 | 30 | 11 | 1400 | 56710 | 447,00 |

Specchio con luce LED e mensola

Mirror with LED lighting and shelf / Miroir avec étagère et lumière LED / Spiegel mit LED Licht und Ablage

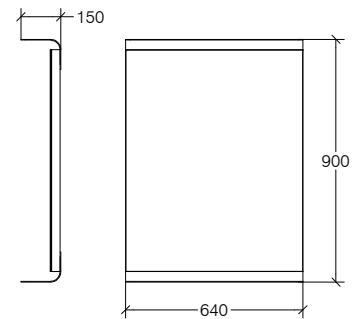

Verniciato bianco
White painted
Blanc laqué
Lackiertem Weiß

Verniciato nero
Black painted
Noir laqué
Lackiertem Schwarz



| Watt | Lumen/mt | 5689 | .09.WL | .23.WL |
|------|----------|------|--------|--------|
| 26 | 1050 | € | 612,00 | 612,00 |

OPEN

Specchio con cornice

Mirror with frame / Miroir avec encadrement / Spiegel mit Rahmen

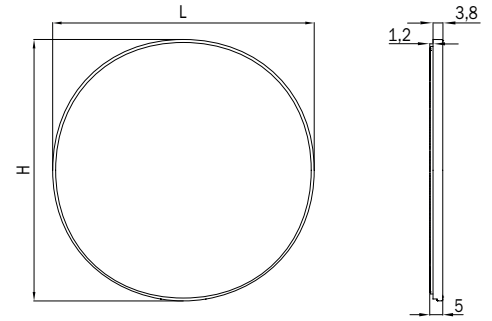

Verniciato bianco White painted / Blanc laqué / Lackiertem Weiß
Verniciato nero Black painted / Noir laqué / Lackiertem Schwarz
Verniciato sage Sage painted / Sage laqué / Lackiertem Sage
Verniciato ambra Ambra painted / Ambra laqué / Lackiertem Ambra



new

| H mm. | L mm. | Sp mm. | COD. | .09 | .23 | .73 | .86 |
|-------|-------|--------|-----------------|--------|--------|--------|--------|
| 620 | 620 | 50 | S1326210 | 450,00 | 450,00 | 540,00 | 540,00 |
| 820 | 820 | 50 | S1326220 | 556,00 | 556,00 | 668,00 | 668,00 |
| 1020 | 1020 | 50 | S1326230 | 665,00 | 665,00 | 800,00 | 800,00 |



Specchio con telaio

Mirror with frame / Miroir avec cadre / Spiegel mit Rahmen

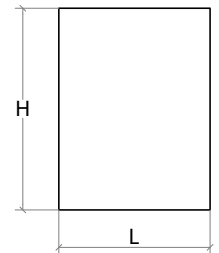

Verniciato bianco White painted / Blanc laqué / Lackiertem Weiß
Verniciato nero Black painted / Noir laqué / Lackiertem Schwarz
Alluminio verniciato Painted aluminium / Aluminium laqué / Lackiertem Aluminium



new



| H mm | L mm | Sp mm. | COD. | .09 | .23 | .32 |
|------|------|--------|--------------|--------|--------|--------|
| 960 | 400 | 30 | 56761 | 179,00 | 179,00 | 179,00 |
| 960 | 600 | 30 | 56762 | 213,00 | 213,00 | 213,00 |

SPECI

Specchio tondo

Round mirror / Miroir rond / Runder Spiegel

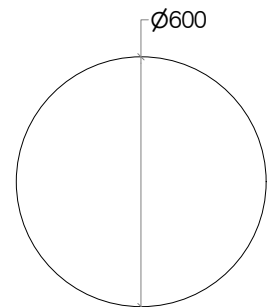

Specchio
Mirror
Miroir
Spiegel

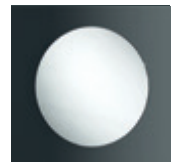

56300

€

173,00

OPEN

Specchio ovale reversibile

Reversible Oval mirror / Miroir oval réversible / Reversibeler Ovaler Spiegel

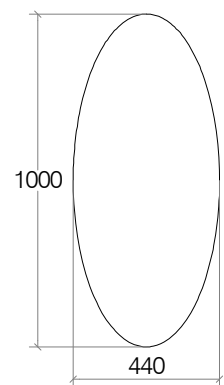
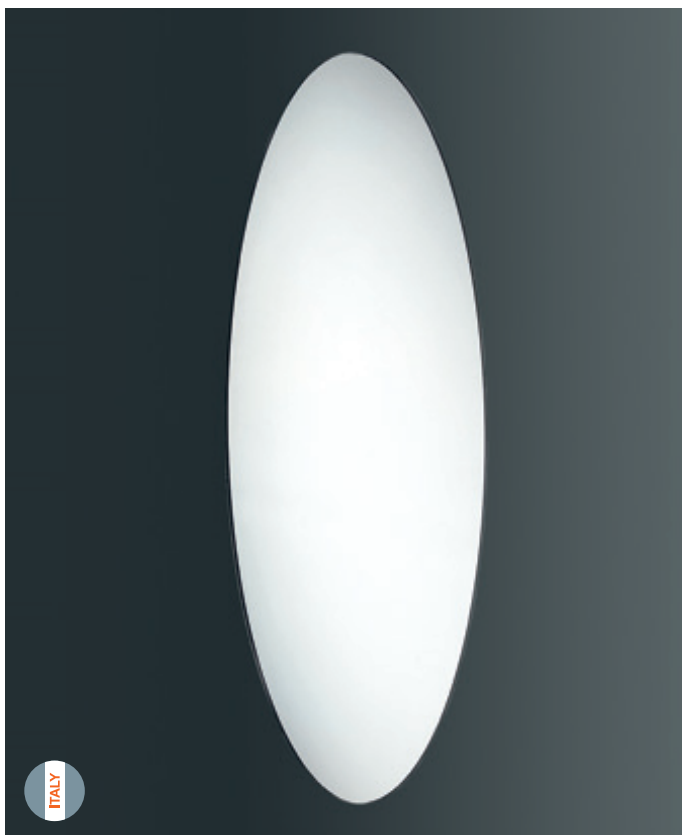

Specchio
Mirror
Miroir
Spiegel

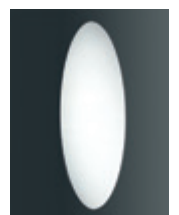

56301

€

192,00

SPECI

Specchio quadro

Square mirror / Miroir carré / Rechteckiger Spiegel

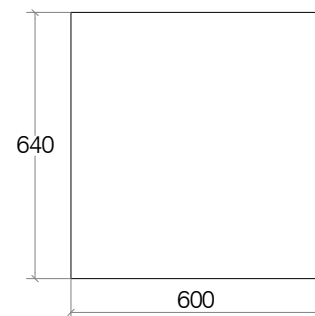

Specchio
Mirror
Miroir
Spiegel

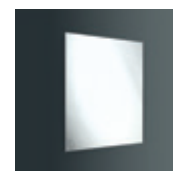

| | |
|--------------|--------|
| 56302 | |
| € | 143,00 |

Specchio reversibile

Reversible mirror / Miroir réversible / Reversibeler Spiegel

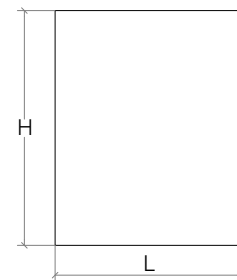

Specchio
Mirror
Miroir
Spiegel

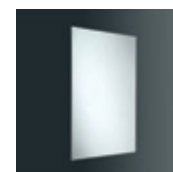

| H mm. | L mm. | Sp mm. | Cod. | € |
|-------|-------|--------|--------------|--------|
| 640 | 800 | 30 | 56303 | 151,00 |
| 640 | 900 | 30 | 56304 | 161,00 |
| 640 | 1000 | 30 | 56305 | 166,00 |
| 640 | 1200 | 30 | 56306 | 196,00 |
| 640 | 1300 | 30 | 56307 | 207,00 |

SPECI

Specchio molato

Grinding mirror / Miroir biseauté / Schleifspiegel

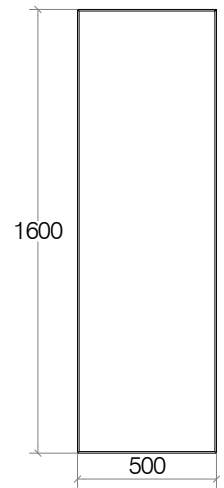
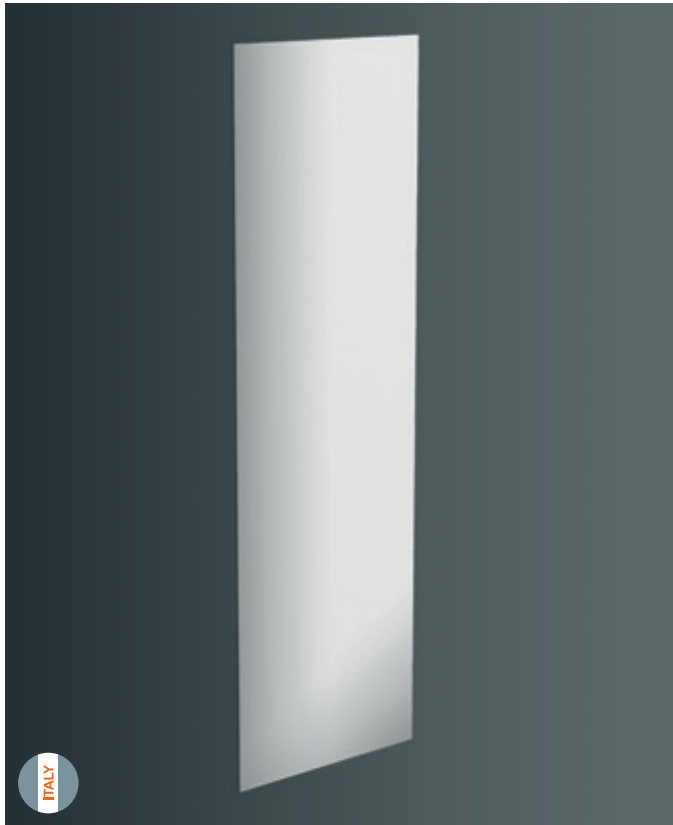

Specchio
Mirror
Miroir
Spiegel



56315

€

284,00

Specchio molato reversibile

Reversible mirror / Miroir réversible / Reversibeler Spiegel

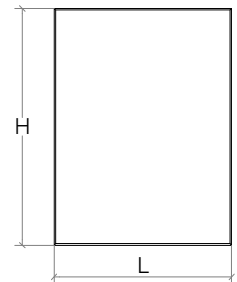

Specchio
Mirror
Miroir
Spiegel

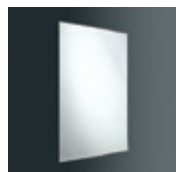

| H mm. | L mm. | Sp mm. | Cod. | € |
|-------|-------|--------|-------|--------|
| 640 | 600 | 30 | 56308 | 184,00 |
| 640 | 800 | 30 | 56309 | 192,00 |
| 640 | 900 | 30 | 56310 | 205,00 |
| 640 | 1000 | 30 | 56311 | 218,00 |
| 640 | 1200 | 30 | 56312 | 254,00 |
| 640 | 1300 | 30 | 56313 | 267,00 |
| 640 | 450 | 30 | 56314 | 167,00 |

SPECI

Specchio rotante filo lucido con fissaggio da piano, lato posteriore in acciaio inox

Revolving polished sides mirror with top fixing, back side in stainless steel

Miroir pivotant, fixation au sol, arrière en acier

Drehbarer Spiegel für Tisch Montage, Rückseite auf Edelstahl

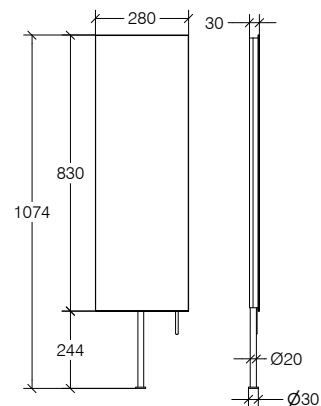

Specchio
Mirror
Miroir
Spiegel



56683

€

354,00

SPECI**Specchio filo lucido orientabile**

Adjustable mirror / Miroir orientable / Verstellbar Spiegel

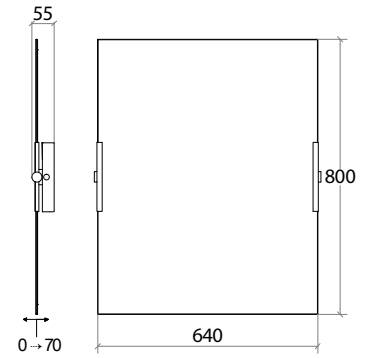

Specchio
Mirror
Miroir
Spiegel



| | |
|--------------|------------|
| 56685 | .29 |
| € | 336,00 |

SPECI

Lampade

Lamps / Lampes / Lampen

CIARI:

sono le luci. Della strada, della casa, ma anche i fari delle auto.

Collezione di lampade a led, ad alta efficienza luminosa. Disponibili a muro, sospese o a specchio.

EN

Ciari:

lights. In the street, inside the house, but also the headlights of the cars.

A collection of LED lamps, with high luminous efficiency. Available for wall installation, suspended or for mirrors.

Chromed aluminium or embossed white or black painted steel

FR

Ciari :

ce sont les lumières. De la rue, de la maison, mais aussi les phares des voitures.

Collection de lampes à LED, à grande intensité lumineuse. Disponibles en version murale, suspendue ou pour miroir.

Aluminium chromé ou acier verni blanc ou noir gaufré

DE

Ciari:

sind die Leuchten. Die Leuchten der Straße, des Hauses, aber auch die Autoscheinwerfer.

Kollektion aus LED-Lampen mit hoher Lichtausbeute. Erhältlich für die Wand, hängend oder mit Spiegel.

Verchromtes Aluminium oder weiß oder schwarz lackierter, gaufrierter Stahl

Finiture, Finishes-Finitions-Ausführung:

Alluminio cromato

Chromed aluminium
Aluminium chromé
Verchromtes Aluminium



.29

Alluminio bianco opaco

Matt white aluminium
Aluminium blanc mat
Matt Weiß Aluminium

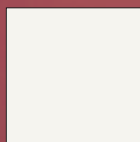

.09

Alluminio nero goffrato

Goffering black aluminium
Aluminium noir gaufré
Geprägtes Schwarz Aluminium



.18

Alluminio nero opaco

Matt black aluminium
Aluminium noir mat
Matt Schwarz Aluminium



.23

Lampada con fissaggio a parete, a specchio e a telaio

Lamp with wall, mirror and frame fixing / Lampe avec fixation murale, sur miroir et sur cadre / Lampe für Wand-, Spiegel- und Rahmenbefestigung

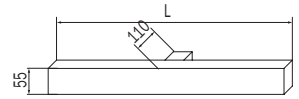

| L | WATT | LUMEN/MT |
|-----|------|----------|
| 300 | 6 | 460 |
| 500 | 8 | 568 |

| COD. | .09 | .23 | .29 | .32 |
|-------------|--------|--------|--------|--------|
| 5733 | 144,00 | 144,00 | 144,00 | 144,00 |
| 5734 | 186,00 | 186,00 | 186,00 | 186,00 |

ABS verniciato
Painted ABS
ABS laqué
Lackiertem ABS

ABS verniciato
Painted ABS
ABS laqué
Lackiertem ABS

ABS cromato
Chromed ABS
ABS chromé
Verchromtes ABS

ABS spazzolato
Brushed ABS
ABS brossé
Gebürstet ABS

Lampada LED a specchio

LED lamp to fix on mirror / Lampe LED pour miroir / Spiegelleuchte LED



| Watt | Watt | 5720 | .29 |
|------|------|-------------|------------|
| 3 | 200 | € | 103,00 |

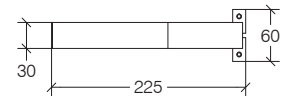
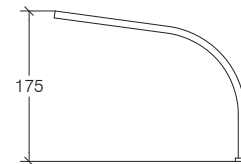

Ottone cromato
Chromed brass
Laiton chromé
Verchromtes Messing

**Lampada LED a specchio**

LED lamp to fix on mirror / Lampe LED pour miroir / Spiegelleuchte LED



| Watt | Watt | 5721 | .29 |
|------|------|-------------|------------|
| 3 | 200 | € | 103,00 |

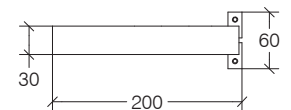
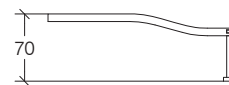

Ottone cromato
Chromed brass
Laiton chromé
Verchromtes Messing



CIARI

Lampada LED a specchio

LED lamp to fix on mirror / Lampe LED pour miroir / Spiegelleuchte LED

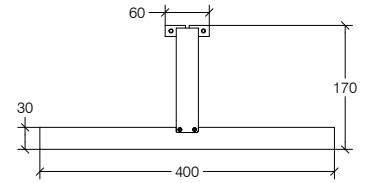
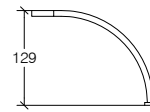

Ottone cromato
Chromed brass
Laiton chromé
Verchromtes Messing



| Watt | Watt | 5723 | .29 |
|------|------|------|--------|
| 6 | 400 | € | 123,00 |

Lampada LED applique a parete reversibile

Reversible LED wall lamp / Lampe LED mural réversible / Reversibeler LED-Wandleuchte

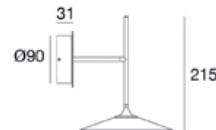

Verniciato bianco
White painted
Blanc laqué
Lackiertem Weiß

Verniciato nero
Black painted
Noir laqué
Lackiertem Schwarz



| Watt | Watt | 5729 | .09 | .18 |
|------|------|------|--------|--------|
| 7 | 600 | € | 188,00 | 188,00 |

Lampada LED applique a parete con luce orientabile

Wall LED lamp with light swivelling / Lampe LED murale avec lumière orientable / LED-Wandleuchte mit licht Schwenkbarkeit

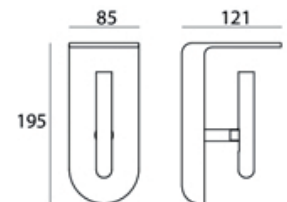

Verniciato bianco
White painted
Blanc laqué
Lackiertem Weiß

Verniciato nero
Black painted
Noir laqué
Lackiertem Schwarz



| Watt | Watt | 5732 | .09 | .23 |
|------|------|------|--------|--------|
| 4 | 363 | € | 355,00 | 355,00 |

CIARI

Lampada LED sospensione a soffitto

Pendant LED lamp / Lampe LED à suspendre / Hängende LED-Lampe



Verniciato nero
Black painted
Noir laqué
Lackiertem Schwarz



| Watt | Watt | 5731 | .18 |
|------|------|------|--------|
| 16 | 553 | € | 606,00 |

Lampada LED sospensione a soffitto

Pendant LED lamp / Lampe LED à suspendre / Hängende LED-Lampe

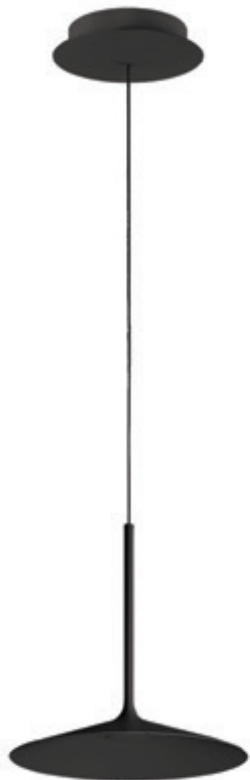

Verniciato bianco
White painted
Blanc laqué
Lackiertem Weiß

Verniciato nero
Black painted
Noir laqué
Lackiertem Schwarz



| Watt | Watt | 5730 | .09 | .18 |
|------|------|------|--------|--------|
| 7 | 600 | € | 163,00 | 163,00 |

**CODICE IP (EN 60529)**

Sistema che indica i gradi di protezione di un involucro contro l'accesso a parti pericolose, la penetrazione di corpi solidi, e/o l'ingresso di acqua.

PROTEZIONE CONTRO L'INGRESSO DI SOLIDI

IP0X non protetto

IP1X contro corpi estranei > 50 mm

IP2X contro corpi estranei > 12 mm

IP3X contro corpi estranei > 2,5 mm
IP4X contro corpi estranei > 1 mm

IP5X protezione da polvere

IP6X stagno alla polvere

PROTEZIONE CONTRO L'INGRESSO DI LIQUIDI

IPX0 non protetto

IPX1 contro la caduta vertical di gocce

IPX2 contro caduta acqua con inclinazione 15°

IPX3 contro la pioggia

IPX4 contro gli spruzzi

IPX5 contro i getti acqua

IPX6 contro i getti potenti

IPX7 contro l'immersione temporanea

IPX8 contro l'immersione continua

CLASSI DI ISOLAMENTO**⊕ CLASSE I**

La protezione non si basa unicamente sull'isolamento principale, ma anche su una misura di sicurezza supplementare costituita dalla connessione delle parti conduttrici accessibili ad un conduttore di protezione (messa a terra di protezione) che fa capo all'impianto elettrico fisso, in modo tale che le parti conduttrici accessibili non possano andare in tensione in caso di guasto dell'isolamento principale.

□ CLASSE II

Gli apparecchi di classe II sono progettati in modo da non richiedere la connessione di messa a terra. Sono costruiti in modo che un singolo guasto non possa causare il contatto con tensioni pericolose da parte dell'utilizzatore. Ciò è ottenuto realizzando l'involucro del contenitore in materiali isolanti, o comunque facendo in modo che le parti in tensione siano circondate da un doppio strato di materiale isolante o usando isolamenti rinforzati.

⊓ CLASSE III

Un apparecchio viene definito di Classe III quando la protezione contro la folgorazione si affida al fatto che non sono presenti tensioni superiori alla Bassissima tensione di sicurezza SELV (Safety Extra-Low Voltage). In pratica tale apparecchio viene alimentato o da una batteria o da un trasformatore SELV.

CE NORMATIVE TECNICHE

Le direttive 89/336/CEE e 73/23/CEE stabiliscono i requisiti essenziali di sicurezza e compatibilità elettromagnetica a cui devono rispondere i materiali elettrici per poter circolare liberamente all'interno del mercato Europeo. Questi requisiti devono essere verificati mediante opportune prove tecniche e la conformità del materiale deve essere indicata mediante l'apposizione del marchio CE sul prodotto o sul suo imballo. La marchiatura è obbligatoria ed il produttore è direttamente responsabile della rispondenza del prodotto ai requisiti essenziali delle direttive sopracitate. La vendita, la commercializzazione e l'acquisto di prodotti privi della marchiatura, e quindi non rispondenti alle direttive, è punita a termini di legge.

ZONE DI SICUREZZA

Tutti gli apparecchi elettrici vanno collegati al circuito mantenendo una distanza minima di 0,60 m da lavabi, cabine doccia, vasche e 1,20 m da soffioni doccia.

**IP CODE (EN 60529)**

A coding system to indicate the degree of protection provided by an enclosure against accessing of solid foreign objects and/or water.

PROTECTION AGAINST THE INGRESS OF SOLIDS

IP0X not protected

IP1X against solid foreign objects > 50 mm

IP2X against solid foreign objects > 12 mm

IP3X against solid foreign objects > 2,5 mm
IP4X against solid foreign objects > 1 mm

IP5X dust protected

IP6X dust-tight

PROTECTION AGAINST THE INGRESS OF LIQUIDS

IPX0 not protected

IPX1 against vertically dripping

IPX2 against 15° tilted dripping

IPX3 rain protected

IPX4 splashing protected

IPX5 jetting protected

IPX6 powerful jetting protected

IPX7 against temporary immersion

IPX8 against continuous immersion

CLASS LUMINAIRES**⊕ CLASSE I**

Provide protection against electrical shock solely using the base insulation and the safe connection of all exposed conductive parts to an earth conductor.

□ CLASSE II

Provide protection against electrical shock using both the base insulation and an additional or reinforced insulation. This kind of products do not feature a connection to a protective earth conductor.

⚡ CLASSE III

Luminaires provide protection against electrical shock by using Safety Extra Low Voltage (SELV). This kind of products are not permitted to generate higher voltages than the Safety Extra Low Voltage.

CE NORMATIVE NOTES

The directives 89/336/EEC and 73/23/EEC establish the essential requirements for safety and electromagnetic compatibility that the electric and electronic equipment shall comply for freely circulating in the European market. These requirements must be verified by appropriate tests and compliance of the material must be indicated by the CE marking on the product or its packaging. This marking is mandatory and the producer is directly responsible for product compliance with the essential requirements of the abovementioned Directives. The sale, marketing and purchase of products without the markup, and therefore not meet the guidelines, shall be punished by law.

SAFETY ZONES

Electric appliances must be wired to the electric circuit in a minimum distance of 0,60 m from shower cabins, bath tubs, washbasins and of 1,20 m from shower heads.

**CODE IP (EN 60529)**

Label qui indique les degrés de protection d'un emballage contre l'accès à des parties dangereuses, la pénétration de corps solides, et/ou la pénétration de l'eau.

PROTECTION CONTRE LA PÉNÉTRATION DE SOLIDES

IP0X non protégé

IP1X contre les corps étrangers > 50 mm

IP2X contre les corps étrangers > 12 mm

IP3X contre les corps étrangers > 2,5 mm
IP4X contre les corps étrangers > 1 mm

IP5X protection contre la poussière

IP6X étanche à la poussière

PROTECTION CONTRE LA PÉNÉTRATION DE LIQUIDES

IPX0 non protégé

IPX1 contre la chute verticale de gouttes

IPX2 contre la chute d'eau à 15° d'inclinaison

IPX3 contre la pluie

IPX4 contre les éclaboussures

IPX5 contre les jets d'eau

IPX6 contre les jets puissants

IPX7 contre l'immersion temporaire

IPX8 contre l'immersion continue

CLASSES D'ISOLATION**⊕ CLASSE I**

La protection n'est pas seulement basée sur l'isolation principale, mais également sur une mesure de sécurité supplémentaire constituée de la connexion des parties conductrices accessibles à un conducteur de protection (protection vers la terre) qui est rattaché à l'installation électrique fixe, de sorte que les parties conductrices accessibles ne puissent être mises sous tension en cas de panne de l'isolation principale.

□ CLASSE II

Les dispositifs de classe II sont conçus de sorte à ne pas avoir besoin de connexion à la terre. Ils sont fabriqués de façon à ce qu'une simple panne ne puisse causer le contact avec des tensions dangereuses de la part de l'utilisateur. Ce résultat est obtenu en fabriquant l'enveloppe du conteneur en matériau isolant, ou, en tout état de fait, en faisant en sorte que les parties sous tension soit entourées d'une double couche de matériau isolant, ou en utilisant une isolations renforcées.

⚡ CLASSE III

Un appareil est défini de Classe III lorsque sa protection contre l'électrocution est due au fait qu'aucune tension supérieure à la tension basse de sécurité SELV (Safety Extra-Low Voltage) n'est présente. Dans la pratique, cet appareil est alimenté soit par une batterie, soit par un transformateur SELV.

CE RÉGLEMENTATIONS TECHNIQUES

Les directives 89/336/CEE et 73/23/CEE établissent les exigences essentielles de sécurité et compatibilité électromagnétique auxquelles doivent répondre les matériaux électriques afin de pouvoir circuler librement sur le marché européen. Ces exigences doivent être vérifiées par des tests techniques appropriés et la conformité du matériau doit être indiquée par l'apposition de la marque CE sur le produit ou sur son emballage. Le marquage est obligatoire et le producteur est directement responsable de l'adéquation du produit aux exigences essentielles des directives susmentionnées. La vente, la commercialisation et l'achat de produits privés de ce marquage, et donc ne répondant pas aux directives, est puni en terme de loi.

ZONE DE SÉCURITÉ

Tous les appareils électriques sont reliés au circuit en maintenant une distance minimale de 0,60 m des lavabos, cabines de douche, baignoires et de 1,20 m des pommeaux de douche.

**IP CODE (EN 60529)**

System, das den Grad der Schutzklasse für den Zugang zu gefährlichen Teilen anzeigt, um das Eindringen von Festkörpern und / oder das Eindringen von Wasser zu verhindern.

SCHUTZ VOR DEM EINDRINGEN VON FESTSTOFFEN

IPOX ungeschützt

IP1X gegen Fremdkörper > 50 mm

IP2X gegen Fremdkörper > 12 mm

IP3X gegen Fremdkörper > 2,5 mm
IP4X gegen Fremdkörper > 1 mm

IP5X Schutz vor Staub

IP6X staubdicht

SCHUTZ VORM EINDRINGEN VON FLÜSSIGKEITEN

IPX0 ungeschützt

IPX1 gegen den vertikalen Fall von Tropfen

IPX2 gegen fallende Wasser mit 15 ° Neigung

IPX3 gegen Regen

IPX4 gegen Spritzer

IPX5 gegen Strahlwasser

IPX6 gegen starken Strahl

IPX7 gegen zeitweiliges Untertauchen

IPX8 gegen dauerndes Untertauchen

ISOLIERKLASSEN**⊥ KLASSE I**

Der Schutz basiert nicht nur auf der Hauptisolation, sondern auch auf einer zusätzliche Sicherheitsmaßnahme durch die Verbindung der leitenden Teile über einem Schutzleiter (geerdet), der zur feststehenden elektrischen Installation gehört, in der Weise, dass leitfähige Teile nicht unter Spannung gesetzt werden, falls es zu einem Ausfall der Hauptisolation kommt.

□ KLASSE II

Die Klasse-II-Geräte sind so konzipiert, damit sie keine Masseverbindung benötigen. Sie sind so konstruiert, dass ein einzelner Fehler nicht zum Kontakt mit gefährlichen Spannungen für den Benutzer führt. Dies wird durch die Konzeption des Behältermantels in Isoliermaterialien erreicht, oder auf andere Weise, so dass die stromführenden Teile durch eine Doppelschicht aus isolierendem Material oder durch Verwendung von verstärkter Isolierung umgeben sind.

⊠ KLASSE III

Eine Einheit ist definiert als Klasse III, wenn der Schutz gegen elektrischen Schlag auf der Tatsache beruht, dass die Spannungen nur als sehr niedrige Sicherheitsspannungen SELV (Extra Low Voltage Safety) anliegen. In der Praxis wird dies durch eine Batterie oder durch einen SELV Transformator sichergestellt.

CE TECHNISCHE STANDARDS

Richtlinien 89/336 / EWG und 73/23 / EWG Festlegung der grundlegenden Sicherheitsanforderungen und EMV-Anforderungen für elektrische Materialien auf dem europäischen Markt. Diese Anforderungen müssen durch geeignete technische Tests und die Konformität des Materials überprüft werden, und werden angezeigt durch das CE-Zeichen auf dem Produkt oder der Verpackung. Die Kennzeichnung ist obligatorisch und der Hersteller ist direkt verantwortlich für die Produktkonformität mit den grundlegenden Anforderungen der oben genannten Richtlinien. Der Vertrieb, Marketing und der Kauf von Produkten ohne Beschriftung ist daher nicht im Einklang mit Richtlinien und strafbar.

SICHERHEITSSZONE

Alle elektrischen Geräte werden mit der Schaltung verbunden, indem ein Mindestabstand von 0,60 m von Waschbecken gehalten wird, von Duschkabinen und Badewannen und 1,20 m von Duschköpfen.

Ricambi / Spare parts / Pièces détachées / Ersatzteile

| | | | |
|--------------|-----------|--|-------|
| 5689 | R2256202 | Minuterie per specchi - Hardware for mirror | 8,00 |
| | R28112 | Strip LED - LED strip | 71,00 |
| 5720 | R28200 | Driver 3W - 3W driver | 30,00 |
| | R28110 | Strip LED 3W - 3W LED strip | 25,00 |
| 5721 | R28200 | Driver 3W - 3W driver | 30,00 |
| | R28110 | Strip LED 3W - 3W LED strip | 25,00 |
| 5722 | R28201 | Driver 6W - 6W driver | 38,00 |
| | R28111 | Lampadina LED 6W - 6W LED lamp | 44,00 |
| 5723 | R28201 | Driver 6W - 6W driver | 38,00 |
| | R28111 | Lampadina LED 6W - 6W LED lamp | 44,00 |
| 56300 | R22563001 | Minuterie specchi 1 gancio + 2 viti - Hardware 1 hook + 2 screws | 12,00 |
| | R22563003 | Minuterie specchi distanziale maschio/femmina - Male/female mirror spacers | 10,00 |
| 56301 | R22563001 | Minuterie specchi 1 gancio + 2 viti - Hardware 1 hook + 2 screws | 12,00 |
| | R22563003 | Minuterie specchi distanziale maschio/femmina - Male/female mirror spacers | 10,00 |
| 56302 | R22563001 | Minuterie specchi 1 gancio + 2 viti - Hardware 1 hook + 2 screws | 12,00 |
| | R22563003 | Minuterie specchi distanziale maschio/femmina - Male/female mirror spacers | 10,00 |
| 56303 | R22563001 | Minuterie specchi 1 gancio + 2 viti - Hardware 1 hook + 2 screws | 12,00 |
| | R22563003 | Minuterie specchi distanziale maschio/femmina - Male/female mirror spacers | 10,00 |
| 56304 | R22563001 | Minuterie specchi 1 gancio + 2 viti - Hardware 1 hook + 2 screws | 12,00 |
| | R22563003 | Minuterie specchi distanziale maschio/femmina - Male/female mirror spacers | 10,00 |
| 56305 | R22563001 | Minuterie specchi 1 gancio + 2 viti - Hardware 1 hook + 2 screws | 12,00 |
| | R22563003 | Minuterie specchi distanziale maschio/femmina - Male/female mirror spacers | 10,00 |
| 56306 | R22563001 | Minuterie specchi 1 gancio + 2 viti - Hardware 1 hook + 2 screws | 12,00 |
| | R22563003 | Minuterie specchi distanziale maschio/femmina - Male/female mirror spacers | 10,00 |
| 56307 | R22563001 | Minuterie specchi 1 gancio + 2 viti - Hardware 1 hook + 2 screws | 12,00 |
| | R22563003 | Minuterie specchi distanziale maschio/femmina - Male/female mirror spacers | 10,00 |
| 56308 | R22563001 | Minuterie specchi 1 gancio + 2 viti - Hardware 1 hook + 2 screws | 12,00 |
| | R22563003 | Minuterie specchi distanziale maschio/femmina - Male/female mirror spacers | 10,00 |
| 56309 | R22563001 | Minuterie specchi 1 gancio + 2 viti - Hardware 1 hook + 2 screws | 12,00 |
| | R22563003 | Minuterie specchi distanziale maschio/femmina - Male/female mirror spacers | 10,00 |
| 56310 | R22563001 | Minuterie specchi 1 gancio + 2 viti - Hardware 1 hook + 2 screws | 12,00 |
| | R22563003 | Minuterie specchi distanziale maschio/femmina - Male/female mirror spacers | 10,00 |

Spare parts / Pièces détachées / Ersatzteile / **Ricambi**

| | | | |
|--------------|-----------|--|-------|
| 56311 | R22563001 | Minuterie specchi 1 gancio + 2 viti - Hardware 1 hook + 2 screws | 12,00 |
| | R22563003 | Minuterie specchi distanziale maschio/femmina - Male/female mirror spacers | 10,00 |
| 56312 | R22563001 | Minuterie specchi 1 gancio + 2 viti - Hardware 1 hook + 2 screws | 12,00 |
| | R22563003 | Minuterie specchi distanziale maschio/femmina - Male/female mirror spacers | 10,00 |
| 56313 | R22563001 | Minuterie specchi 1 gancio + 2 viti - Hardware 1 hook + 2 screws | 12,00 |
| | R22563003 | Minuterie specchi distanziale maschio/femmina - Male/female mirror spacers | 10,00 |
| 56314 | R22563001 | Minuterie specchi 1 gancio + 2 viti - Hardware 1 hook + 2 screws | 12,00 |
| | R22563003 | Minuterie specchi distanziale maschio/femmina - Male/female mirror spacers | 10,00 |
| 56315 | R22563001 | Minuterie specchi 1 gancio + 2 viti - Hardware 1 hook + 2 screws | 12,00 |
| | R22563003 | Minuterie specchi distanziale maschio/femmina - Male/female mirror spacers | 10,00 |



mobili & contenitori

Furniture and Cabinets _ Meubles et Armoires _ Schränke und Möbel

Mobili Componibili _ 304

Modular furniture _ Meubles à éléments modulaires _ Modulare Möbel

Piani top per lavabi _ 320

Tops for tabletop washbasins _ Plans pour vasques à poser _ Platte zum Aufsatzwaschbecken

Supporti per lavabo _ 322

Wash-basins supports _ Supports pour lavabo _ Halterungen zum Waschtisch

Colonne _ 328

Columns _ Colonne _ Hochschränke











Pensili _ 338

Wall units _ Meubles hauts _ Hängeschränke

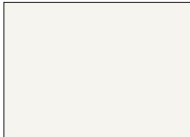
Basi su ruote _ 340

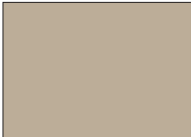
Drawer units on castors _ Meubles sur roulettes _ Schränke auf Rollen

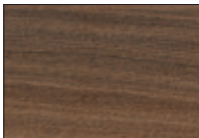
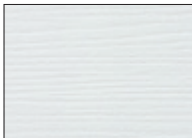
Finiture, Finishes-Finitions-Ausführung:

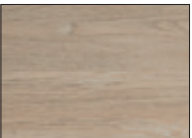
| | | | | |
|---|---|---|---|--|
| <p>Laccato lucido Glossy lacquered Laqué brillant Glänzend Lackiert</p>  <p>.09L</p> | <p>Laccato lucido Glossy lacquered Laqué brillant Glänzend Lackiert</p>  <p>.17L</p> | <p>Laccato lucido Glossy lacquered Laqué brillant Glänzend Lackiert</p>  <p>.21L</p> | <p>Laccato lucido Glossy lacquered Laqué brillant Glänzend Lackiert</p>  <p>.22L</p> | <p>Bambù Bamboo Bambou Bambus</p>  <p>.03</p> |
| <p>Laccato opaco Mat lacquered Laqué mat Matt Lackiert</p>  <p>.09</p> | <p>Laccato opaco Mat lacquered Laqué mat Matt Lackiert</p>  <p>.17</p> | <p>Laccato opaco Mat lacquered Laqué mat Matt Lackiert</p>  <p>.21</p> | <p>Laccato opaco Mat lacquered Laqué mat Matt Lackiert</p>  <p>.22</p> | |
| <p>Laminato Laminated Stratifié Holzlaminat</p>  <p>.03</p> | <p>Laminato Laminated Stratifié Holzlaminat</p>  <p>.01</p> | <p>Laminato Laminated Stratifié Holzlaminat</p>  <p>.02</p> | <p>Laminato Laminated Stratifié Holzlaminat</p>  <p>.05</p> | |



Grela

Mobili componibili / Modular furniture / Meubles à éléments modulaires / Modulare Möbel



GRELA

GRELA abaco

GRELA 1200 mm

Con lavabo incassato

built-in washbasins
lavabo encastré
Integriertes Waschbecken

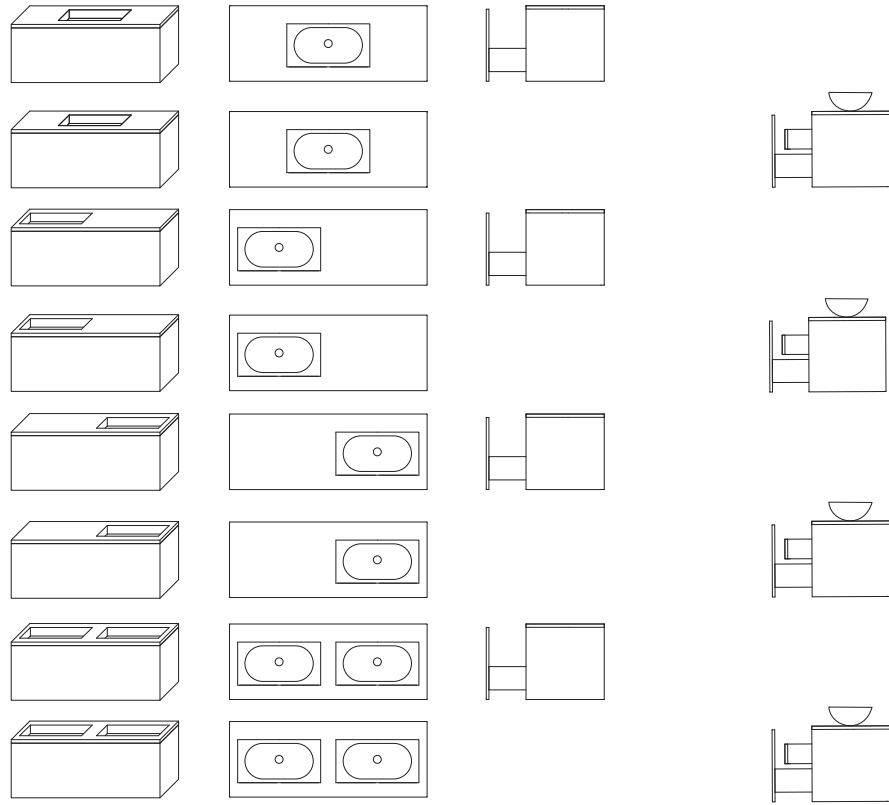

1 Cassettone
1 Drawer
1 Tiroir
1 Schublade

2 Cassetti
2 Drawers
2 Tiroirs
2 Schubladen

Con lavabo appoggio

countertop washbasins
vasque à poser
Aufsatzwaschbecken

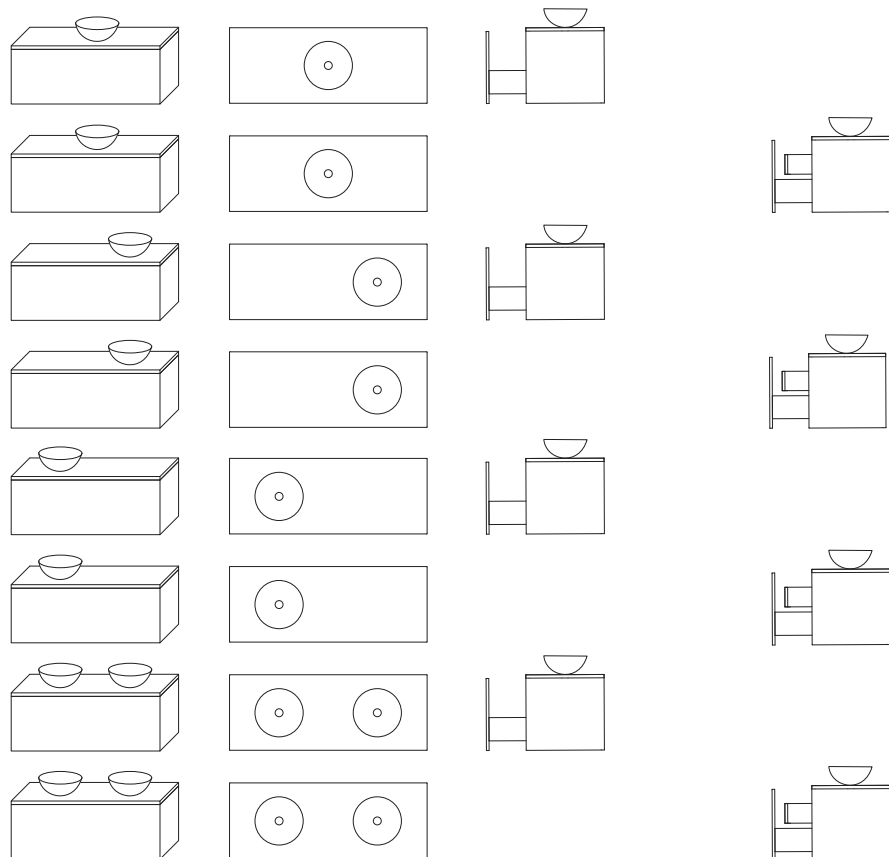

1 Cassettone
1 Drawer
1 Tiroir
1 Schublade

2 Cassetti
2 Drawers
2 Tiroirs
2 Schubladen

GRELA abaco

GRELA 900 mm

Con lavabo incassato

built-in washbasins
lavabo encastré
Integriertes Waschbecken

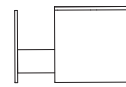
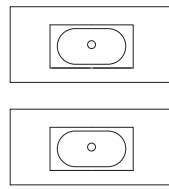
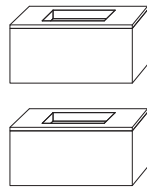

1 Cassettone
1 Drawer
1 Tiroir
1 Schublade

2 Cassetti
2 Drawers
2 Tiroirs
2 Schubladen

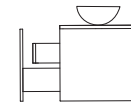

Con lavabo appoggio

countertop washbasins
vasque à poser
Aufsatzwaschbecken

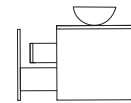
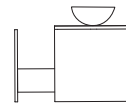
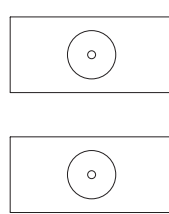
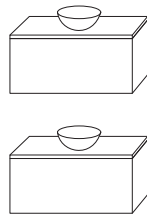

GRELA 600 mm

Con lavabo incassato

built-in washbasins
lavabo encastré
Integriertes Waschbecken

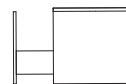
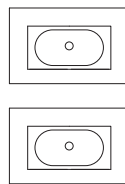
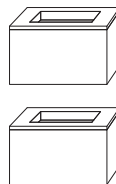

1 Cassettone
1 Drawer
1 Tiroir
1 Schublade

2 Cassetti
2 Drawers
2 Tiroirs
2 Schubladen

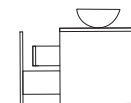

Con lavabo appoggio

countertop washbasins
vasque à poser
Aufsatzwaschbecken

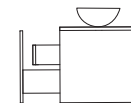
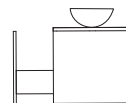
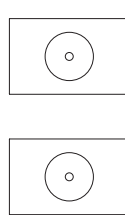
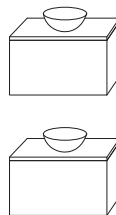

GRELA 430 mm

Con lavabo incassato

built-in washbasins
lavabo encastré
Integriertes Waschbecken

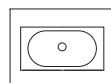
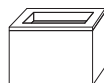

1 Cassettone
1 Drawer
1 Tiroir
1 Schublade

GRELA



Mobile componibile con lavabo ad incasso
 Modular furniture with built-in washbasin
 Meubles à éléments modulaires avec lavabo encastré
 Modulare Möbel mit integriertem Waschbecken

Mobile componibile con lavabo da appoggio
 Modular furniture with countertop washbasins
 Meubles à éléments modulaires avec vasque à poser
 Modulare Möbel mit Aufsatzbecken

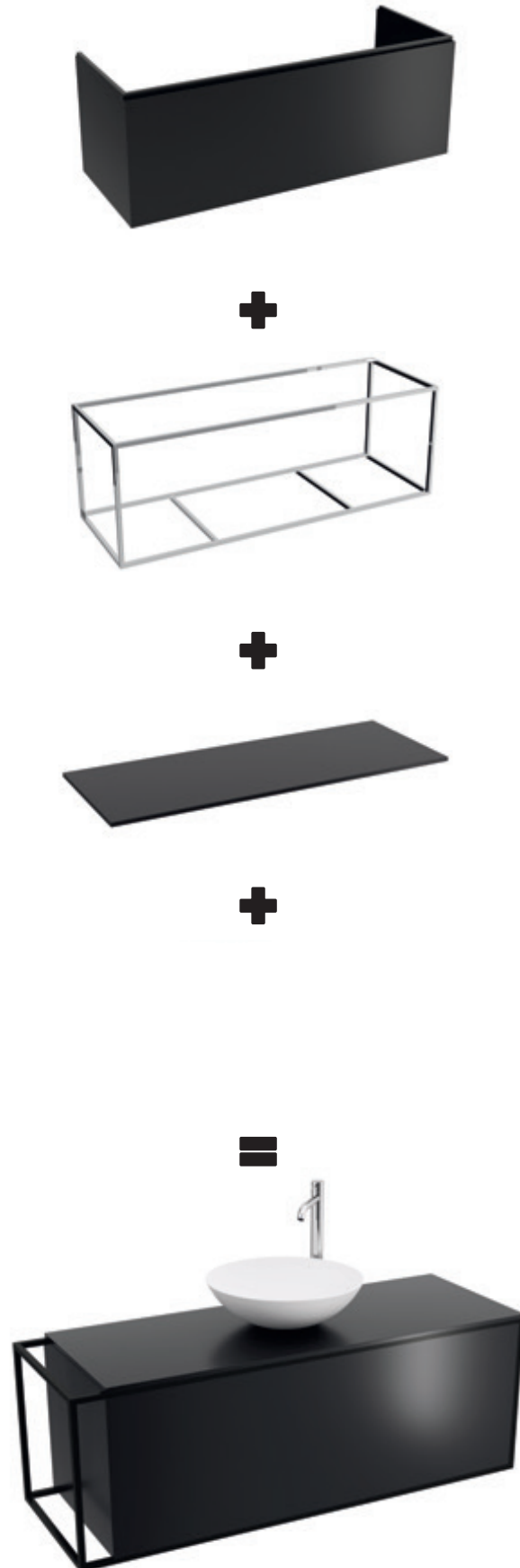
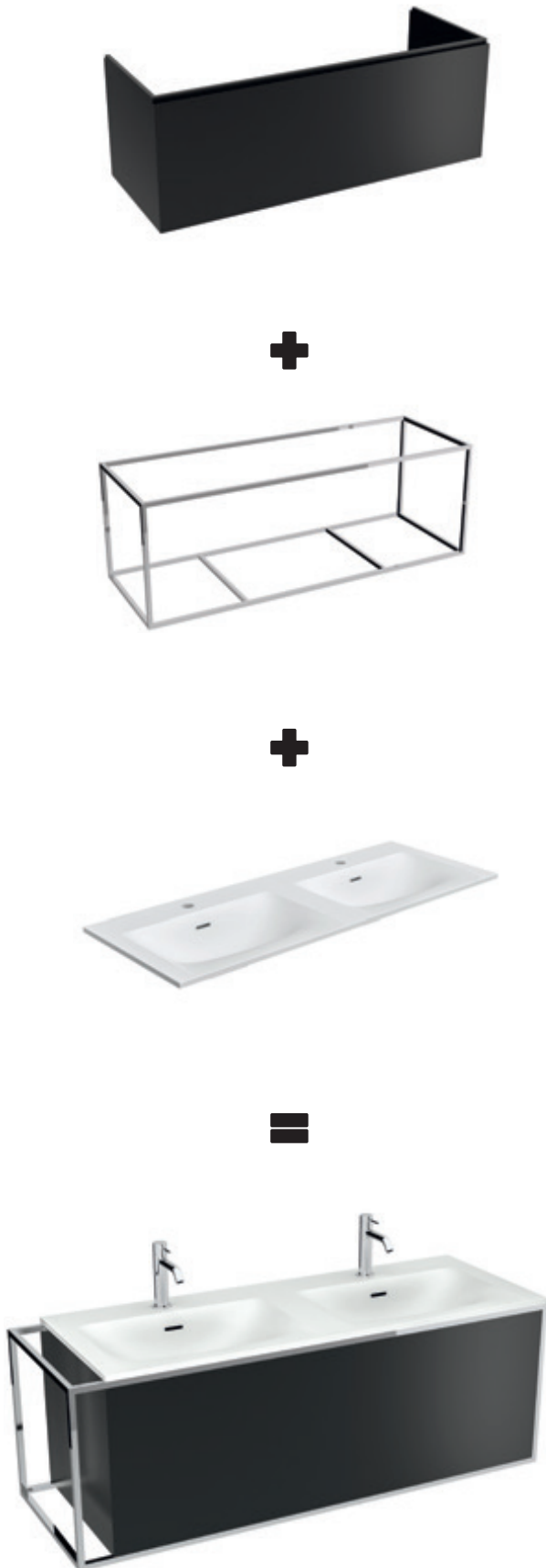







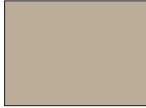

GRELA

| COD. | Descrizione / Description / Description / Beschreibung | L € | O € | N € |
|-------------------|--|--------|--------|--------|
| 8280.nn | Base sospesa 1200 mm con un cassettone push-pull Base unit 1 drawer push-pull Meuble bas avec 1 tiroir push-pull Unterschrank 1 Schublade push-pull | 773,00 | 708,00 | 561,00 |
| 8280DX.nn | Base sospesa 1200 mm con un cassettone push-pull per vasca a destra Base unit 1 drawer push-pull for right sink Meuble bas avec 1 tiroir push-pull pour évier droit Unterschrank 1 Schublade push-pull für rechte Waschbecken | 773,00 | 708,00 | 561,00 |
| 8280SX.nn | Base sospesa 1200 mm con un cassettone push-pull per vasca a sinistra Base unit 1 drawer push-pull for left sink Meuble bas avec 1 tiroir push-pull pour évier gauche Unterschrank 1 Schublade push-pull für linke Waschbecken | 773,00 | 708,00 | 561,00 |
| 82801.nn | Base sospesa 1200 mm con un cassettone push-pull + cassetto interno Base unit 1 drawer push-pull and internal drawer Meuble bas avec 1 tiroir push-pull et tiroir intérieur Unterschrank 1 Schublade push-pull und Innenschublade | 972,00 | 907,00 | 761,00 |
| 82801DX.nn | Base sospesa 1200 mm con un cassettone push-pull + cassetto interno per vasca a destra Base unit 1 drawer push-pull and internal drawer for right sink Meuble bas avec 1 tiroir push-pull et tiroir intérieur pour évier droit Unterschrank 1 Schublade push-pull und Innenschublade für rechte Waschbecken | 972,00 | 907,00 | 761,00 |
| 82801SX.nn | Base sospesa 1200 mm con un cassettone push-pull + cassetto interno per vasca a sinistra Base unit 1 drawer push-pull and internal drawer for left sink Meuble bas avec 1 tiroir push-pull et tiroir intérieur pour évier gauche Unterschrank 1 Schublade push-pull und Innenschublade für linke Waschbecken | 972,00 | 907,00 | 761,00 |
| 82802.nn | Base sospesa per doppio lavabo 1200 mm con un cassettone push-pull Base unit for 2 washbasins 1 drawer push-pull Meuble bas avec pour 2 lavabos 1 tiroir push-pull Unterschrank für 2 Waschbecken 1 Schublade push-pull | 773,00 | 708,00 | 561,00 |
| 82803.nn | Base sospesa per doppio lavabo 1200 mm con un cassettone push-pull + cassetto interno Base unit for 2 washbasins 1 drawer push-pull and internal drawer Meuble bas avec pour 2 lavabos 1 tiroir push-pull et tiroir intérieur Unterschrank 1 Schublade push-pull und Innenschublade | 972,00 | 907,00 | 761,00 |

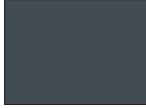
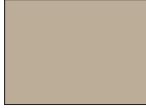

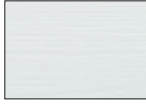
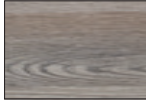
GRELA

| | | | | | | | |
|----------|--|---|--|---|---|---|---|
| L | Laccato lucido Glossy lacquered Laqué brillant Glänzend Lackiert |  |  |  |  | | |
| | | .09L | .17L | .21L | .22L | | |
| | | O | Laccato opaco Mat lacquered Laqué mat Matt Lackiert |  |  |  |  |
| | | | | .09 | .17 | .21 | .22 |
| N | Laminato Laminated Stratifié Holzlaminat |  |  |  |  | | |
| | | .03 | .01 | .02 | .05 | | |

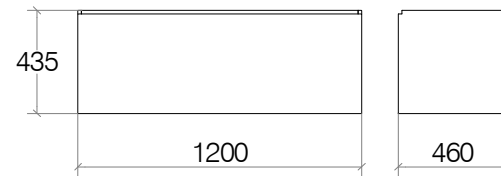

Telaio per base sospesa 1200 mm

Frame for suspended base unit 1200 mm / Structure pour meuble bas suspendu 1200 mm / Rahmen für Unterschrank 1200 mm

8281.nn

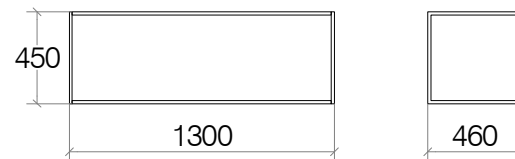
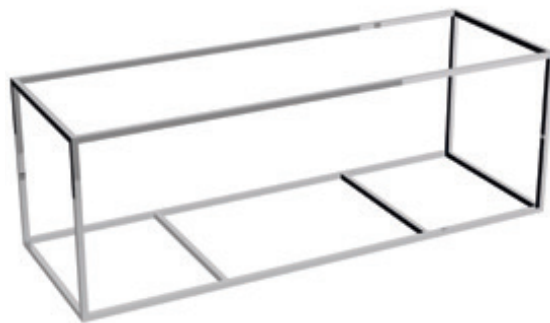

Acciaio verniciato
Painted steel
Acier laqué
Lackiertem Stahl



.09

651,00

Acciaio verniciato
Painted steel
Acier laqué
Lackiertem Stahl



.22

651,00

Acciaio inox lucido
Polished stainless steel
Acier inoxydable brillant
Poliert Edelstahl



.29

756,00

Acciaio inox spazzolato
Brushed stainless steel
Acier inoxydable brossé
Edelstahl Gebürstet



.32

756,00



GRELA

Lavabo a una vasca con foro rubinetto 1200 mm

Washbasin with hole for faucett 1200 mm / Lavabo avec perçage de robinetterie 1200 mm
Waschbecken mit Armaturloch 1200 mm

53573.26

549,00

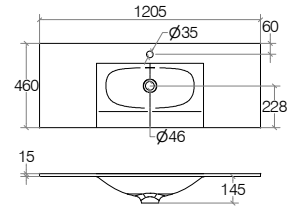

Mineralmarmo opaco
Matt mineral marble
Minéral marbre mat
Mineralguss matt

Lavabo a una vasca a destra con foro rubinetto 1200 mm

Washbasin with hole for faucett with right sink 1200 mm / Lavabo avec perçage de robinetterie avec vasque à droit 1200 mm. Waschbecken mit Armaturloch mit rechtem Waschbecken 1200 mm

53573DX.26

549,00

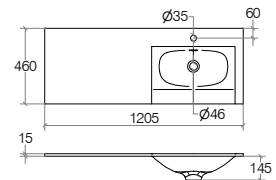

Mineralmarmo opaco
Matt mineral marble
Minéral marbre mat
Mineralguss matt

Lavabo a una vasca a sinistra con foro rubinetto 1200 mm

Washbasin with hole for faucett with left sink 1200 mm / Lavabo avec perçage de robinetterie avec vasque à gauche 1200 mm. Waschbecken mit Armaturloch mit linkem Waschbecken 1200 mm

53573SX.26

549,00

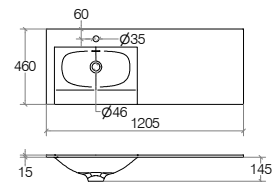

Mineralmarmo opaco
Matt mineral marble
Minéral marbre mat
Mineralguss matt

Lavabo a due vasche con foro rubinetto 1200 mm

Washbasin with hole for faucett with double sink 1200 mm / Lavabo avec perçage de robinetterie avec double vasque 1200 mm. Waschbecken mit Armaturloch mit doppelt Waschbecken 1200 mm

535732.26

615,00

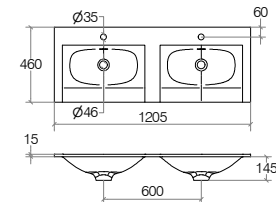

Mineralmarmo opaco
Matt mineral marble
Minéral marbre mat
Mineralguss matt

Lavabo a una vasca con foro rubinetto 1200 mm

Washbasin with hole for faucett 1200 mm / Lavabo avec perçage de robinetterie 1200 mm
Waschbecken mit Armaturloch 1200 mm

53576.09

603,00

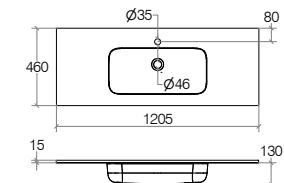

Mineralmarmo opaco
Matt mineral marble
Minéral marbre mat
Mineralguss matt

Lavabo a due vasche con foro rubinetto 1200 mm

Washbasin with hole for faucett with double sink 1200 mm / Lavabo avec perçage de robinetterie avec double vasque 1200 mm. Waschbecken mit Armaturloch mit doppelt Waschbecken 1200 mm

535762.09

676,00

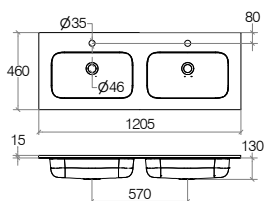

Mineralmarmo opaco
Matt mineral marble
Minéral marbre mat
Mineralguss matt

GRELA

| COD. | Descrizione / Description / Description / Beschreibung | L € | O € | N € |
|----------------|--|--------|--------|--------|
| 8282.nn | Top per base sospesa 1200 mm Top for drawer unit 1200 mm Plan pour meuble 1200 mm Platte für Schrank 1200 mm | 265,00 | 253,00 | 152,00 |

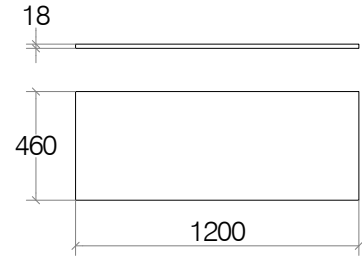

| | | | | | | | |
|----------|--|---|--|---|---|--|--|
| L | Laccato lucido Glossy lacquered Laqué brillant Glänzend Lackiert |  |  |  |  | | |
| | | .09L | .17L | .21L | .22L | | |
| | | O | Laccato opaco Mat lacquered Laqué mat Matt Lackiert |  |  |  |  |
| | | | | .09 | .17 | .21 | .22 |
| N | Laminato Laminated Stratifié Holzlaminat |  |  |  |  | | |
| | | .03 | .01 | .02 | .05 | | |

Per tutti i lavabi in appoggio vedi pag. 352-360

For all countertop washbasins see pages: 352-360 / Pour les vasques à poser voir pages : 352-360 / Für Aufsatzbecken siehe Seiten: 352-360.

1 Cassettone
1 Drawer / 1 Tiroir / 1 Schublade



2 Cassetti
2 Drawers / 2 Tiroirs / 2 Schubladen



GRELA

| COD. | Descrizione / Description / Description / Beschreibung | L € | O € | N € |
|-----------------|--|------------|------------|------------|
| 8260.nn | Base sospesa 900 mm con un cassettone push-pull Base unit 1 drawer push-pull Meuble bas avec 1 tiroir push-pull Unterschrank 1 Schublade push-pull | 702,00 | 642,00 | 524,00 |
| 82601.nn | Base sospesa 900 mm con un cassettone push-pull + cassetto interno Base unit 1 drawer push-pull and internal drawer Meuble bas avec 1 tiroir push-pull et tiroir intérieur Unterschrank 1 Schublade push-pull und Innenschublade | 894,00 | 834,00 | 715,00 |

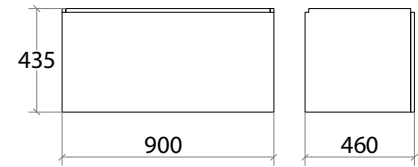

L

Laccato lucido
Glossy lacquered
Laqué brillant
Glänzend Lackiert



.09L



.17L



.21L

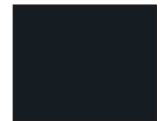

.22L

O

Laccato opaco
Mat lacquered
Laqué mat
Matt Lackiert



.09

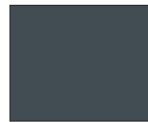

.17



.21

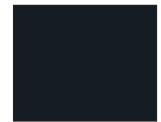

.22

N

Laminato
Laminated
Stratifié
Holzlaminat

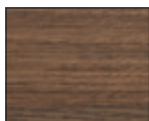

.03



.01

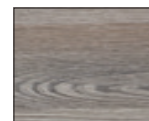

.02



.05

GRELA

Telaio per base sospesa 900 mm

Frame for suspended base / Structure pour meuble bas suspendu / Rahmen für Unterschrank

8261.nn

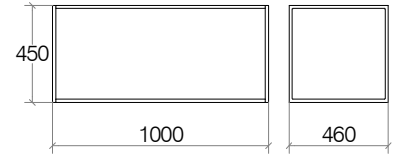

Acciaio verniciato
Painted steel
Acier laqué
Lackiertem Stahl



.09

563,00

Acciaio verniciato
Painted steel
Acier laqué
Lackiertem Stahl



.22

563,00

Acciaio inox lucido
Polished stainless steel
Acier inoxydable brillant
Poliert Edelstahl



.29

680,00

Acciaio inox spazzolato
Brushed stainless steel
Acier inoxydable brossé
Edelstahl Gebürstet



.32

680,00

Lavabo a una vasca con foro rubinetto 900 mm

Washbasin with hole for faucet 900 mm / Lavabo avec perçage de robinetterie 900 mm
Waschbecken mit Armaturloch 900 mm

53572.26

374,00

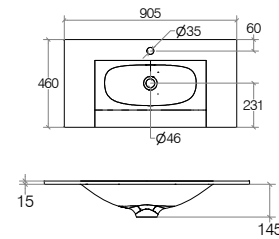

Mineralmarmo opaco
Matt mineral marble
Minéral marbre mat
Mineralguss matt

Lavabo a una vasca con foro rubinetto 900 mm

Washbasin with mixer hole 900 mm / Lavabo avec perçage de robinetterie 900 mm
Waschbecken mit Armaturloch 900 mm

53575.09

411,00

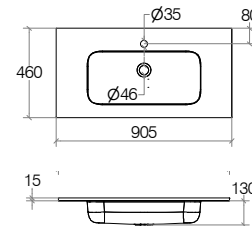

Mineralmarmo opaco
Matt mineral marble
Minéral marbre mat
Mineralguss matt

| COD. | Descrizione / Description / Description / Beschreibung | L € | O € | N € |
|----------------|--|--------|--------|--------|
| 8262.nn | Top per base sospesa 900 mm Top for drawer unit 900 mm Plan pour meuble 900 mm Platte für Schrank 900 mm | 232,00 | 223,00 | 142,00 |

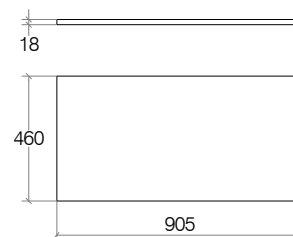

GRELA

| COD. | Misure / Measure / Mesure / Maß | L € | O € | N € |
|-----------------|--|------------|------------|------------|
| 8240.nn | Base sospesa 600 mm con un cassettone push-pull Base unit 1 drawer push-pull Meuble bas avec 1 tiroir push-pull Unterschrank 1 Schublade push-pull | 624,00 | 571,00 | 478,00 |
| 82401.nn | Base sospesa 600 mm con un cassettone push-pull + cassetto interno Base unit 1 drawer push-pull and internal drawer Meuble bas avec 1 tiroir push-pull et tiroir intérieur Unterschrank 1 Schublade push-pull und Innenschublade | 802,00 | 749,00 | 657,00 |

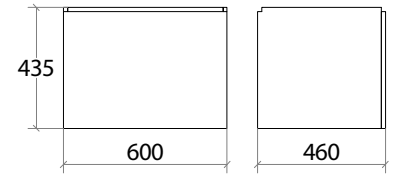

L

Laccato lucido
Glossy lacquered
Laqué brillant
Glänzend Lackiert



.09L



.17L



.21L



.22L

O

Laccato opaco
Mat lacquered
Laqué mat
Matt Lackiert



.09

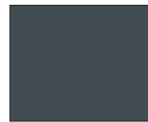

.17



.21

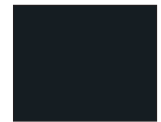

.22

N

Laminato
Laminated
Stratifié
Holzlaminat

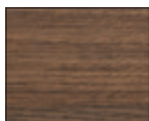

.03



.01



.02



.05

Telaio per base sospesa 600 mm

Frame for suspended base / Structure pour meuble bas suspendu / Rahmen für Unterschrank

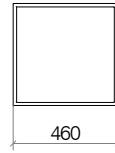
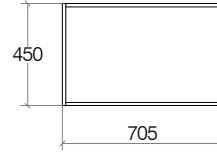

8241.nn



Acciaio verniciato
Painted steel
Acier laqué
Lackiertem Stahl



.09

471,00

Acciaio verniciato
Painted steel
Acier laqué
Lackiertem Stahl



.22

471,00

Acciaio inox lucido
Polished stainless steel
Acier inoxydable brillant
Poliert Edelstahl



.29

601,00

Acciaio inox spazzolato
Brushed stainless steel
Acier inoxydable brossé
Edelstahl Gebürstet



.32

601,00

Lavabo a una vasca con foro rubinetto 600 mm

Washbasin with mixer hole 600 mm / Lavabo avec perçage de robinetterie 600 mm
Waschbecken mit Armaturloch 600 mm

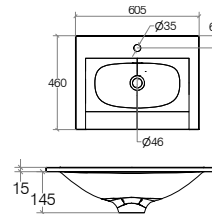

53571.26

281,00

Mineralmarmo opaco
Matt mineral marble
Minéral marbre mat
Mineralguss matt

Lavabo a una vasca con foro rubinetto 600 mm

Washbasin with mixer hole 600 mm / Lavabo avec perçage de robinetterie 600 mm
Waschbecken mit Armaturloch 600 mm

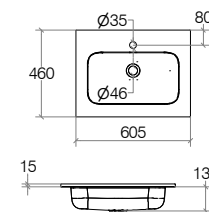

53574.09

304,00

Mineralmarmo opaco
Matt mineral marble
Minéral marbre mat
Mineralguss matt

| COD. | Descrizione / Description / Description / Beschreibung | L € | O € | N € |
|----------------|--|--------|--------|--------|
| 8242.nn | Top per base sospesa 600 mm Top for drawer unit 600 mm Plan pour meuble 600 mm Platte für Schrank 600 mm | 200,00 | 192,00 | 131,00 |

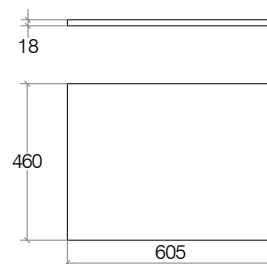

GRELA

Base sospesa 430 mm con anta push-pull

Base unit 430mm with a push pull door
 Meuble bas 430 mm avec porte push-pull
 Unterschrank 430 mm mit einer Push-Pull-Tür

8220.nn

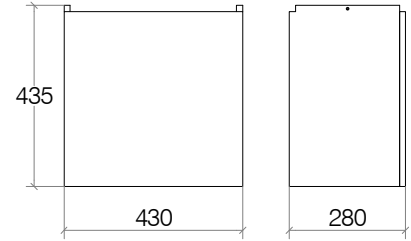

L **Laccato lucido**
 Glossy lacquered
 Laqué brillant
 Glänzend Lackiert



.09L



.17L



.21L



.22L

376,00

O **Laccato opaco**
 Mat lacquered
 Laqué mat
 Matt Lackiert



.09

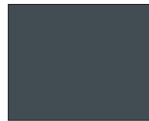

.17



.21

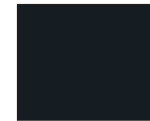

.22

336,00

N **Laminato**
 Laminated
 Stratifié
 Holzlaminat



.03



.01



.02

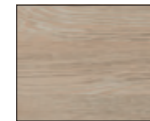

.05

280,00

Lavabo con foro rubinetto in mineralmarmo opaco

Washbasin with hole for faucet / Lavabo avec perçage de robinetterie / Waschbecken mit Armaturloch

53570.26

223,00

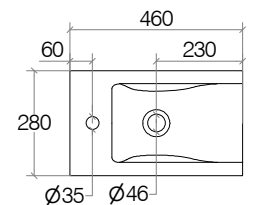

Mineralmarmo opaco
 Matt mineral marble
 Minéral marbre mat
 Mineralguss matt



GRELA

Telaio per base sospesa 430 mm

Frame for suspended base unit / Structure pour meuble bas suspendu / Rahmen für Unterschrank

8221.nn

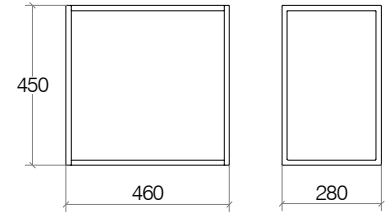

Acciaio verniciato

Painted steel
Acier laqué
Lackiertem Stahl



.09

418,00

Acciaio verniciato

Painted steel
Acier laqué
Lackiertem Stahl



.22

418,00

Acciaio inox lucido

Polished stainless steel
Acier inoxydable brillant
Poliert Edelstahl



.29

483,00

Acciaio inox spazzolato

Brushed stainless steel
Acier inoxydable brossé
Edelstahl Gebürstet

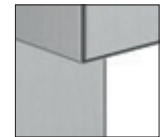

.32

483,00

Tasca in tessuto con clip per attacco a telaio 'GRELA'

Pouch with clip for 'GRELA' frame / Pochette avec clip pour structure 'GRELA' / Tasche mit Klipp für Halterung 'GRELA'

7218.nn

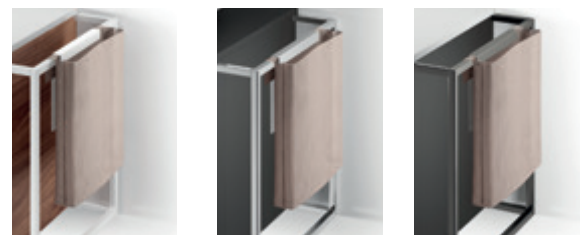
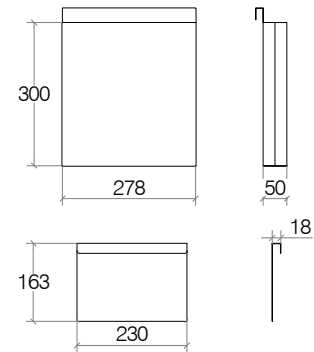

.09

38,00

.29

38,00

.32

38,00



DE SORA

Piano Top, spessore 57 mm, profondità 435 mm, con staffe a vista in acciaio.

Top shelf with visible steel brackets / Plan avec supports visibles en acier / Oberstes Regal mit sichtbaren Stahlbügeln

| COD. | Misure / Measure / Dimensions / Maß | L € | O € | N € |
|----------|-------------------------------------|--------|--------|--------|
| 82941.nn | 800 ÷ 1190 mm | 495,00 | 480,00 | 415,00 |
| 82942.nn | 1200 ÷ 1590 mm | 572,00 | 556,00 | 473,00 |
| 82943.nn | 1600 ÷ 2400 mm | 683,00 | 662,00 | 546,00 |

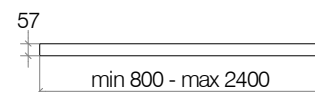

Per tutti i lavabi in appoggio vedi pag. 352

For all countertop washbasin see pages: 352
 Pour tous les vasques à poser voir pages : 352
 Für Aufsatzbecken siehe Seiten: 352

L **Laccato lucido**
 Glossy lacquered
 Laqué brillant
 Glänzend Lackiert

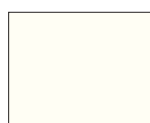

.09L



.17L



.21L



.22L

O **Laccato opaco**
 Mat lacquered
 Laqué mat
 Matt Lackiert



.09



.17



.21



.22

N **Laminato**
 Laminated
 Stratifié
 Holzlaminat

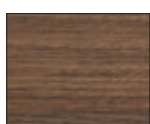

.03



.01

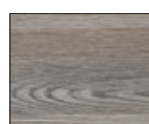

.02

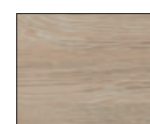

.05

DE SORA

Piano Gobba, spessore 38 mm, profondità 435 mm, con staffe a vista in acciaio.

Top shelf with visible steel brackets / Plan avec supports visibles en acier / Oberstes Regal mit sichtbaren Stahlbügeln

| COD. | Misure / Measure / Dimensions / Maß | L € | O € | N € |
|------------|-------------------------------------|---------|---------|--------|
| 82951DX.nn | 800 ÷ 1190 mm | 881,00 | 811,00 | 654,00 |
| 82951SX.nn | 800 ÷ 1190 mm | 881,00 | 811,00 | 654,00 |
| 82952DX.nn | 1200 ÷ 1590 mm | 992,00 | 921,00 | 742,00 |
| 82952SX.nn | 1200 ÷ 1590 mm | 992,00 | 921,00 | 742,00 |
| 82953DX.nn | 1600 ÷ 2400 mm | 1175,00 | 1097,00 | 882,00 |
| 82953SX.nn | 1600 ÷ 2400 mm | 1175,00 | 1097,00 | 882,00 |

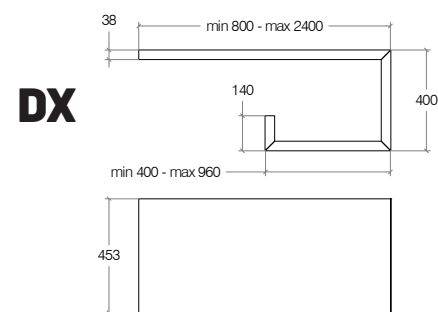
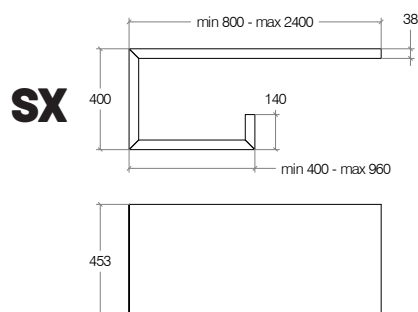
**la misura della mensola inferiore è sempre pari al 40% della mensola superiore (non oltre le dimensioni indicate)**

The size of the lower shelf is always equal to 40% of the upper shelf (no more than the dimensions indicated)

La dimensions de l'étagère inférieure est toujours égale à 40% de l'étagère supérieure (pas plus que les dimensions indiquées)

Die Größe des unteren Regals entspricht immer 40% des oberen Regals (nicht mehr als die angegebenen Dimensionen)

CANAVERA

Supporto per lavabo 700 mm

Wash-table unit 700 mm / Meuble pour lavabo 700 mm / Waschtisch 700 mm

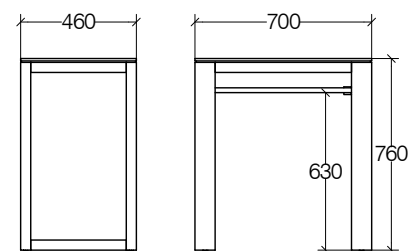

Bambù verniciato

Vernished Bamboo
Bambou verni
Zinnobambus



81107

.03

€

704,00



Supporto per lavabo 1000 mm

Wash-table unit 1000 mm / Meuble pour lavabo 1000 mm / Waschtisch 1000 mm

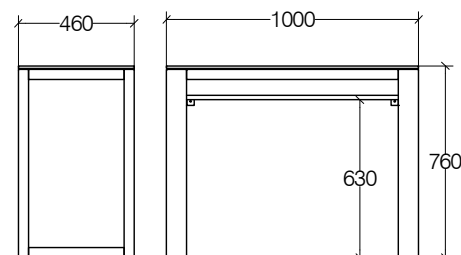

Bambù verniciato

Vernished Bamboo
Bambou verni
Zinnobambus



81110

.03

€

778,00



CANAVERA

Supporto per lavabo 1300 mm

Wash-table unit 1300 mm / Meuble pour lavabo 1300 mm / Waschtisch 1300 mm

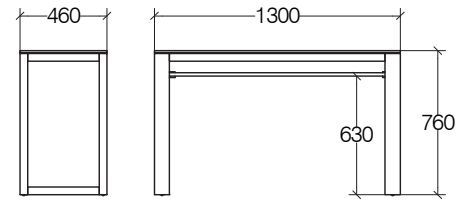

Bambù verniciato
Vernished Bamboo
Bambou verni
Zinnobambus



| | |
|--------------|------------|
| 81113 | .03 |
| € | 889,00 |



Panca

Bench / Banc / Bank

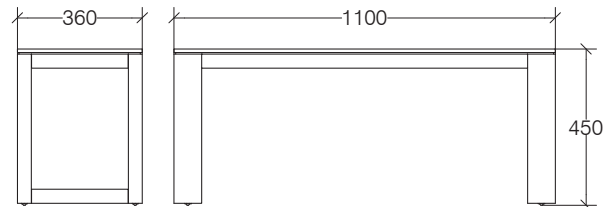

Bambù verniciato
Vernished Bamboo
Bambou verni
Zinnobambus



| | |
|--------------|------------|
| 81120 | .03 |
| € | 524,00 |



CANAVERA

Sgabello

Stool / Tabouret / Hocker

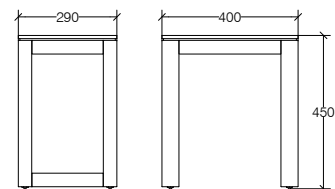

Bambù verniciato

Vernished Bamboo
Bambou verni
Zinnobambus



81119

.03

€

301,00



Specchio contenitore reversibile con ripiani in vetro

Reversible container mirror with glass shelves / Armoire de toilette reversible avec miroir
Spiegelbehälter mit Glasablage Wechselseitige Montage

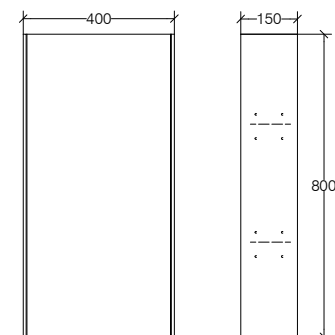

Bambù verniciato

Vernished Bamboo
Bambou verni
Zinnobambus



81141

.03

€

471,00



CANAVERA

Specchio con cornice verticale o orizzontale

Mirror vertical or horizontal with frame / Miroir vertical ou horizontal, avec cadre
Spiegel mit Rahmen, senkrecht oder waagrecht

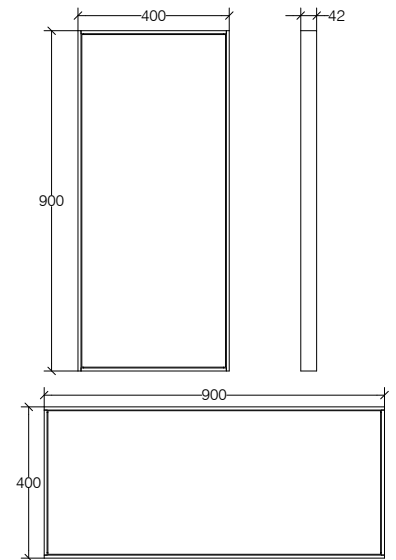

Bambù verniciato
Vernished Bamboo
Bambou verni
Zinnobambus



81140

.03

€

268,00



GOTO

Supporto vasca con foro rubinetto e tappo

Wall support, with tap hole / Support avec perçage de robinetterie
 Wandhalterung für Becken mit Hahnloch

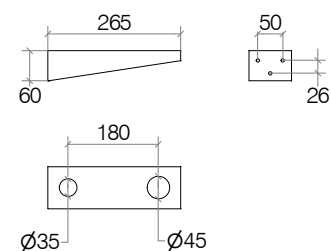
**Combinabile con Serie Busi e Cane**

Matching with Busi e Cane collection
 À équiper avec collection Busi e Cane
 Verwendbar mit Kollektion Busi e Cane



Acciaio inox
 Stainless steel
 Acier inoxydable
 Rostfreier stahl



66213

.29

€

99,00



GOTO



colonne

Columns _ Colones _ Hochschränken

Ciacole:

le chiacchiere tra comari, quelle che s'impicciano più degli affari altrui che dei propri.

La collezione è composta da una serie di mobiletti in alluminio verniciato a giorno o con anta a specchio.

EN

CIACOLE:

chatter between women, those who mind other people's business more than their own.

The collection consists of a range of cabinets in painted aluminium, unframed or with a mirror door.

FR

CIACOLE :

bavardages entre commères, celles qui s'intéressent aux affaires des autres.

La collection se compose d'une série de meubles en aluminium verni, ouverts ou avec panneau miroir.













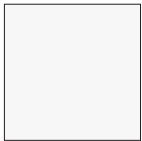

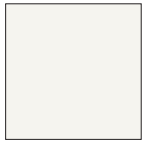

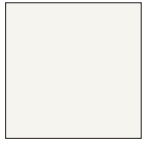

DE

CIACOLE:

ein Schwätzchen unter Klatschtanten, jene also, die sich mehr in die Angelegenheiten anderer einmischen, als in die eigenen.

Die Kollektion besteht aus einer Reihe von kleinen Möbelstücken aus lackiertem Aluminium, die entweder vorne offen sind oder eine Spiegeltür haben.

Finiture _ Finishes _ Finitions _ Ausführung:

| | | | | | |
|---|--|---|---|--|---|
| <p>Acciaio inox lucido Polished stainless steel Acier inox brillant Glänzer Edelstahl</p>  <p>.29</p> | <p>Inox spazzolato Brushed stainless Inoxydable brossé Edelstahl Gebürstet</p>  <p>.32</p> | <p>Specchio Mirror Miroir Spiegel</p>  <p>.09</p> | <p>Alluminio verniciato bianco White painted aluminium Aluminium laqué blanc Lackiertes Weiß Aluminium</p>  <p>.09</p> | <p>Alluminio verniciato nero Black painted aluminium Aluminium laqué noir Lackiertes Schwarz Aluminium</p>  <p>.23</p> | |
| <p>Laccato lucido Glossy lacquered Laqué brillant Glänzend Lackiert</p>  <p>.09L</p> | <p>Laccato lucido Glossy lacquered Laqué brillant Glänzend Lackiert</p>  <p>.17L</p> | <p>Laccato lucido Glossy lacquered Laqué brillant Glänzend Lackiert</p>  <p>.21L</p> | <p>Laccato lucido Glossy lacquered Laqué brillant Glänzend Lackiert</p>  <p>.22L</p> | | |
| <p>Laccato opaco Mat lacquered Laqué mat Matt Lackiert</p>  <p>.09</p> | <p>Laccato opaco Mat lacquered Laqué mat Matt Lackiert</p>  <p>.17</p> | <p>Laccato opaco Mat lacquered Laqué mat Matt Lackiert</p>  <p>.21</p> | <p>Laccato opaco Mat lacquered Laqué mat Matt Lackiert</p>  <p>.22</p> | <p>Verniciato sage Sage painted Laqué sage Lackiertes Sage</p>  <p>.73</p> | <p>Verniciato ambra Ambra painted Laqué ambra Lackiertes Ambra</p>  <p>.86</p> |
| <p>Laminato Laminated Stratifié Holzlaminat</p>  <p>.03</p> | <p>Laminato Laminated Stratifié Holzlaminat</p>  <p>.01</p> | <p>Laminato Laminated Stratifié Holzlaminat</p>  <p>.02</p> | <p>Laminato Laminated Stratifié Holzlaminat</p>  <p>.05</p> | | |

CIACOLE

Colonna girevole con specchio

Swivel cabinet with mirror / Colonne pivotante avec miroir / Drehbarer Schrank mit Spiegel

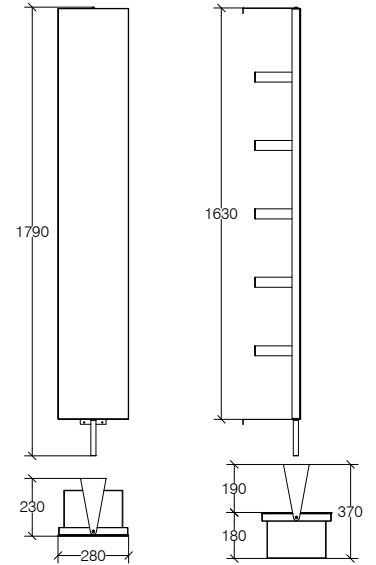

Verniciato bianco
White painted
Laqué blanc
Lackiertem Weiß

Verniciato nero
Black painted
Laqué noir
Lackiertem Schwarz

new
Verniciato sage
Sage painted
Laqué sage
Lackiertes Sage

new
Verniciato ambra
Ambra painted
Laqué ambra
Lackiertes Ambra



| | | | | |
|-------------|------------|------------|------------|------------|
| 8040 | .09 | .23 | .73 | .86 |
| € | 569,00 | 569,00 | 569,00 | 569,00 |



CIACOLE

Colonna girevole con specchio

Swivel cabinet with mirror / Colonne pivotante avec miroir / Drehbarer Schrank mit Spiegel

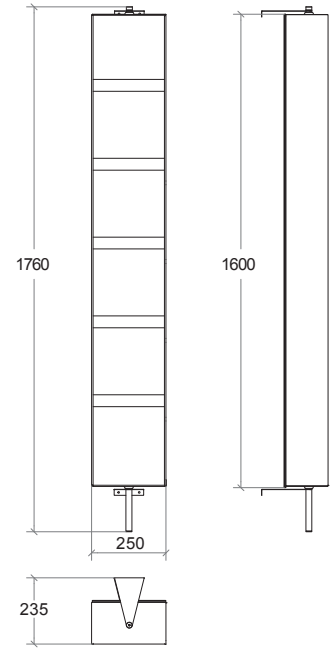

CIACOLE

Verniciato bianco
White painted
Laqué blanc
Lackiertem Weiß

Verniciato nero
Black painted
Laqué noir
Lackiertem Schwarz

new
Verniciato sage
Sage painted
Laqué sage
Lackiertes Sage

new
Verniciato ambra
Amбра painted
Laqué amбра
Lackiertes Amбра



| | | | | |
|-------------|------------|------------|------------|------------|
| 8059 | .09 | .23 | .73 | .86 |
| € | 677,00 | 677,00 | 677,00 | 677,00 |

CIACOLE

Colonna con anta a specchio

Cabinet with mirror door / Colonne avec porte miroir / Schrank mit Spiegeltür

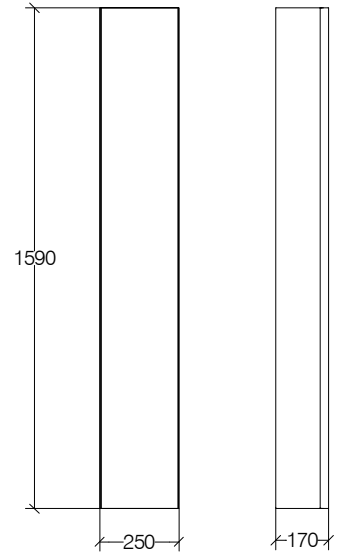

Verniciato bianco
White painted
Laqué blanc
Lackiertem Weiß

Verniciato nero
Black painted
Laqué noir
Lackiertem Schwarz

new
Verniciato sage
Sage painted
Laqué sage
Lackiertes Sage

new
Verniciato ambra
Amбра painted
Laqué amбра
Lackiertes Amбра



| | | | | |
|-------------|------------|------------|------------|------------|
| 8052 | .09 | .23 | .73 | .86 |
| € | 695,00 | 695,00 | 695,00 | 695,00 |



Colonna con anta a specchio e ripiani in vetro

Cabinet with mirror door and glass shelves / Colonne avec porte miroir et étagère en verre / Schrank mit Spiegeltür und Glasablage

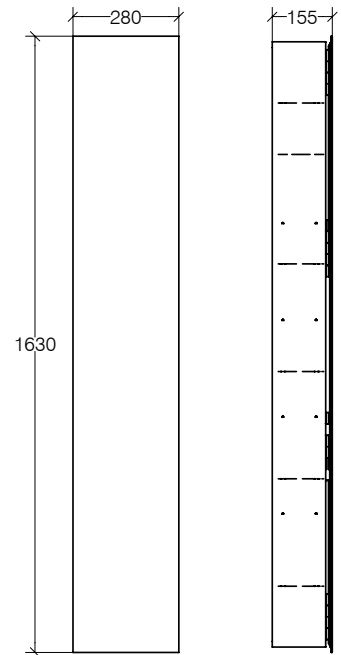

CIACOLE

Acciaio inox lucido
Polished stainless steel
Acier inox brillant
Glänzer Edelstahl



51504

.29.79

€

602,00

PIKÀ

Colonna girevole con specchio e ripiani in vetro

Swivel cabinet with mirror and glass shelves / Colonne pivotante avec miroir et étagère en verre / Drehbarer Schrank mit Spiegel und Glasablage

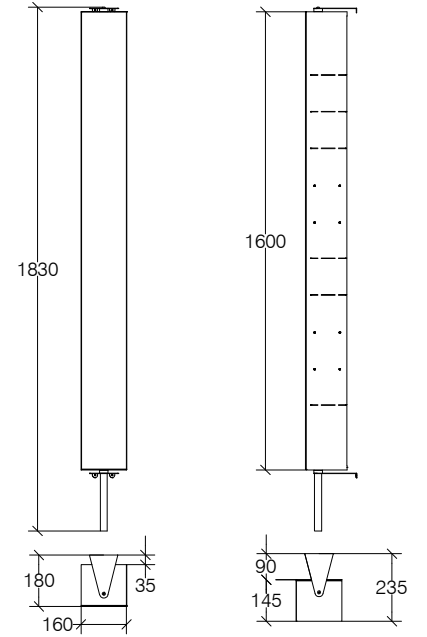

Acciaio inox lucido
Polished stainless steel
Acier inox brillant
Glänzer Edelstahl



| | |
|--------------|------------|
| 51505 | .29 |
| € | 422,00 |



Colonna girevole con specchio e ripiani in vetro

Swivel cabinet with mirror and glass shelves / Colonne pivotante avec miroir et étagère en verre / Drehbarer Schrank mit Spiegel und Glasablage

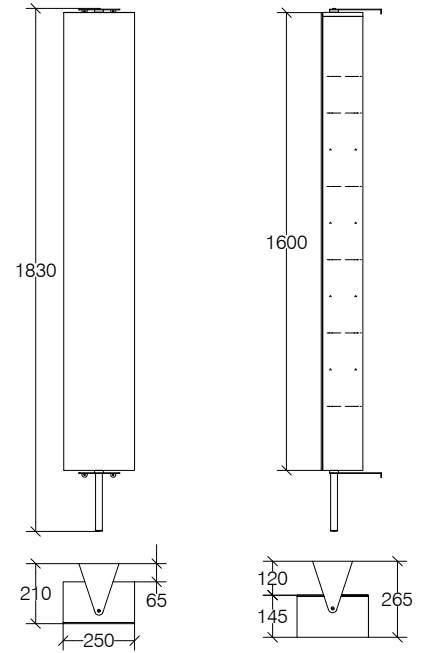

PIKÀ

Acciaio inox lucido
Polished stainless steel
Acier inox brillant
Glänzer Edelstahl



51506

.29

€

450,00



PIKÀ

Colonna girevole con specchio e ripiani in vetro

Swivel cabinet with mirror and glass shelves / Colonne pivotante avec miroir et étagère en verre / Drehbarer Schrank mit Spiegel und Glasablage

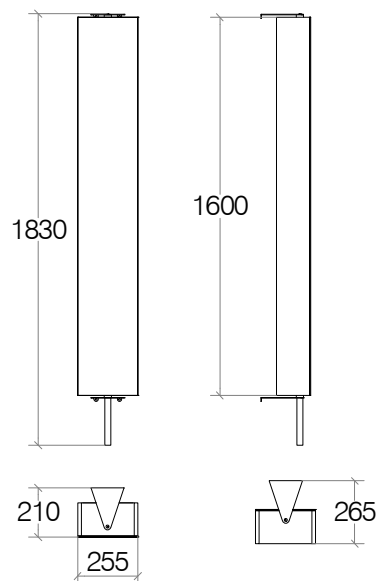

La staffa è sempre in ottone cromato

The bracket is always in chromed brass
Le support est toujours en laiton chromé
Die Halterung ist immer aus verchromtem Messing



Laccato lucido
Glossy lacquered
Laqué brillant
Glänzend Lackiert

Laccato opaco
Mat lacquered
Laqué mat
Matt Lackiert

Laminato
Laminated
Stratifié
Holzlaminat

| COD. | Descrizione _ Description _ Description _ Beschrieb | L € | O € | N € |
|-------------------------|--|--------|--------|--------|
| 8293 <small>ann</small> | Colonna girevole con specchio e ripiani in vetro Swivel cabinet with mirror and glass shelves Colonne pivotante avec miroir et étagère en verre Drehbarer Schrank mit Spiegel und Glasablage | 571,00 | 542,00 | 504,00 |

Colonna con anta destra o sinistra con apertura push-pull e ripiani in vetro

Cabinet with right/left door with push-pull and glass shelves / Colonne avec porte droite/ gauche push-pull et étagère en verre / Schrank mit rechte/ linke Tür push-pull und Glasablage

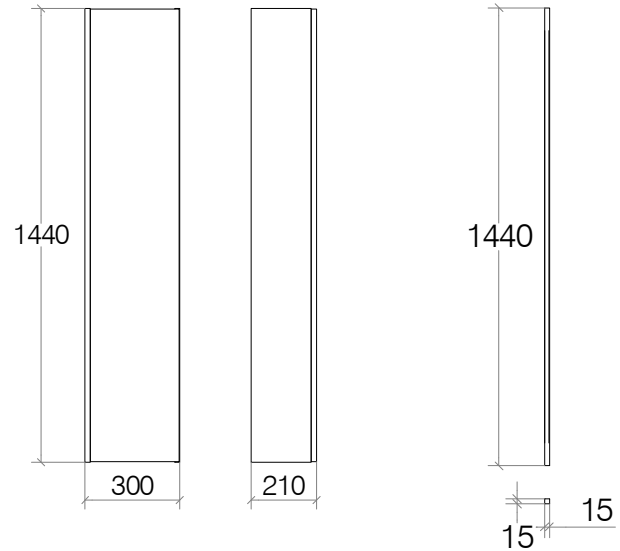
**Colonna da completare con profilo 82901 obbligatorio**

Cabinet must be completed with 82901 profile

Colonne à compléter avec la baguette 82901

Schrank muss mit dem Profil 82901 vervollständigt werden.



Laccato lucido
Glossy lacquered
Laqué brillant
Glänzend Lackiert

Laccato opaco
Mat lacquered
Laqué mat
Matt Lackiert

Laminato
Laminated
Stratifié
Holzlaminiert

| COD. | Descrizione _ Description _ Description _ Beschrieb | L € | O € | N € |
|----------------------------------|---|--------|--------|-------------|
| 8290DX <small>.an</small> | Colonna con anta destra Cabinet with right door / Colonne avec porte droite / Schrank mit rechte Tür | 590,00 | 528,00 | 401,00 |
| 8290SX <small>.an</small> | Colonna con anta sinistra Cabinet with left door / Colonne avec porte gauche / Schrank mit linke Tür | 590,00 | 528,00 | 401,00 |
| COD. | Descrizione _ Description _ Description _ Beschrieb | .09 € | .22 € | .29 - .32 € |
| 82901 <small>.an</small> | Profilo per colonna H. 1440 mm Cabinet profile 1440 mm / Baguette pour colonne 1440 mm / Drehbarer profil 1440 mm | 75,00 | 75,00 | 108,00 |

GRELA_CIACOLE

Pensile con anta destra con apertura push-pull e ripiani in vetro

Cabinet with right/left door push-pull and glass shelves / Armoire avec porte droite/ gauche push-pull et étagère en verre / Schrank mit rechte/ linke Tür push-pull und Glasablage

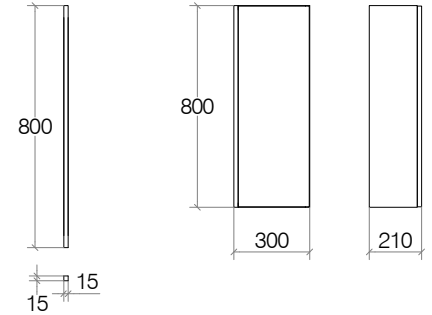

Pensile da completare con profilo 82911 obbligatorio

Cabinet must be completed with 82911 profile
Armoire à compléter avec la baguette 82911
Schrank muss mit dem Profil 82911 vervollständigt werden.

| COD. | Descrizione _ Description _ Description _ Beschrieb | L € | O € | N € |
|-------------|--|--------------|--------------|--------------------|
| 8291DX.nn | Pensile con anta destra Cabinet with right door / Armoire avec porte droite / Schrank mit rechte Tür | 464,00 | 404,00 | 330,00 |
| 8291SX.nn | Pensile con anta sinistra Cabinet with left door / Armoire avec porte gauche / Schrank mit linke Tür | 464,00 | 404,00 | 330,00 |
| COD. | Descrizione _ Description _ Description _ Beschrieb | .09 € | .22 € | .29 - .32 € |
| 82911.nn | Profilo per pensile H. 800 mm Cabinet profile 800 mm / Baguette pour armoire 800 mm / Schrank profil | 58,00 | 58,00 | 87,00 |

Pensile con anta a specchio

Cabinet with mirror door / Armoire avec porte miroir / Schrank mit Spiegeltür

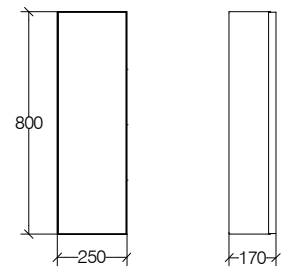

Verniciato bianco
White painted
Laqué blanc
Lackiertem Weiß

Verniciato nero
Black painted
Laqué noir
Lackiertem Schwarz

Verniciato sage
Sage painted
Laqué sage
Lackiertes Sage

Verniciato ambra
Ambr painted
Laqué ambr
Lackiertes Ambr



| 8051 | .09 | .23 | .73 | .86 |
|------|--------|--------|--------|--------|
| € | 542,00 | 542,00 | 542,00 | 542,00 |



Pensile con anta a specchio e ripiani in vetro

Cabinet with mirror door and glass shelves / Armoire avec porte miroir et étagère en verre / Schrank mit Spiegeltür und Glasablage

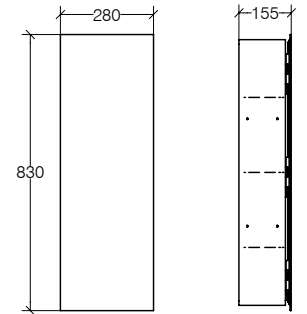

Acciaio inox lucido
Polished stainless steel
Acier inox brillant
Glänzer Edelstahl



| | |
|--------------|---------------|
| 51502 | .29.79 |
| € | 502,00 |



Pensile con anta a specchio e ripiani in vetro

Cabinet with mirror door and glass shelves / Armoire avec porte miroir et étagère en verre / Schrank mit Spiegeltür und Glasablage

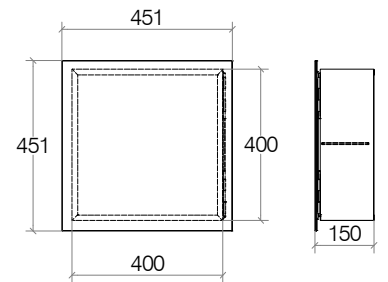

Acciaio inox lucido
Polished stainless steel
Acier inox brillant
Glänzer Edelstahl



| | |
|--------------|------------|
| 51511 | .29 |
| € | 369,00 |





basi su ruote

Drawer units on castors _ Meubles sur roulettes_ Schränke auf Rollen

Finiture _ Finishes _ Finitions _ Ausführung:

Acciaio verniciato

Painted steel
Acier laqué
Lackiertes edelstahl

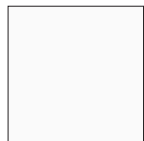

.09

Acciaio verniciato

Painted steel
Acier laqué
Lackiertes edelstahl



.23

Acciaio inox lucido

Polished stainless steel
Acier inox brillant
Glänzender edelstahl



.29.29

Mattstone

Mattstone
Mattstone
Mattstone

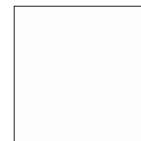

.26

Acciaio verniciato bianco

White painted steel
Acier laqué blanc
Lackiertes Weiß edelstahl



.09

Laminato

Laminated
Stratifié
Holzlaminat



.03

Laminato

Laminated
Stratifié
Holzlaminat



.05

RUNNER

RUNNER

Base 5 cassetti, con ruote

5 drawers unit on wheels / Meuble sur roulettes avec 5 tiroirs / Rollcontainer 5 Schubladen

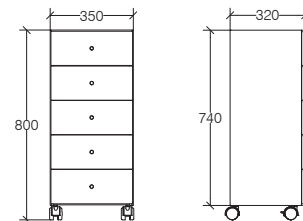

Acciaio inox lucido
Polished stainless steel
Acier inox brillant
Glänzender Edelstahl



5430

€

Acciaio verniciato
Painted stainless steel
Acier inox laqué
Lackiertem Edelstahl



.29.29

582,00

Laminato
Laminated
Stratifié
Holzlaminat



.09.05

582,00

Acciaio verniciato
Painted stainless steel
Acier inox laqué
Lackiertem Edelstahl



.23

582,00

Laminato
Laminated
Stratifié
Holzlaminat



.23.05

582,00

Copribase in mattstone

Mattstone top / Tablette en mattstone / Mattstoneplatte

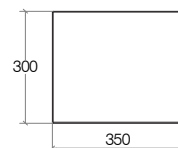
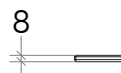
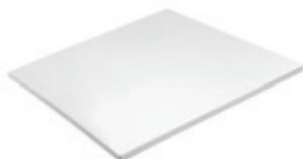

Mattstone
Mattstone
Mattstone
Mattstone



5442

€

.26

86,00

Base 2 cassetti, 1 anta, con ruote

1 door, 2 drawers unit on wheels / Meuble sur roulettes avec 2 tiroirs et 1 porte / Rollcontainer 2 Schublade 1 Tür

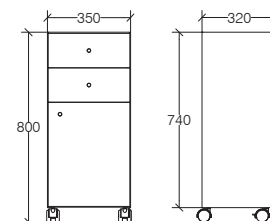

Acciaio inox lucido
Polished stainless steel
Acier inox brillant
Glänzender Edelstahl



5431

€

Acciaio verniciato
Painted stainless steel
Acier inox laqué
Lackiertem Edelstahl



.29.29

494,00

Laminato
Laminated
Stratifié
Holzlaminat



.09.05

494,00

Acciaio verniciato
Painted stainless steel
Acier inox laqué
Lackiertem Edelstahl



.23

494,00

Laminato
Laminated
Stratifié
Holzlaminat



.23.05

494,00

Copribase in mattstone

Mattstone top / Tablette en mattstone / Mattstoneplatte

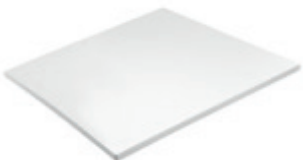

Mattstone
Mattstone
Mattstone
Mattstone



5442

€

.26

86,00

RUNNER

Base 1 cassetto, 1 anta, con ruote

1 door with 1 drawer on wheels / Meuble sur roulettes avec 1 tiroir et 1 porte / Rollcontainer 1 Schublade und 1 Tür

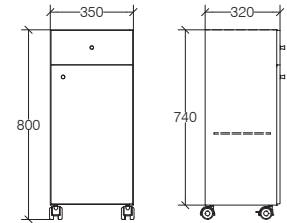

Acciaio inox lucido
Polished stainless steel
Acier inox brillant
Glänzer Edelstahl



| | |
|-------------|---------------|
| 5435 | .29.29 |
| € | 442,00 |

Copribase in mattstone

Mattstone top / Tablette en mattstone / Mattstoneplatte

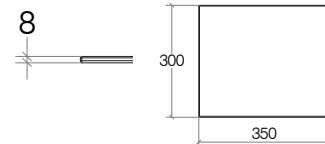

Mattstone
Mattstone
Mattstone
Mattstone



| | |
|-------------|------------|
| 5442 | .26 |
| € | 86,00 |

Base 3 cassetti, con ruote

3 drawers unit, on wheels / Meuble sur roulettes avec 3 tiroirs / Rollcontainer 3 Schubladen

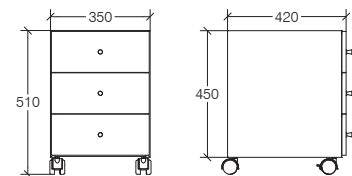

Acciaio inox lucido
Polished stainless steel
Acier inox brillant
Glänzer Edelstahl



Acciaio verniciato
Painted stainless steel
Acier inox laqué
Lackiertem Edelstahl



Laminato
Laminated
Stratifié
Holzlaminat



Acciaio verniciato
Painted stainless steel
Acier inox laqué
Lackiertem Edelstahl



Laminato
Laminated
Stratifié
Holzlaminat



| | | | | | |
|-------------|---------------|------------|---------------|------------|---------------|
| 5436 | .29.29 | .09 | .09.05 | .23 | .23.05 |
| € | 464,00 | 480,00 | 480,00 | 480,00 | 480,00 |

Copribase in mattstone

Mattstone top / Tablette en mattstone / Mattstoneplatte

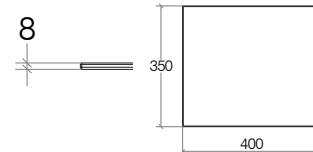
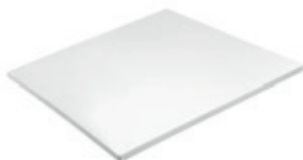

Mattstone
Mattstone
Mattstone
Mattstone



| | |
|-------------|------------|
| 5443 | .26 |
| € | 100,00 |

RUNNER

Base 2 cassetti, con ruote

2 drawers unit, on wheels / Meuble sur roulettes avec 2 tiroirs / Rollcontainer 2 Schubladen

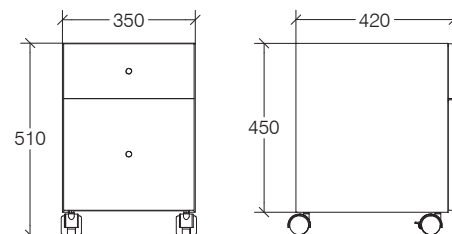

Acciaio inox lucido
Polished stainless steel
Acier inox brillant
Glänzer Edelstahl



Acciaio verniciato
Painted stainless steel
Acier inox laqué
Lackiertem Edelstahl



Laminato
Laminated
Stratifié
Holzlaminat



Acciaio verniciato
Painted stainless steel
Acier inox laqué
Lackiertem Edelstahl



Laminato
Laminated
Stratifié
Holzlaminat



| | | | | | |
|-------------|---------------|------------|---------------|------------|---------------|
| 5438 | .29.29 | .09 | .09.05 | .23 | .23.05 |
| € | 419,00 | 435,00 | 435,00 | 435,00 | 435,00 |

Copribase in mattstone

Mattstone top / Tablette en mattstone / Mattstoneplatte

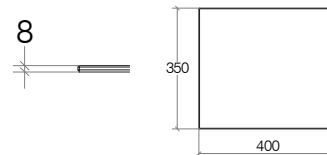
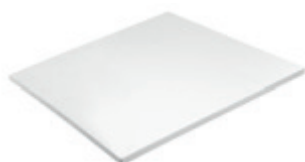

Mattstone
Mattstone
Mattstone
Mattstone



| | |
|-------------|------------|
| 5443 | .26 |
| € | 100,00 |

Carrellino su ruote con tre ripiani

Cart on wheels with three shelves / Desserte sur roulettes avec trois étagères / Rollschrank mit drei Regalen

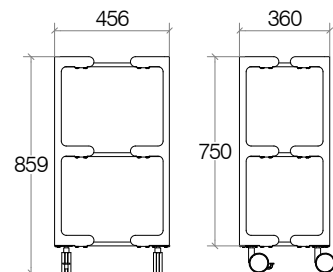

Laminato
Laminated
Stratifié
Holzlaminat

Laminato
Laminated
Stratifié
Holzlaminat

Alluminio verniciato
Painted aluminium
Aluminium laqué
Lackiertem Aluminium

Alluminio verniciato
Painted aluminium
Aluminium laqué
Lackiertem Aluminium



| | | |
|-------------|------------|------------|
| 5450 | .09 | .23 |
| € | 567,00 | 567,00 |

CARETO

Ricambi / Spare parts / Pièces détachées / Ersatzteile

| | | | |
|---------------|------------|---|--------|
| 51502 | R26515021 | Anta completa per art. 51502 - Complete door for art. 51502 | 76,00 |
| | R26515062 | Ripiano vetro temperato 215x124 mm - Tempered glass shelf 215x124 mm | 10,00 |
| | R2251603 | Confezione 4 reggi piano - 4 pins shelf holder set | 6,00 |
| | R51502 | Kit porta calamita - Magnet holder kit | 8,00 |
| | R2250009 | Set 4 viti + 4 tasselli+ 2 ganci specchio revers. - Set 4 screws + 4 plugs + 2 830 hooks for rev. mirror | 7,00 |
| 51504 | R26515041 | Anta completa per art. 51504 - Complete door for art. 51504 | 130,00 |
| | R26515062 | Ripiano vetro temperato 215x124 mm - Tempered glass shelf 215x124 mm | 10,00 |
| | R2251603 | Confezione 4 reggi piano - 4 pins shelf holder set | 6,00 |
| | R51502 | Kit porta calamita - Magnet holder kit | 8,00 |
| | R2250009 | Set 4 viti + 4 tasselli+ 2 ganci specchio revers. - Set 4 screws + 4 plugs + 2 830 hooks for rev. mirror | 7,00 |
| 51505 | R26515052 | Ripiano vetro temperato 124x124 mm - Tempered glass shelf 124x124 mm | 8,00 |
| | R2251603 | Confezione 4 reggi piano - 4 pins shelf holder set | 6,00 |
| | R25515054 | Kit ricambio staffe e gamba - Spare kit for leg and staff | 44,00 |
| 51506 | R26515062 | Ripiano vetro temperato 215x124 mm - Tempered glass shelf 215x124 mm | 10,00 |
| | R2251603 | Confezione 4 reggi piano - 4 pins shelf holder set | 6,00 |
| | R25515064 | Kit ricambio staffe e gamba - Spare kit for leg and st | 120,00 |
| 51511 | R26515112 | Ripiano vetro temperato 365x124 mm - Tempered glass shelf 365x124 mm | 14,00 |
| | R51502 | Kit porta calamita - Magnet holder kit | 8,00 |
| | R2250009 | Set 4 viti + 4 tasselli + 2 ganci specchio reversibile - Set 4 screws + 4 plugs + 2 hooks for rev. mirror | 7,00 |
| 51512 | R26515112 | Ripiano vetro temperato 365x124 mm - Tempered glass shelf 365x124 mm | 14,00 |
| | R51502 | Kit porta calamita - Magnet holder kit | 8,00 |
| | R2250009 | Set 4 viti + 4 tasselli + 2 ganci specchio reversibile - Set 4 screws + 4 plugs + 2 hooks for rev. mirror | 7,00 |
| 5430 | R2500402B | Kit pomolo tondo per anta e cassetto cromo - Round knob for door and drawer chromed | 7,00 |
| | R2254305 | Ruota con freno - Wheel with brake | 8,00 |
| | R2254306 | Ruota - Wheel | 8,00 |
| | R2254308 | Confezione 2 viti + 1 borchia per Runner 2 screws + 1 stud for Runner | 7,00 |
| | R2354301 | Cassetto - Drawer | 34,00 |
| | R240040309 | Kit pomolo quadrato per anta e cassetto bianco - Square knob for door and drawer white | 14,00 |
| | R240040317 | Kit pomolo quadrato per anta e cassetto grigio - Square knob for door and drawer grey | 14,00 |
| | R240040318 | Kit pomolo quadrato per anta e cassetto nero - Square knob for door and drawer black | 14,00 |
| 8293 | R2282931 | kit 4 reggipiano trasparente per colonna girevole 4 transparent pins shelf holder set for swivel cabinet | 14,00 |
| | R26515062 | Ripiano vetro temperato - Tempered glass shelf | 10,00 |
| 8290DX | R2282901 | kit 4 reggipiano con piolino per pensili con anta 4 pins shelf holder set with peg for cabinet with door | 14,00 |
| | R2682901 | Ripiano in vetro per pensili con anta - Tempered glass shelf for cabinet with door | 14,00 |
| 8290SX | R2282901 | kit 4 reggipiano con piolino per pensili con anta 4 pins shelf holder set with peg for cabinet with door | 14,00 |
| | R2682901 | Ripiano in vetro per pensili con anta - Tempered glass shelf for cabinet with door | 14,00 |

Spare parts / Pièces détachées / Ersatzteile / **Ricambi**

| | | | |
|---------------|------------|---|-------|
| 8291DX | R2282901 | kit 4 reggipiano con piolino per pensili con anta 4 pins shelf holder set with peg for cabinet with door | 14,00 |
| | R2682901 | Ripiano in vetro per pensili con anta - Tempered glass shelf for cabinet with door | 14,00 |
| 8291SX | R2282901 | kit 4 reggipiano con piolino per pensili con anta 4 pins shelf holder set with peg for cabinet with door | 14,00 |
| | R2682901 | Ripiano in vetro per pensili con anta - Tempered glass shelf for cabinet with door | 14,00 |
| 5431 | R2500402B | Kit pomolo tondo per anta e cassetto cromo - Round knob for door and drawer chromed | 7,00 |
| | R2254305 | Ruota con freno - Wheel with brake | 8,00 |
| | R2254306 | Ruota - Wheel | 8,00 |
| | R2654342 | Vetro ripiano - Glass shelf | 19,00 |
| | R2251603 | Confezione 4 reggi piano - 4 pins shelf holder set | 6,00 |
| | R2354301 | Cassetto - Drawer | 34,00 |
| | R2254308 | Confezione 2 viti + 1 borchia per Runner 2 screws + 1 stud for Runner | 7,00 |
| | R240040309 | Kit pomolo quadrato per anta e cassetto bianco - Square knob for door and drawer white | 14,00 |
| | R240040317 | Kit pomolo quadrato per anta e cassetto grigio - Square knob for door and drawer grey | 14,00 |
| | R240040318 | Kit pomolo quadrato per anta e cassetto nero - Square knob for door and drawer black | 7,00 |
| 5435 | R2500402B | Kit pomolo tondo per anta e cassetto cromo - Round knob for door and drawer chromed | 7,00 |
| | R2254305 | Ruota con freno - Wheel with brake | 8,00 |
| | R2254306 | Ruota - Wheel | 8,00 |
| | R2654342 | Vetro ripiano - Glass shelf | 19,00 |
| | R2251603 | Confezione 4 reggi piano - 4 pins shelf holder set | 6,00 |
| | R2254308 | Confezione 2 viti + 1 borchia per Runner 2 screws + 1 stud for Runner | 7,00 |
| | R2354301 | Cassetto - Drawer | 34,00 |
| 5436 | R2500402B | Kit pomolo tondo per anta e cassetto cromo - Round knob for door and drawer chromed | 7,00 |
| | R2254305 | Ruota con freno - Wheel with brake | 8,00 |
| | R2254306 | Ruota - Wheel | 8,00 |
| | R2254308 | Confezione 2 viti + 1 borchia per Runner 2 screws + 1 stud for Runner | 7,00 |
| | R2354361 | Cassetto piccolo - Small drawer | 34,00 |
| | R240040309 | Kit pomolo quadrato per anta e cassetto bianco - Square knob for door and drawer white | 14,00 |
| | R240040317 | Kit pomolo quadrato per anta e cassetto grigio - Square knob for door and drawer grey | 14,00 |
| | R240040318 | Kit pomolo quadrato per anta e cassetto nero - Square knob for door and drawer black | 14,00 |



lavabi

washbasins _ vasques _ Waschbecken

Lavabi da appoggio _ 350

Countertop washbasins _ Vasques à poser _ Aufsatzbecken

Lavabi a muro _ 360

wall-mounted washbasins _ Lavabos suspendus _ Wandwaschbecken

Freestanding _ 364

Pedestal washbasins _ Lavabos colonne _ Pedestal Waschbecken

Lavabi ad incasso _ 370

built-in washbasins _ Lavabos encastrés _ Einbauwaschbecken





LAVABI



Lavabi da appoggio

Countertop washbasins _ Vasques à poser _ Aufsatzwaschbecken

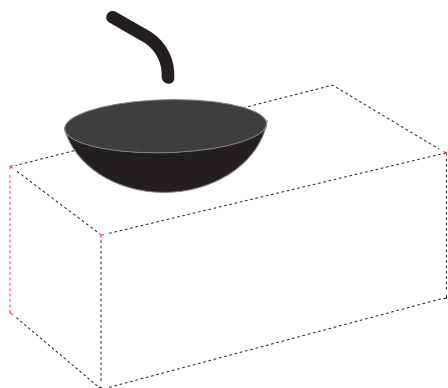

Finiture _ Finishes _ Finitions _ Ausführung:

Ceramica lucida
Polished ceramic
Céramique brillante
Keramik poliert



.09

Ceramica opaca
Matt ceramic
Céramique mate
Keramik matt



.17

Ceramica opaca
Matt ceramic
Céramique mate
Keramik matt



.26

Mattstone
Mattstone
Mattstone
Mattstone



.26

Bambù naturale
Natural bamboo
Bambou naturel
Natürlicher bambus



.03

Acciaio inox lucido
Polished stainless steel
Acier inoxydable brillant
Polierter Edelstahl



.29

MOMON

Lavabo da appoggio con piletta a scarico libero

Countertop washbasin with freeflow wastewater drain / Vasque à poser avec bonde à écoulement libre / Aufsatzbecken mit freie Ablaufgarnitur

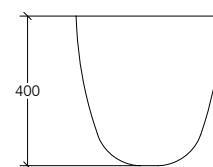
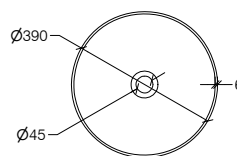

Mattstone
Mattstone
Mattstone
Mattstone



53563

.26

€

584,00

Lavabo da appoggio con piletta a scarico libero

Countertop washbasin, with free waste water drain / Vasque à poser, avec bonde à écoulement libre / Aufsatzbecken mit freie Ablaufgarnitur

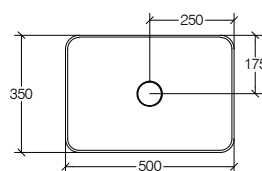

Mattstone
Mattstone
Mattstone
Mattstone



53553

.26

€

429,00

Lavabo da appoggio con piletta a scarico libero

Countertop washbasin with freeflow wastewater drain / Vasque à poser avec bonde à écoulement libre / Aufsatzbecken mit freie Ablaufgarnitur

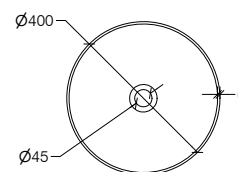

Mattstone
Mattstone
Mattstone
Mattstone



53564

.26

€

494,00

ACQUAIO

Vasca ovale da appoggio senza piletta

Oval countertop washbasin without free waste water drain / Vasque ovale à poser sans bonde / Rundes Aufsatzbecken ohne Ablaufgarnitur

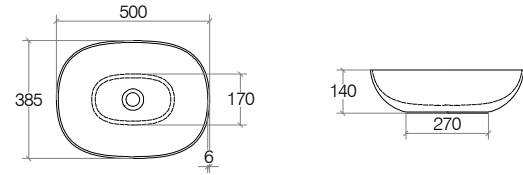

Ceramica lucida
Polished ceramic
Céramique brillante
Keramik poliert

Ceramica opaca
Matt ceramic
Céramique mate
Keramik matt

Ceramica opaca
Matt ceramic
Céramique mate
Keramik matt



| | | | |
|---------------|------------|------------|------------|
| 536982 | .09 | .17 | .26 |
| € | 390,00 | 546,00 | 546,00 |



Vasca ovale da appoggio senza piletta

Oval countertop washbasin without free waste water drain / Vasque ovale à poser sans bonde / Rundes Aufsatzbecken ohne Ablaufgarnitur

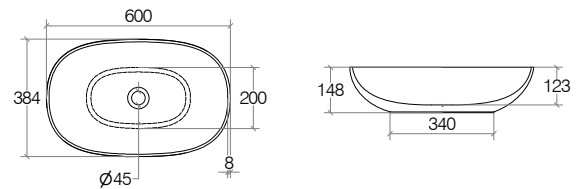

Ceramica lucida
Polished ceramic
Céramique brillante
Keramik poliert

Ceramica opaca
Matt ceramic
Céramique mate
Keramik matt

Ceramica opaca
Matt ceramic
Céramique mate
Keramik matt



| | | | |
|---------------|------------|------------|------------|
| 536983 | .09 | .17 | .26 |
| € | 417,00 | 584,00 | 584,00 |



Vasca ovale da appoggio senza piletta

Oval countertop washbasin without free waste water drain / Vasque ovale à poser sans bonde / Rundes Aufsatzbecken ohne Ablaufgarnitur

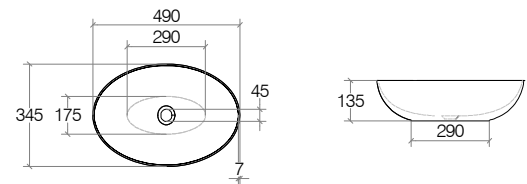

Ceramica lucida
Polished ceramic
Céramique brillante
Keramik poliert

Ceramica opaca
Matt ceramic
Céramique mate
Keramik matt

Ceramica opaca
Matt ceramic
Céramique mate
Keramik matt



| | | | |
|---------------|------------|------------|------------|
| 536985 | .09 | .17 | .26 |
| € | 378,00 | 533,00 | 533,00 |



ACQUAIO

Vasca ovale da appoggio senza piletta

Oval countertop washbasin without free waste water drain / Vasque ovale à poser sans bonde /
Rundes Aufsatzbecken ohne Ablaufgarnitur

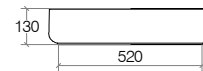
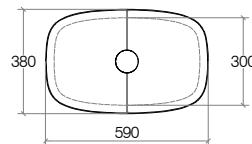

Ceramica lucida
Polished ceramic
Céramique brillante
Keramik poliert



536984

.09

€

572,00

Vasca tonda da appoggio senza piletta

Round countertop washbasin without free waste water drain / Vasque ronde à poser sans bonde /
Ovales Aufsatzbecken ohne Ablaufgarnitur

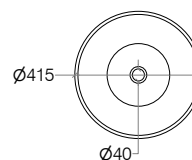

Ceramica lucida
Polished ceramic
Céramique brillante
Keramik poliert



536986

.09

€

344,00

Vasca tonda da appoggio senza piletta

Round countertop washbasin without free waste water drain / Vasque ronde à poser sans bonde /
Ovales Aufsatzbecken ohne Ablaufgarnitur

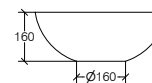
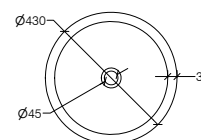

Bambù naturale
Natural bamboo
Bambou naturel
Natürlicher bambus



53694

.03

€

351,00

ACQUAIO

Vasca tonda da appoggio senza piletta

Round countertop washbasin without free waste water drain / Vasque ronde à poser sans bonde / Ovale Aufsatzbecken ohne Ablaufgarnitur

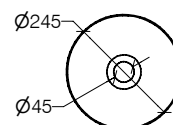

53586



.29

€

149,00

Acciaio inox lucido
Polished stainless steel
Acier inoxydable brillant
Polierter Edelstahl

Vasca tonda da appoggio senza piletta

Round countertop washbasin without free waste water drain / Vasque ronde à poser sans bonde / Ovale Aufsatzbecken ohne Ablaufgarnitur

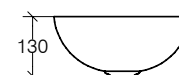
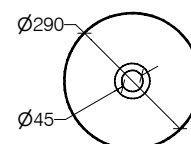

53596



.29

€

170,00

Acciaio inox lucido
Polished stainless steel
Acier inoxydable brillant
Polierter Edelstahl

Vasca tonda da appoggio senza piletta

Round countertop washbasin without free waste water drain / Vasque ronde à poser sans bonde / Ovale Aufsatzbecken ohne Ablaufgarnitur

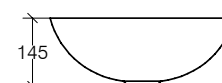
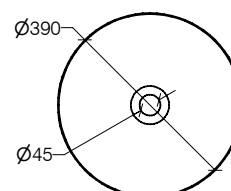

53666



.29

€

312,00

Acciaio inox lucido
Polished stainless steel
Acier inoxydable brillant
Polierter Edelstahl

ACQUAIO _ QUARELO

Vasca tonda da appoggio senza piletta

Round countertop washbasin without free waste water drain / Vasque ronde à poser sans bonde / Ovale Aufsatzbecken ohne Ablaufgarnitur

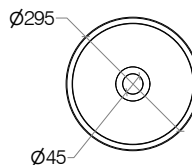

Ceramica lucida
Polished ceramic
Céramique brillante
Keramik poliert

Ceramica opaca
Matt ceramic
Céramique mate
Keramik matt

Ceramica opaca
Matt ceramic
Céramique mate
Keramik matt



| | | | |
|---------------|------------|------------|------------|
| 536981 | .09 | .17 | .26 |
| € | 228,00 | 307,00 | 307,00 |

Vasca tonda da appoggio senza piletta

Round countertop washbasin without free waste water drain / Vasque ronde à poser sans bonde / Ovale Aufsatzbecken ohne Ablaufgarnitur

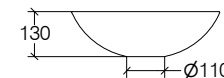
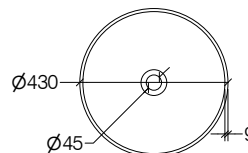

Ceramica lucida
Polished ceramic
Céramique brillante
Keramik poliert

Ceramica opaca
Matt ceramic
Céramique mate
Keramik matt

Ceramica opaca
Matt ceramic
Céramique mate
Keramik matt



| | | | |
|---------------|------------|------------|------------|
| 536991 | .09 | .17 | .26 |
| € | 326,00 | 423,00 | 423,00 |

Lavabo da appoggio con foro rubinetto, senza piletta

Countertop washbasin with tap hole, without waste water drain / Vasque à poser avec perçage de robinetterie, sans bonde / Becken mit Armatur Loch, od. Aufzusetzen

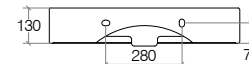
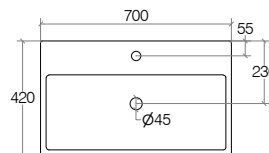

Ceramica lucida
Polished ceramic
Céramique brillante
Keramik poliert

Ceramica opaca
Matt ceramic
Céramique mate
Keramik matt

Ceramica opaca
Matt ceramic
Céramique mate
Keramik matt



| | | | |
|--------------|------------|------------|------------|
| 53710 | .09 | .17 | .26 |
| € | 520,00 | 572,00 | 572,00 |

QUARELO

Lavabo da appoggio, senza piletta

Countertop washbasin, without waste water drain / Vasque à poser, sans bonde / Becken ohne Ablaufgarnitur Wandmontage od. Aufzusetzen

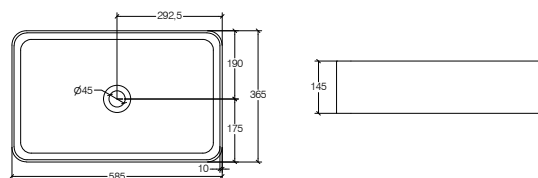

Ceramica lucida
Polished ceramic
Céramique brillante
Keramik poliert

Ceramica opaca
Matt ceramic
Céramique mate
Keramik matt

Ceramica opaca
Matt ceramic
Céramique mate
Keramik matt



| | | | |
|--------------|------------|------------|------------|
| 53703 | .09 | .17 | .26 |
| € | 533,00 | 584,00 | 584,00 |

Lavabo da appoggio con foro rubinetto, senza piletta

Countertop washbasin with tap hole, without waste water drain / Vasque à poser avec perçage de robinetterie, sans bonde / Becken mit Armatur Loch, od. Aufzusetzen

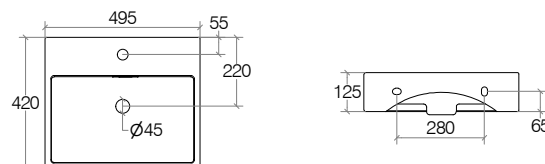

Ceramica lucida
Polished ceramic
Céramique brillante
Keramik poliert

Ceramica opaca
Matt ceramic
Céramique mate
Keramik matt

Ceramica opaca
Matt ceramic
Céramique mate
Keramik matt



| | | | |
|--------------|------------|------------|------------|
| 53709 | .09 | .17 | .26 |
| € | 417,00 | 468,00 | 468,00 |

Lavabo da appoggio con foro rubinetto, senza piletta

Countertop washbasin with tap hole, without waste water drain / Vasque à poser avec perçage de robinetterie, sans bonde / Becken mit Armatur Loch, od. Aufzusetzen

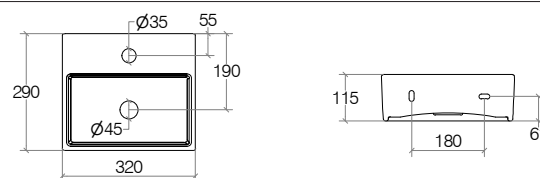

Ceramica lucida
Polished ceramic
Céramique brillante
Keramik poliert

Ceramica opaca
Matt ceramic
Céramique mate
Keramik matt

Ceramica opaca
Matt ceramic
Céramique mate
Keramik matt



| | | | |
|-----------------|------------|------------|------------|
| 53706.29 | .09 | .17 | .26 |
| € | 255,00 | 326,00 | 326,00 |

QUARELO

QUARELO

Lavabo da appoggio senza foro rubinetto, senza piletta

Countertop washbasin without tap hole, without waste water drain

Vasque à poser sans perçage de robinetterie, sans bonde

Becken ohne Armatur Loch, od. Aufzusetzen

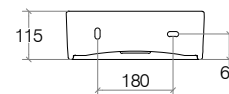
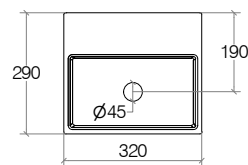

Ceramica lucida
Polished ceramic
Céramique brillante
Keramik poliert



537061.29

.09

€

263,00

Lavabo da appoggio con foro rubinetto, senza piletta

Countertop washbasin with tap hole, without waste water drain

Vasque à poser avec perçage de robinetterie, sans bonde

Becken mit Armatur Loch, od. Aufzusetzen

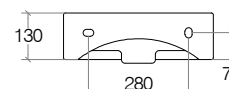
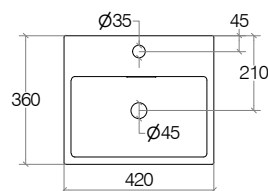

Ceramica lucida
Polished ceramic
Céramique brillante
Keramik poliert



Ceramica opaca
Matt ceramic
Céramique mate
Keramik matt



Ceramica opaca
Matt ceramic
Céramique mate
Keramik matt



53708

.09

.17

.26

€

351,00

403,00

403,00

Lavabo da appoggio senza foro rubinetto, senza piletta

Countertop washbasin without tap hole, without waste water drain

Vasque à poser sans perçage de robinetterie, sans bonde

Becken ohne Armatur Loch, od. Aufzusetzen

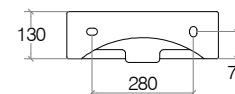
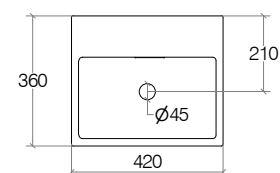

Ceramica lucida
Polished ceramic
Céramique brillante
Keramik poliert



537081

.09

€

351,00

QUARELO



QUARELO

Lavabi a muro

Wall-mounted washbasins _ Lavabos suspendus _ Wandwaschbecken

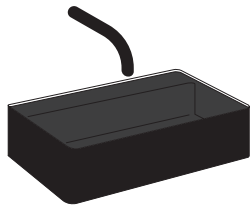
**Finiture** - Finishes - Finitions - Ausführung:**Ceramica lucida**
Polished ceramic
C ramique brillante
Keramik poliert**.09****Ceramica opaca**
Matt ceramic
C ramique mate
Keramik matt**.17****Ceramica opaca**
Matt ceramic
C ramique mate
Keramik matt**.26****Mattstone**
Mattstone
Mattstone
Mattstone**.26**

CIUCI _ POCIA _ QUARELO

Ciuci

Lavabo con supporto, piletta scarico libero Art. 53972, sifone Art. 53922

Washbasin with wall bearing, free waste water drain Art. 53972, siphon Art. 53922 /

Lavabo avec support, bonde à écoulement libre 53972, siphon 53922 /

Becken mit Halterung, freie Ablaufgarnitur 53972, Siphon 53922

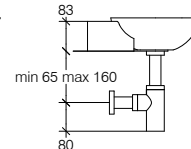
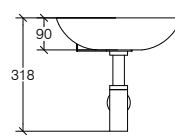
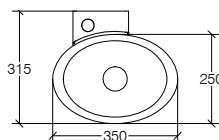

Mattstone
Mattstone
Mattstone
Mattstone



6622

.09

Mattstone
Mattstone
Mattstone
Mattstone



.17

€

436,00

436,00

Pocia

Lavabo con supporto, piletta scarico libero Art. 53972, sifone Art. 53922

Washbasin with wall bearing, free waste water drain Art. 53972, siphon Art. 53922 /

Lavabo avec bonde à écoulement libre 53972, siphon 53922 /

Becken mit Ablaufgarnitur 53972 und Siphon 53922

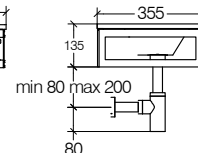
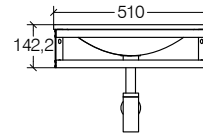
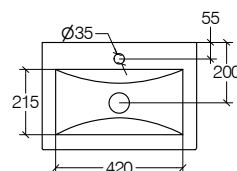

Vetro
Glass
Verre
Glasse



665801.29

.83

€

797,00

Quarelo

Lavabo a muro con foro rubinetto, senza piletta

Wall washbasin with tap hole, without waste water drain /

Lavabo à accrocher au mur avec perçage de robinetterie, sans bonde /

Becken mit Armatur Loch, od. Aufzusetzen

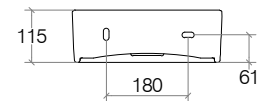
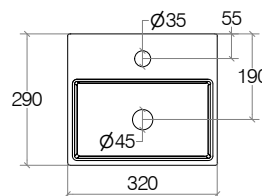

Ceramica lucida
Polished ceramic
Céramique brillante
Keramik poliert



53706.29

.09

Ceramica opaca
Matt ceramic
Céramique mate
Keramik matt



.17

Ceramica opaca
Matt ceramic
Céramique mate
Keramik matt



.26

€

255,00

326,00

326,00



QUARELO

Lavabo a muro senza foro rubinetto, senza troppopieno e piletta

Wall washbasin without tap hole, without overflow and waste water drain /

Lavabo mural sans perçage de robinetterie, sans trop-plein et bonde /

Keramikbecken ohne Loch für Armatur, ohne Überlauf, od. Aufzusetzen

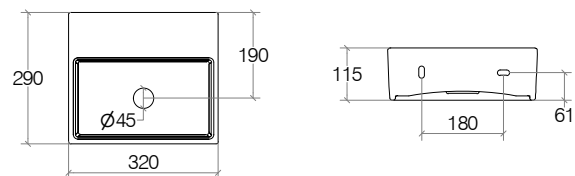

Ceramica lucida
Polished ceramic
Céramique brillante
Keramik poliert



537061.29

.09

€

263,00



Lavabo a muro con foro rubinetto, senza piletta

Wall washbasin with tap hole, without waste water drain /

Lavabo à accrocher au mur avec perçage de robinetterie, sans bonde /

Becken mit Armatur Loch, od. Aufzusetzen

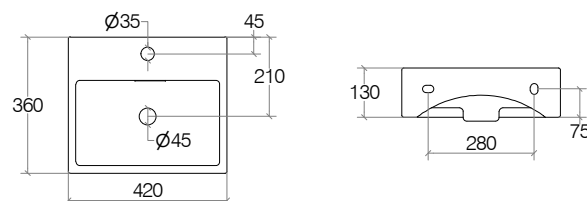

Ceramica lucida
Polished ceramic
Céramique brillante
Keramik poliert

Ceramica opaca
Matt ceramic
Céramique mate
Keramik matt

Ceramica opaca
Matt ceramic
Céramique mate
Keramik matt



53708

.09

.17

.26

€

351,00

403,00

403,00



Lavabo a muro senza foro rubinetto, senza piletta

Wall washbasin without tap hole, without waste water drain /

Lavabo à accrocher au mur sans perçage de robinetterie, sans bonde /

Keramikbecken ohne Loch für Armatur, od. Aufzusetzen

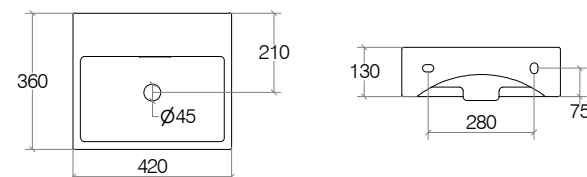

Ceramica lucida
Polished ceramic
Céramique brillante
Keramik poliert



537081

.09

€

351,00



QUARELO

Lavabo a muro, senza piletta

Wall washbasin, without waste water drain /

Lavabo à accrocher au mur, sans bonde /

Becken ohne Ablaufgarnitur Wandmontage od. Aufzusetzen

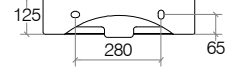
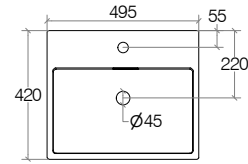

Ceramica lucida
Polished ceramic
Céramique brillante
Keramik poliert

Ceramica opaca
Matt ceramic
Céramique mate
Keramik matt

Ceramica opaca
Matt ceramic
Céramique mate
Keramik matt



| | | | |
|--------------|------------|------------|------------|
| 53709 | .09 | .17 | .26 |
| € | 417,00 | 468,00 | 468,00 |

Lavabo a muro senza foro rubinetto, senza piletta

Wall washbasin without tap hole, without waste water drain /

Lavabo à accrocher au mur sans perçage de robinetterie, sans bonde /

Becken ohne Ablaufgarnitur Wandmontage od ohne loch für armatur. Aufzusetzen

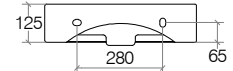
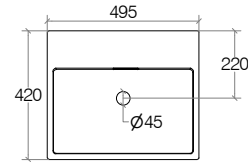

Ceramica lucida
Polished ceramic
Céramique brillante
Keramik poliert



| | |
|---------------|------------|
| 537091 | .09 |
| € | 417,00 |

Lavabo a muro, senza piletta

Wall washbasin, without waste water drain /

Lavabo à accrocher au mur, sans bonde /

Becken ohne Ablaufgarnitur Wandmontage od. Aufzusetzen

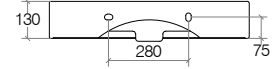
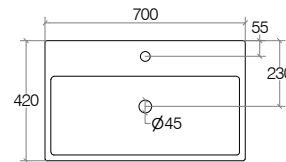

Ceramica lucida
Polished ceramic
Céramique brillante
Keramik poliert

Ceramica opaca
Matt ceramic
Céramique mate
Keramik matt

Ceramica opaca
Matt ceramic
Céramique mate
Keramik matt



| | | | |
|--------------|------------|------------|------------|
| 53710 | .09 | .17 | .26 |
| € | 520,00 | 572,00 | 572,00 |



Lavabi freestanding

Freestanding washbasins _ Lavabos colonne _ Freistehende waschbecken

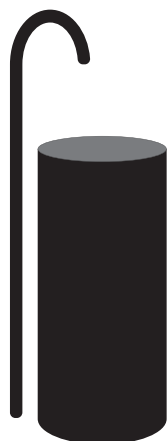

Finiture _ Finishes _ Finitions _ Ausführung:

Mattstone

Mattstone
Mattstone
Mattstone



.26

Acciaio verniciato

Painted steel
Acier peint
Lackierter Stahl



.23

Azzurro

Azure
Azur
Azurblau



.76

Grigio

Grey
Gris
Grau



.95

Tortora

Tortora
Tortora
Tortora



.99

FREESTANDING

FÒRA

Lavabo da interno/esterno. Realizzato in materiale riciclato non verniciato

Indoor/outdoor washbasin. Made of unpainted recycled material

Lavabo autoportant pour intérieur/extérieur. Fabriqué en matériau recyclé non peint

Waschbecken für den Innen- und Außenbereich. Hergestellt aus unlackiertem recyceltem Material

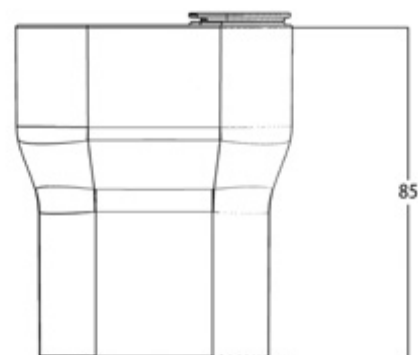
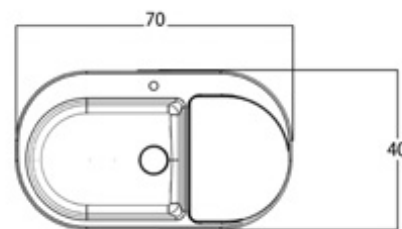

Il lavabo può essere installato a parete (indoor) con relativo kit da acquistare separatamente cod. A53565K1, o in appoggio (outdoor) con apposito kit da acquistare separatamente cod. A53565K2.

Il rubinetto non è incluso nell'imballo.

The washbasin can be wall-mounted (indoor) with the relevant kit to be purchased separately code A53565K1, or free-standing (outdoor) with kit to be purchased separately code A53565K2. The tap is not included in the package.

Le lavabo peut être fixé au mur (indoor) avec le kit correspondant à acheter séparément code A53565K1, ou sur pied (outdoor) avec le kit à acheter séparément code A53565K2. Le robinet n'est pas inclus dans l'emballage.

Der Waschtisch kann an der Wand montiert werden (innen) mit dem entsprechenden, separat zu erwerbenden Bausatz Code A53565K1, oder freistehend (im Freien) mit dem separat zu erwerbenden Bausatz, Code A53565K2. Der Wasserhahn ist nicht in der Verpackung enthalten.

Azzurro
Azure
Azur
Azurblau

Grigio
Grey
Gris
Grau

Tortora
Tortora
Tortora
Tortora

**new****53565****.76****.95****.99**

€

617,00

617,00

617,00



Kit fissaggio a parete, include staffa e sifone

Wall fixing kit, includes bracket and siphon

Kit de fixation murale, comprend le support mural et le siphon

Wandbefestigungskit, inklusive Halterung und Siphon

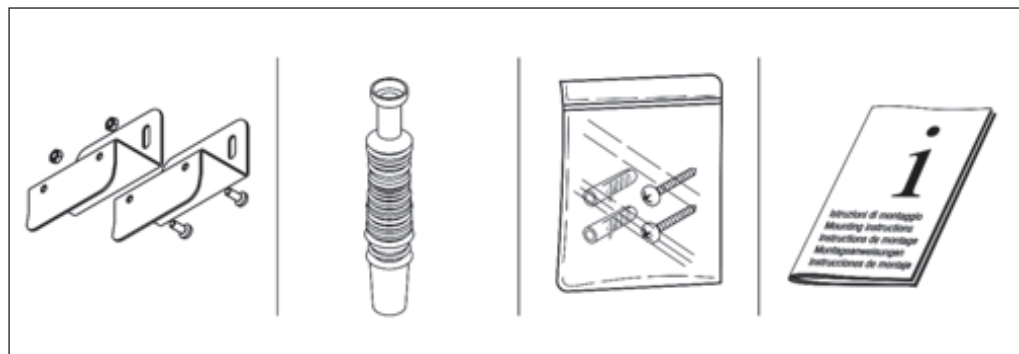

new

A53565K1

€

52,00

Kit fissaggio da appoggio, include tubo di scarico e tubo di collegamento all'acqua

Fixing kit for standing, includes drain hose and water connection hose

Kit de fixation sur pied - en appui sur le sol, comprend un tuyau d'évacuation et un tuyau de raccordement à l'eau

Bausatz für die Oberflächenmontage, inklusive Ablaufschlauch und Wasseranschlusschlauch

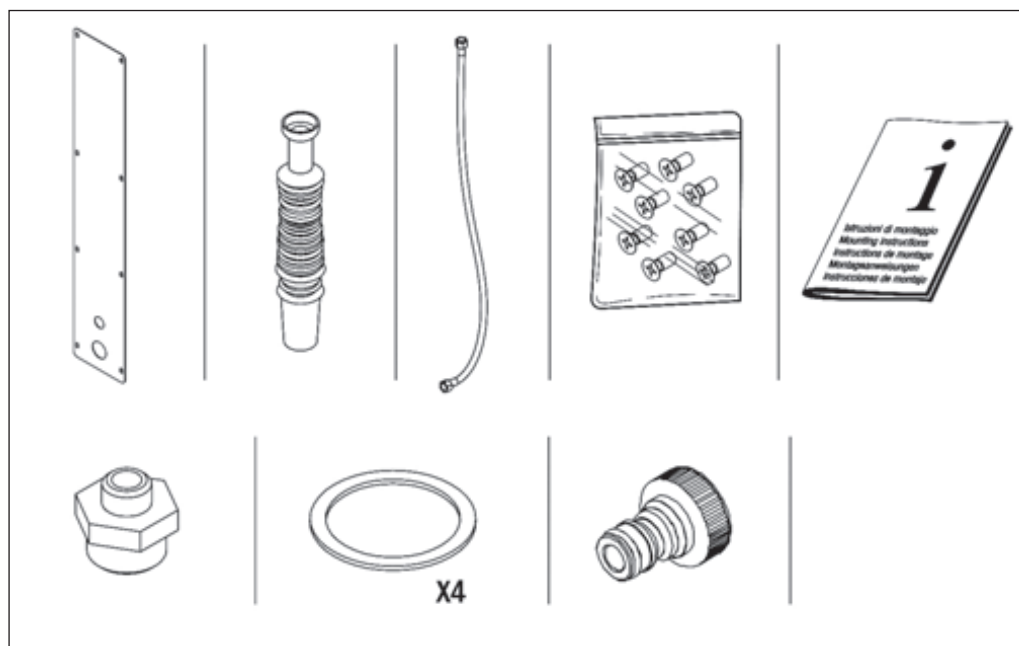

new

A53565K2

€

103,00

MOMON

Lavabo centro stanza con foro rubinetto, completo di piletta a scarico libero

Pedestal washbasin, with tap hole, with freeflow waste water drain

Lavabo colonne, avec perçage de robinetterie, bonde à écoulement libre

Piedestal Waschbecken mit Hahnloch und freie Ablaufgarnitur

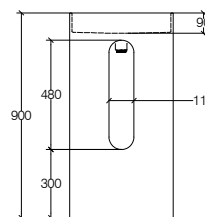
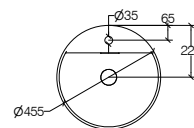

Mattstone
Mattstone
Mattstone
Mattstone



53559

.26

€

1556,00

Lavabo centro stanza senza foro rubinetto, completo di piletta a scarico libero e sifone a pavimento

Pedestal washbasin, without tap hole, with free waste water drain and floor siphon

Lavabo colonne sans trou de robinetterie, avec bonde à écoulement libre et siphon au sol

Piedestal Waschbecken ohne Hahnloch mit freie Ablaufgarnitur und Siphon am Boden

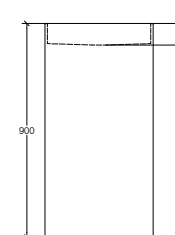
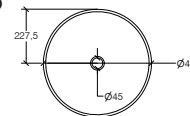

senza foro rubinetto
without tap hole
sans trou de robinetterie
ohne loch für armatur



Mattstone
Mattstone
Mattstone
Mattstone



53560

.26

€

1556,00

CADIN

Struttura freestanding per lavabo 53564.26

Freestanding structure for washbasin 53564.26 / Structure indépendante pour vasque 53564.26
Freistehende Struktur für Aufsatzbecken 53564.26

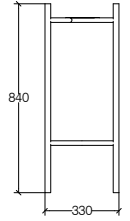
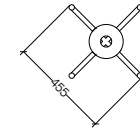

Acciaio verniciato
Painted steel
Acier peint
Lackierter Stahl



| | |
|-------------|------------|
| 6663 | .23 |
| € | 616,00 |

Lavabo da appoggio con piletta a scarico libero

Countertop washbasin with freeflow wastewater drain / Vasque à poser avec bonde à écoulement libre / Aufsatzbecken mit freie Ablaufgarnitur

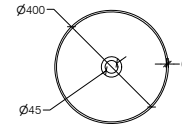

Mattstone
Mattstone
Mattstone
Mattstone



| | |
|--------------|------------|
| 53564 | .26 |
| € | 494,00 |

Mensola

Shelf / Étagère / Ablage

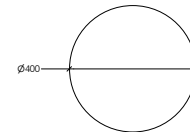

Mattstone
Mattstone
Mattstone
Mattstone



| | |
|--------------|------------|
| 66631 | .26 |
| € | 151,00 |



| | |
|--------------------------------------|---------|
| 6663.22 + 53564.26 + 66631.26 | |
| € | 1261,00 |



CADIN



Lavabi ad incasso

Built-in washbasins _ Lavabos encastrés _ Einbauwaschbecken

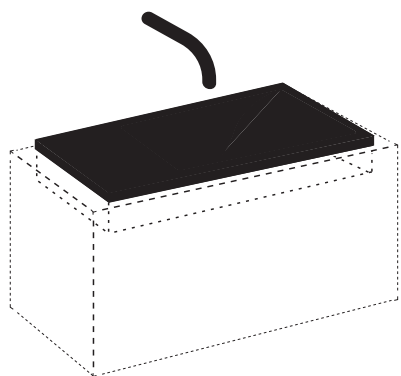

Finiture _ Finishes _ Finitions _ Ausführung:

Acciaio inox lucido
Polished stainless steel
Acier inoxydable brillant
Polierter Edelstahl



.29

ACQUAIO

Vasca da incasso

Built-in washbasin / Lavabo à encastrer / Einbauwaschtisch

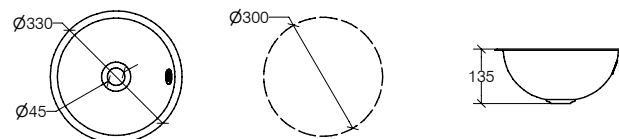

Acciaio inox
Stainless steel
Acier inoxydable
Rostfreier stahl

**53593****.29**

€

154,00

Vasca da incasso

Built-in washbasin / Lavabo à encastrer / Einbauwaschtisch

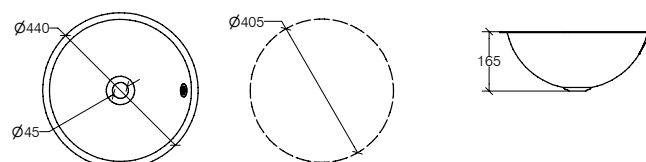

Acciaio inox
Stainless steel
Acier inoxydable
Rostfreier stahl

**53663****.29**

€

264,00

Ricambi _ Spare parts _ Pièces détachées _ Ersatzteile

| | | | |
|--------------|----------|---|---------------|
| 53553 | R2253599 | Spugna abrasiva - Abrasive sponge | 7,00 |
| 53559 | R2253599 | Spugna abrasiva - Abrasive sponge | 7,00 |
| 53560 | R2253599 | Spugna abrasiva - Abrasive sponge | 7,00 |
| 53563 | R2253599 | Spugna abrasiva - Abrasive sponge | 7,00 |
| 53564 | R2253599 | Spugna abrasiva - Abrasive sponge | 7,00 |
| 53593 | R2253601 | Kit troppopieno - Overflow set | 19,00 |
| 53663 | R2253601 | Kit troppopieno - Overflow set | 19,00 |
| 53565 | R53565 | Coperchio inferiore - Lower cover | 110,00 |
| | R5356501 | Coperchio superiore - Upper cover | 128,00 |
| | R5356502 | Kit 4 piedini d.25x14xm8 nero - Kit of 4 feet d.25x14xm8 black | 10,00 |
| | R5356503 | Tappo scarico + guarnizione klingrer - Drain plug + Klingrer gasket | 10,00 |

termoarredi

Design Radiators _ Radiateurs _ Heizkörper

Termoarredi elettrici _ 378

Electric radiators _ Radiateurs électriques _ Heizkörper elektrischer

Termoarredi ad acqua _ 380

Hydraulic radiators _ Radiateurs hydrauliques _ Heizkörper mit Wasser

Finiture _ Finishes _ Finitions _ Ausführung:

Acciaio al carbonio bianco

RAL 9016

White carbon steel
Acier au carbone blanc
Karbonstahl Weiß

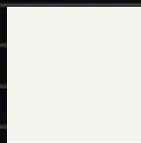

.09

Acciaio al carbonio antracite

RAL 7016

Anthracite carbon steel
Acier au carbone anthracite
Karbonstahl Anthrazit

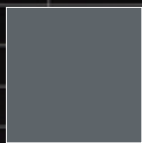

.17

Acciaio al carbonio nero

RAL9005

Black carbon steel
Acier au carbone noir
Karbonstahl Schwarz

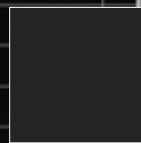

.18

Acciaio inox cromato

Chromed stainless steel
Acier inoxydable chromé
Verchromtes Edelstahl

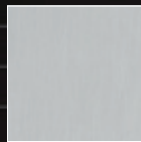

.29

Acciaio inox spazzolato

Brushed stainless steel
Acier inoxydable brossé
Gebürsteter Edelstahl

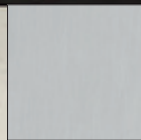

.32



CALIGO

7

Spessore 7 mm

7 mm thickness
7 mm épaisseur
7 mm Dicke

**Design essenziale**

Essential design
Design essentiel
Schlichtes Design

**Alta efficienza energetica**

High energy efficiency
Haute efficacité énergétique
Hohe Energieeffizienz

**Saldatura laser**

Laser welding
Soudage laser
Laserschweißen

**Uso versatile**

Versatile placing
Utilisation polyvalente
Vielseitig Platzierung

**Portasalviette**

Towel holder
Porte-serviettes
Handtuchhalter

**Facile da installare**

Easy to install
Facile à installer
Einfach zu installieren

**Facile da pulire**

Easy to clean
Facile à nettoyer
Einfach zu säubern

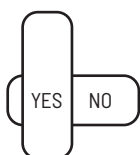
**Installabile solo in verticale**

Installation only in vertical
Installation uniquement en vertical
Installation nur vertikal





CALIGO

CALIGO

Termoarredo elettrico a muro. Resistenza non inclusa

Electric radiator. Resistance not included / Radiateur électrique. Résistance non incluse
Elektrischer Heizkörper. Widerstand nicht enthalten

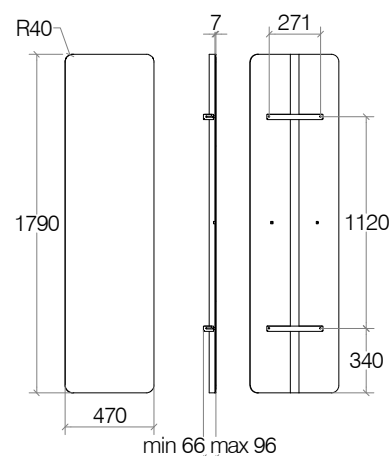

| Resa Termica / Thermal Efficiency | Peso |
|---|-------------|
| resistenza / resistance 5211, 5212 | Weight |
| Watt | kg |
| max 800 | 26,5 |

| Assi Idraulici da centro a centro | Assi montaggio orizzontali | Assi montaggio verticali | Da inizio montaggio a fine prodotto |
|-----------------------------------|----------------------------|--------------------------|-------------------------------------|
| Hydraulic axes center to center | Horizontal mounting axes | Vertical mounting axes | From mounting start to product end |
| mm | mm | mm | mm |
| - | 270 | 1120 | 1450 |

Acciaio al carbonio bianco RAL 9016
White carbon steel
Acier au carbone blanc
Karbonstahl Weiß

Acciaio al carbonio antracite RAL 7016
Anthracite carbon steel
Acier au carbone anthracite
Karbonstahl Anthrazit

Acciaio al carbonio nero RAL9005
Black carbon steel
Acier au carbone noir
Karbonstahl Schwarz



Con copertura staffe inclusa nell'imballo
With bracket cover included in the package
Avec chaches fixations inclus dans l'emballage
Mit im Paket enthaltener Abdeckung



| 75041 | .09 | .17 | .18 |
|-------|--------|--------|--------|
| € | 871,00 | 871,00 | 871,00 |

CALIGO

Termoarredo elettrico a muro. Resistenza non inclusa

Electric radiator. Resistance not included / Radiateur électrique. Résistance non incluse
Elektrischer Heizkörper. Widerstand nicht enthalten

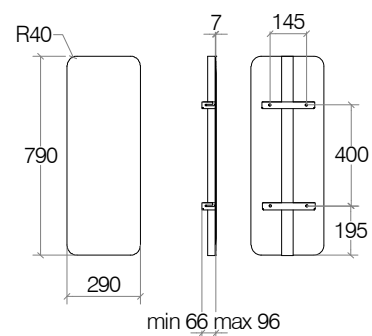

| Resa Termica / Thermal Efficiency | Peso |
|-------------------------------------|-------------|
| resistenza / resistance 5213 | Weight |
| Watt | kg |
| max 200 | 11,7 |

| Assi Idraulici da centro a centro | Assi montaggio orizzontali | Assi montaggio verticali | Da inizio montaggio a fine prodotto |
|-----------------------------------|----------------------------|--------------------------|-------------------------------------|
| Hydraulic axes center to center | Horizontal mounting axes | Vertical mounting axes | From mounting start to product end |
| mm | mm | mm | mm |
| - | 145 | 400 | 595 |

Acciaio al carbonio bianco RAL 9016
White carbon steel
Acier au carbone blanc
Karbonstahl Weiß

Acciaio al carbonio antracite RAL 7016
Anthracite carbon steel
Acier au carbone anthracite
Karbonstahl Anthrazit

Acciaio al carbonio nero RAL 9005
Black carbon steel
Acier au carbone noir
Karbonstahl Schwarz



Con copertura staffe inclusa nell'imballo
With bracket cover included in the package
Avec chaches fixations inclus dans l'emballage
Mit im Paket enthaltener Abdeckung



| | | | |
|--------------|------------|------------|------------|
| 75051 | .09 | .17 | .18 |
| € | 533,00 | 533,00 | 533,00 |

CALIGO

Termoarredo idraulico a muro

Hydraulic radiator / Radiateur hydraulique / Hydraulischer Heizkörper

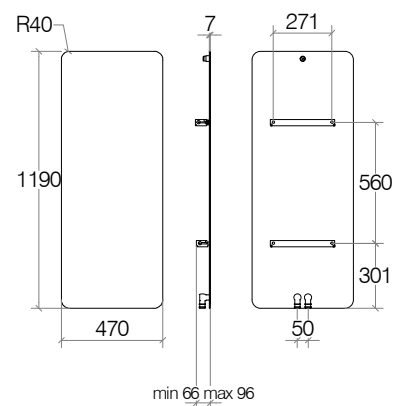

| Resa Termica / Thermal Efficiency | | | | Esponente | Volume acqua | Peso |
|-----------------------------------|------------------------------------|-----------------|-----------------|---------------|-----------------|-------------|
| $\Delta T = 50K$ | $\Delta T = 60K$ | 70/55/24 | 55/45/24 | Exponent | Water volume | Weight |
| (EN 442) | | | | | | |
| Watt | Watt | Watt | Watt | n | dm ³ | kg |
| 523 | 662 | 373 | 225 | 1,2907 | 1,1 | 17,5 |

| Assi Idraulici da centro a centro | Assi montaggio orizzontali | Assi montaggio verticali | Da inizio montaggio a fine prodotto |
|-----------------------------------|----------------------------|--------------------------|-------------------------------------|
| Hydraulic axes center to center | Horizontal mounting axes | Vertical mounting axes | From mounting start to product end |
| mm | mm | mm | mm |
| 50 (looking up) | 270 | 560 | 860 |

Acciaio al carbonio bianco RAL 9016
White carbon steel
Acier au carbone blanc
Karbonstahl Weiß

Acciaio al carbonio antracite RAL 7016
Anthracite carbon steel
Acier au carbone anthracite
Karbonstahl Anthrazit

Acciaio al carbonio nero RAL9005
Black carbon steel
Acier au carbone noir
Karbonstahl Schwarz



Con copertura staffe inclusa nell'imballo
With bracket cover included in the package
Avec chaches fixations inclus dans l'emballage
Mit im Paket enthaltener Abdeckung



| | | | |
|--------------|------------|------------|------------|
| 75011 | .09 | .17 | .18 |
| € | 563,00 | 563,00 | 563,00 |

Termoarredo idraulico a muro

Hydraulic radiator / Radiateur hydraulique / Hydraulischer Heizkörper

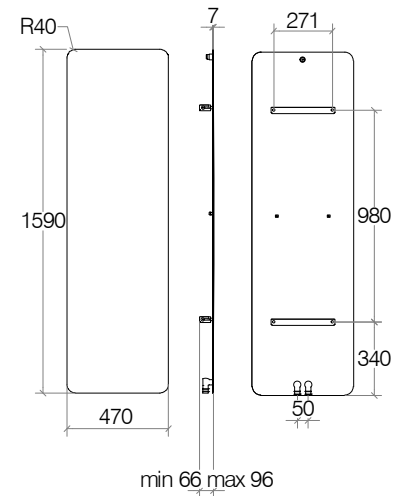

| Resa Termica / Thermal Efficiency | | | | Esponente | Volume acqua | Peso |
|-----------------------------------|------------------------------------|-----------------|-----------------|---------------|-----------------|-----------|
| $\Delta T = 50K$ | $\Delta T = 60K$ | 70/55/24 | 55/45/24 | Exponent | Water volume | Weight |
| (EN 442) | | | | | | |
| Watt | Watt | Watt | Watt | n | dm ³ | kg |
| 700 | 886 | 500 | 302 | 1,2907 | 1,5 | 23 |

| Assi Idraulici da centro a centro | Assi montaggio orizzontali | Assi montaggio verticali | Da inizio montaggio a fine prodotto |
|-----------------------------------|----------------------------|--------------------------|-------------------------------------|
| Hydraulic axes center to center | Horizontal mounting axes | Vertical mounting axes | From mounting start to product end |
| mm | mm | mm | mm |
| 50 (looking up) | 270 | 980 | 1320 |

Acciaio al carbonio bianco RAL 9016
White carbon steel
Acier au carbone blanc
Karbonstahl Weiß

Acciaio al carbonio antracite RAL 7016
Anthracite carbon steel
Acier au carbone anthracite
Karbonstahl Anthrazit

Acciaio al carbonio nero RAL 9005
Black carbon steel
Acier au carbone noir
Karbonstahl Schwarz



Con copertura staffe inclusa nell'imballo
With bracket cover included in the package
Avec chaches fixations inclus dans l'emballage
Mit im Paket enthaltener Abdeckung



| | | | |
|--------------|------------|------------|------------|
| 75021 | .09 | .17 | .18 |
| € | 750,00 | 750,00 | 750,00 |

CALIGO

Termoarredo idraulico a muro

Hydraulic radiator / Radiateur hydraulique / Hydraulischer Heizkörper

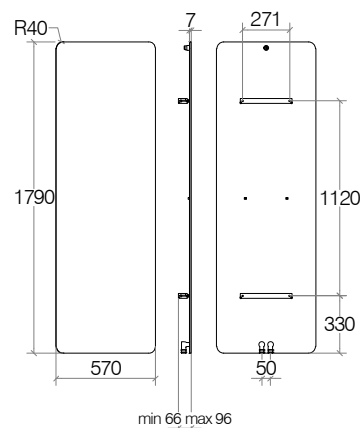

| Resa Termica / Thermal Efficiency | | | | Esponente | Volume acqua | Peso |
|-----------------------------------|------------------------------------|-----------------|-----------------|---------------|-----------------|-----------|
| $\Delta T = 50K$ | $\Delta T = 60K$ | 70/55/24 | 55/45/24 | Exponent | Water volume | Weight |
| (EN 442) | | | | | | |
| Watt | Watt | Watt | Watt | n | dm ³ | kg |
| 960 | 1214 | 685 | 413 | 1,2882 | 2 | 31 |

| Assi Idraulici da centro a centro | Assi montaggio orizzontali | Assi montaggio verticali | Da inizio montaggio a fine prodotto |
|-----------------------------------|----------------------------|--------------------------|-------------------------------------|
| Hydraulic axes center to center | Horizontal mounting axes | Vertical mounting axes | From mounting start to product end |
| mm | mm | mm | mm |
| 50 (looking up) | 270 | 1120 | 1450 |

Acciaio al carbonio bianco RAL 9016
White carbon steel
Acier au carbone blanc
Karbonstahl Weiß

Acciaio al carbonio antracite RAL 7016
Anthracite carbon steel
Acier au carbone anthracite
Karbonstahl Anthrazit

Acciaio al carbonio nero RAL 9005
Black carbon steel
Acier au carbone noir
Karbonstahl Schwarz



Con copertura staffe inclusa nell'imballo
With bracket cover included in the package
Avec chaches fixations inclus dans l'emballage
Mit im Paket enthaltener Abdeckung



| 75031 | .09 | .17 | .18 |
|-------|--------|--------|--------|
| € | 862,00 | 862,00 | 862,00 |

Portasalvietta per termoarredo 470 mm

Towel bar for radiator 470 mm / Barre porte-serviettes pour radiateur 470 mm / Handtuchhalter für Heizkörper 470 mm



Acciaio inox verniciato
Painted stainless steel
Acier inoxydable verni
Lackiertem Edelstahl

Acciaio inox verniciato
Painted stainless steel
Acier inoxydable verni
Lackiertem Edelstahl

Acciaio inox verniciato
Painted stainless steel
Acier inoxydable verni
Lackiertem Edelstahl

Acciaio inox cromato
Chromed stainless steel
Acier inoxydable chromé
Verchromtes Edelstahl

Acciaio inox spazzolato
Brushed stainless steel
Acier inoxydable brossé
Gebürsteter Edelstahl

| | .09 | .17 | .18 | .29 | .32 |
|-------------|------------|------------|------------|------------|------------|
| 7509 | | | | | |
| € | 55,00 | 55,00 | 55,00 | 55,00 | 55,00 |

Portasalvietta per termoarredo ad acqua

Towel bar for water radiator / Barre porte-serviettes pour radiateur eau chaude / Handtuchhalter für Heizkörper

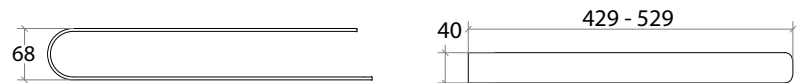

Acciaio inox verniciato
Painted stainless steel
Acier inoxydable verni
Lackiertem Edelstahl

Acciaio inox verniciato
Painted stainless steel
Acier inoxydable verni
Lackiertem Edelstahl

Acciaio inox verniciato
Painted stainless steel
Acier inoxydable verni
Lackiertem Edelstahl

Acciaio inox cromato
Chromed stainless steel
Acier inoxydable chromé
Verchromtes Edelstahl

Acciaio inox spazzolato
Brushed stainless steel
Acier inoxydable brossé
Gebürsteter Edelstahl

| | .09 | .17 | .18 | .29 | .32 |
|-------------|--------------|------------|------------|------------|------------|
| L | | | | | |
| COD. | | | | | |
| 470 | 75092 | 55,00 | 55,00 | 55,00 | 55,00 |
| 570 | 75093 | 61,00 | 61,00 | 61,00 | 61,00 |

CALIGO

Resistenza elettrica on / off, - 230 V

On/off electrical resistance / Résistance électrique on/off / Elektrischer Widerstand on/off

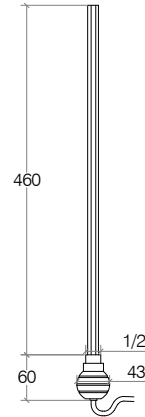

ABS
ABS
ABS
ABS

| WATT | COD | .09 |
|------|------|--------|
| 200 | 7514 | 120,00 |
| 800 | 7511 | 134,00 |

Resistenza elettrica con timer e regolazione temperatura, 800 W - 230 V

Heating element for electrical radiators with timer and temperature control

Résistance électrique avec timer et régulateur de température

Elektrischer Widerstand mit Timer und Temperaturregelung

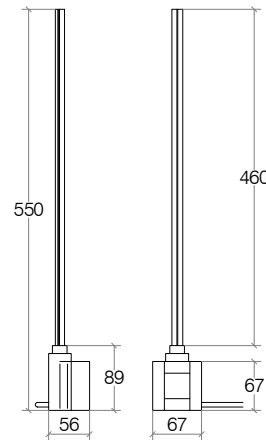

ABS
ABS
ABS
ABS

| | |
|------|--------|
| 7512 | .09 |
| € | 256,00 |

Resistenza elettrica con timer e regolazione temperatura, 200 W - 230 V

Heating element for electrical radiators with timer and temperature control

Résistance électrique avec timer et régulateur de température

Elektrischer Widerstand mit Timer und Temperaturregelung

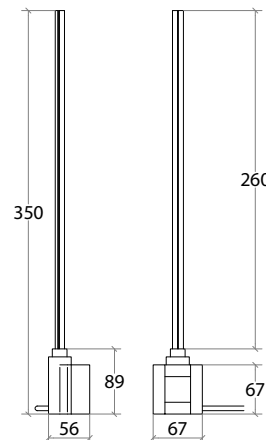

ABS
ABS
ABS
ABS

| | |
|------|--------|
| 7513 | .09 |
| € | 256,00 |

CALIGO

Gruppo valvola e detentore 50 mm - destro

Thermostatic lockshield valve 50 mm - right / Groupe vanne et détendeur, 50 mm, droit / Ventile Detentoren 50 mm rechts

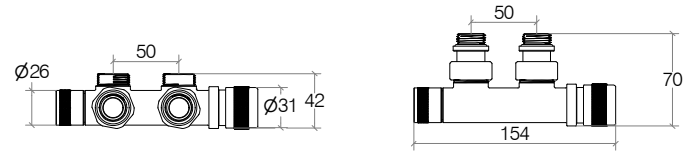

Ottone cromato
Chromed brass
Laiton chromé
Verchromtes Messing



7510

.29

€

150,00

**Testa termostatica per gruppo valvola**

Thermostatic head for valve group / Vanne thermostatique / Ventile Thermostatisch

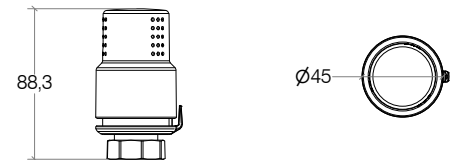

ABS cromato
Chromed ABS
ABS chromé
Verchromtes ABS



7515

.29

€

76,00

**Kit copritubo 50 mm**

Tube cover kit 50 mm / Kit cache-tuyau 50 mm / Rohrabdeckungs-Set 50 mm

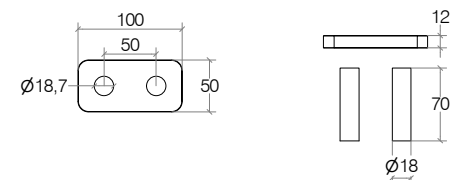

Ottone cromato
Chromed brass
Laiton chromé
Verchromtes Messing



7516

.29

€

61,00



CALIGO**Kit raccordi per tubo rame e multistrato**

Copper and multilayer collar kit / Kit raccords pour tuyaux / Anschlussstück aus Kupfer

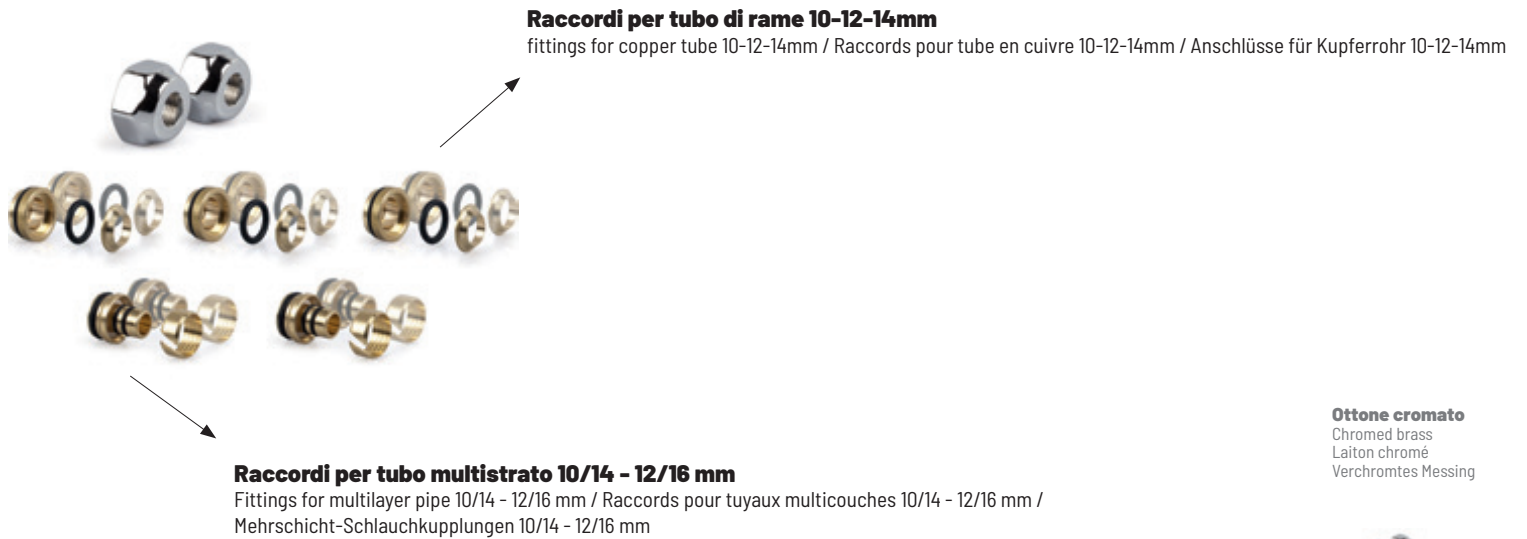

Ottone cromato
Chromed brass
Laiton chromé
Verchromtes Messing



| | |
|-------------|--------------|
| 7517 | .29 |
| € | 41,00 |

Ricambi / Spare parts / Pièces détachées / Ersatzteile

| | | | |
|--------------|------------|--|--------|
| 75011 | R247501109 | Kit copertura staffe bianche 1190x470 - White bracket cover kit 1190x470 | 121,00 |
| | R247501117 | Kit copertura staffe grigio 1190x470 - Grey bracket cover kit 1190x470 | 121,00 |
| | R247501118 | Kit copertura staffe nero 1190x470 - Black bracket cover kit 1190x470 | 121,00 |
| 75021 | R247502109 | Kit copertura staffe bianco 1590X470 - White bracket cover kit 1590X470 | 121,00 |
| | R247502117 | Kit copertura staffe grigio 1590X470 - Grey bracket cover kit 1590X470 | 121,00 |
| | R247502118 | Kit copertura staffe nero 1590X470 - Black bracket cover kit 1590X470 | 121,00 |
| 75031 | R247503109 | Kit copertura staffe bianco 1790X570 - White bracket cover kit 1790X570 | 132,00 |
| | R247503117 | Kit copertura staffe grigio 1790X570 - Grey bracket cover kit 1790X570 | 132,00 |
| | R247503118 | Kit copertura staffe nero 1790X570 - Black bracket cover kit 1790X570 | 132,00 |
| 75041 | R2875122 | Resistenza 800w x controller ktx4 bianco - Resistance 800w x KTX4 white controller | 83,00 |
| 75051 | R2875131 | Resistenza 200w x controller ktx4 bianco - Resistance 200w x KTX4 white controller | 83,00 |



Sifoni, Pilette & Rubinetteria

Siphons, water drains, taps and fittings
Siphons, bondes et robinetterie
Siphons, Ablaufgarnituren und Armaturen

Sifoni _ 390

Siphons _ Siphons _ Siphons

Pilette _ 392

Water drains _ Bondes _ Ablaufgarnituren

Prese acqua _ 395

Water outlet _ Sorties d'eau _ Wandanschlussbogen

Rubinetteria _ 397

Taps and fittings _ Robinetterie _ Armaturen

BUSI E CANE

Sifone 1"-1/4 mm

Siphon, 1"-1/4 mm / Siphon 1"1/4 mm / Siphon 1" 1/4 mm

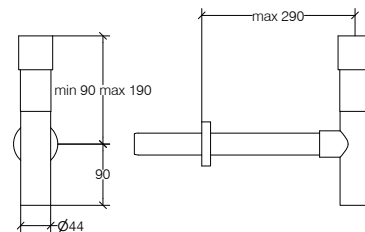

Ottone cromato
Chromed brass
Laiton chromé
Verchromtes Messing



5392

.29

€

101,00

Sifone salvaspazio, 1"-1/4 mm

Space saving siphon, 1"-1/4 mm / Siphon gain de place 1"1/4 mm / Siphon platzsparend 1" 1/4 mm

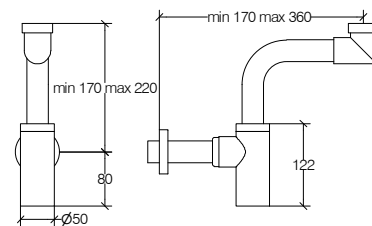

Ottone cromato
Chromed brass
Laiton chromé
Verchromtes Messing

Ottone verniciato
Painted brass
Laiton laqué
Lackiertem Messing



53921

.29

.23

€

125,00

131,00

Sifone 1"-1/4 mm

Siphon, 1"-1/4 mm / Siphon 1"1/4 mm / Siphon 1" 1/4 mm

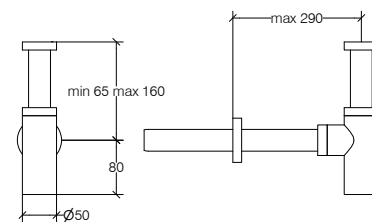

Ottone cromato
Chromed brass
Laiton chromé
Verchromtes Messing

Ottone verniciato
Painted brass
Laiton laqué
Lackiertem Messing



53922

.29

.23

€

75,00

98,00

BUSI E CANE

Sifone quadro 1"-1/4 mm

Square siphon, 1"- 1/4 mm / Siphon carré 1"1/4 mm / Siphon quadratisch 1" 1/4 mm

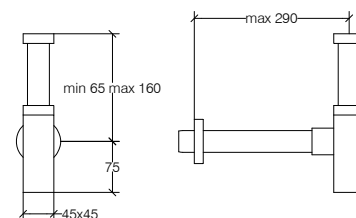

Ottone cromato
Chromed brass
Laiton chromé
Verchromtes Messing

**53925****.29**

€

87,00

Sifone per bidet, 1"-1/4 mm

Bidet siphon 1"- 1/4 mm / Siphon bidet 1" 1/4 mm / Bidet Siphon 1" 1/4 mm

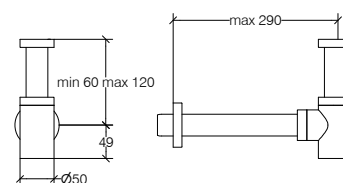

Ottone cromato
Chromed brass
Laiton chromé
Verchromtes Messing

Ottone verniciato
Painted brass
Laiton laqué
Lackiertem Messing

**53926****.29****.23**

€

66,00

87,00

Sifone salvaspazio, 1"-1/4 mm

Space saving siphon, 1"-1/4 mm / Siphon gain de place 1"1/4 mm / Siphon platzsparend 1" 1/4 mm

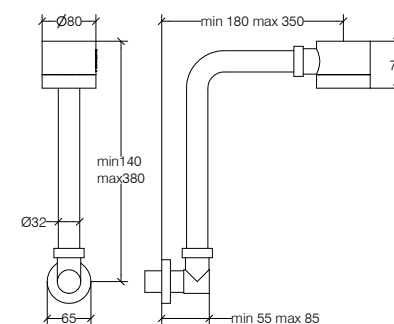

Ottone cromato
Chromed brass
Laiton chromé
Verchromtes Messing

**53927****.29**

€

119,00

BUSI E CANE

Ghiera appoggio vasche soprapiano

Support nut for washbasins/ Écrou de support pour vasques à poser / Aufsatzring für Waschbecken



Ottone cromato
Chromed brass
Laiton chromé
Verchromtes Messing



Oro opaco
Matt Gold
Or mat
Matt Gold



| | | |
|-------------|------------|------------|
| 5398 | .29 | .31 |
| € | 23,00 | 24,00 |

Piletta click regolabile 0-60 mm, 1" 1/4"

Automatic waste water drain adaptable 0-60 mm 1" 1/4" /
Bonde automatique réglable 0-60 mm 1" 1/4" / Druck-Ablaufgarnitur verstellbar 1" 1/4"

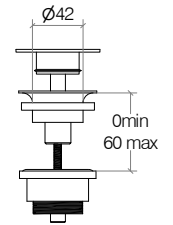

Ottone cromato
Chromed brass
Laiton chromé
Verchromtes Messing



Ottone verniciato
Painted brass
Laiton laqué
Lackiertem Messing



| | | |
|--------------|------------|------------|
| 53961 | .29 | .23 |
| € | 37,00 | 41,00 |

Piletta scarico libero, 1"- 1/4 mm

Free waste water drain, 1"- 1/4 mm / Bonde à écoulement libre / Freie Ablaufgarnitur 1" 1/4

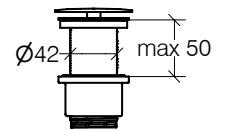

Ottone cromato
Chromed brass
Laiton chromé
Verchromtes Messing



| | |
|--------------|------------|
| 53972 | .29 |
| € | 36,00 |

Piletta scarico libero, 1"- 1/4 mm

Free waste water drain, 1"- 1/4 mm / Bonde à écoulement libre / Freie Ablaufgarnitur 1" 1/4

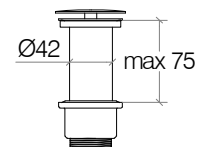

Ottone cromato
Chromed brass
Laiton chromé
Verchromtes Messing



| | |
|--------------|------------|
| 53975 | .29 |
| € | 38,00 |

BUSI E CANE

Piletta scarico libero regolabile

Adjustable free waste water drain / Bonde à écoulement libre ajustable / Einstellbarer Freie Ablaufgarnitur

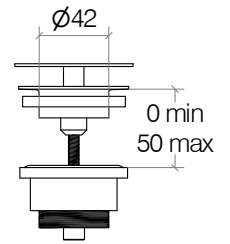

Ottone cromato
Chromed brass
Laiton chromé
Verchromtes Messing

Ottone verniciato
Painted brass
Laiton laqué
Lackiertem Messing

53976



.29



.23

€

38,00

41,00

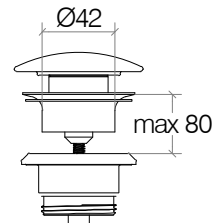
Piletta regolabile klik 0-80 mm con tappo in ceramicaAdjustable drain water drain 0-80 mm with ceramic cap / Bonde ajustable 0-80 mm avec bouchon en céramique
Einstellbarer Abfluss 0-80 mm mit Keramikplatte

Bianca lucida
Glossy white
Blanc brillant
Glänzend weiÙe

Antracite
Anthracite
Anthracite
Anthrazit

Bianca opaca
Matt white
Blanc mat
MattweiÙe

53977



.09



.17



.26

€

109,00

156,00

156,00

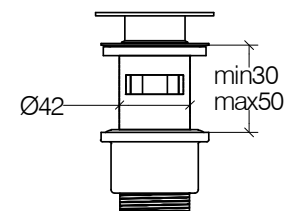
Piletta klik con troppieno max 50 mmAutomatic waste water drain with overflow max height 50 mm / Bonde automatique avec trop-plein max 50 mm
Druck-Ablaufgarnitur mit Überlauf max 50 mm

Ottone cromato
Chromed brass
Laiton chromé
Verchromtes Messing

Ottone verniciato
Painted brass
Laiton laqué
Lackiertem Messing

53991



.29



.23

€

38,00

41,00

BUSI E CANE

Piletta click con troppopieno

Waste water drain with overflow / Bonde avec trop-plein / Druck-Ablaufgarnitur mit Überlauf

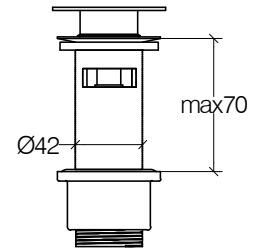

Ottone cromato
Chromed brass
Laiton chromé
Verchromtes Messing



53992

.29

€

41,00

Piletta click senza troppopieno

Waste water drain without overflow / Bonde sans trop-plein / Druck-Ablaufgarnitur ohne Überlauf

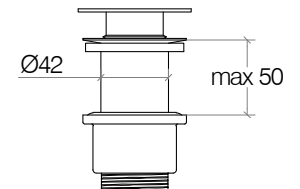

Ottone cromato
Chromed brass
Laiton chromé
Verchromtes Messing



53994

.29

€

37,00

Piletta click senza troppopieno

Waste water drain without overflow / Bonde sans trop-plein / Druck-Ablaufgarnitur ohne Überlauf

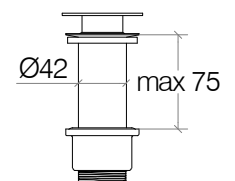

Ottone cromato
Chromed brass
Laiton chromé
Verchromtes Messing



53995

.29

€

40,00

BUSI E CANE

Preso acqua tonda con supporto doccia

Round water outlet with shower hook / Sortie d'eau ronde avec crochet pour douche /
Wandanschlussbogen rund mit Brausehalterung

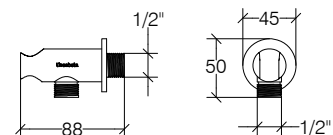

Ottone cromato
Chromed brass
Laiton chromé
Verchromtes Messing



54198

.29

€

46,00

Preso acqua quadra con supporto doccia

Square water outlet with shower hook / Sortie d'eau carrée avec crochet pour douche /
Wandanschlussbogen quadratisch mit Brausehalterung

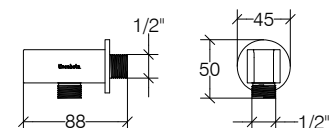

Ottone cromato
Chromed brass
Laiton chromé
Verchromtes Messing



54199

.29

€

51,00

Preso acqua tonda, uscita 1/2"

Round water outlet 1/2" / Sortie d'eau ronde, 1/2" / Wandanschlussbogen 1/2"

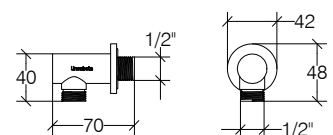

Ottone cromato
Chromed brass
Laiton chromé
Verchromtes Messing



54203

.29

€

26,00

BUSI E CANE

Preso acqua quadra, uscita 1/2"

Square water outlet 1/2" / Sortie d'eau carrée, 1/2" / Wandanschlussbogen quadratisch 1/2"

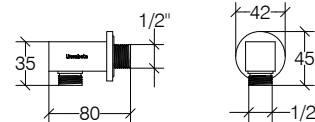

Ottone cromato
Chromed brass
Laiton chromé
Verchromtes Messing

**54204****.29**

€

28,00

Rubineto arresto tondo uscita 3/8

Concealed stop valve round with connection 3/8 / Robinet d'arrêt rond sortie 3/8 / Unterputzstopventil rund Anschluß 3/8

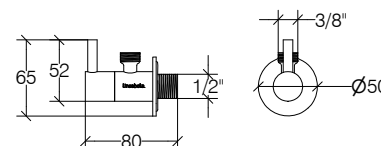

Ottone cromato
Chromed brass
Laiton chromé
Verchromtes Messing



Ottone verniciato
Painted brass
Laiton laqué
Lackiertem Messing

**54208****.29****.23**

€

34,00

38,00

Rubineto arresto quadro uscita 3/8

Concealed stop valve square 1/2" with connection 3/8 / Robinet d'arrêt carré 1/2" sortie 3/8 / Unterputzstopventil quadratisch 1/2" Anschluß 3/8

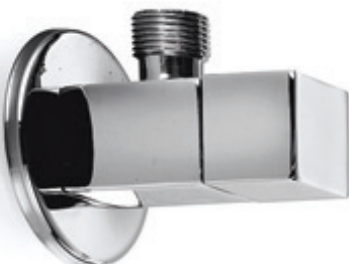
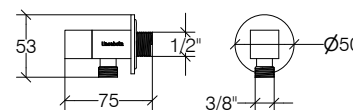

Ottone cromato
Chromed brass
Laiton chromé
Verchromtes Messing

**54209****.29**

€

38,00

CANOLE

Miscelatore monocomando lavabo

Single lever washbasin mixer / Mitigeur monotrou pour lavabo / Einhebel Mischer für Waschtisch

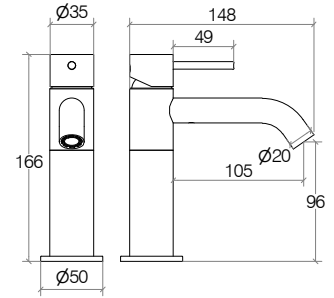

Acciaio inox lucido
Polished stainless steel
Acier inoxydable brillant
Poliert Edelstahl

Acciaio inox satinato
Satinated stainless steel
Acier inoxydable satiné
Vereist Edelstahl



| | | |
|-------------|------------|------------|
| 6302 | .29 | .32 |
| € | 336,00 | 308,00 |



AISI 316



Miscelatore monocomando lavabo alto

High single lever washbasin mixer / Mitigeur monotrou haut pour lavabo / Höher Einhebel Mischer für Waschtisch

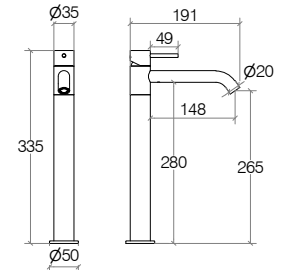

Acciaio inox lucido
Polished stainless steel
Acier inoxydable brillant
Poliert Edelstahl

Acciaio inox satinato
Satinated stainless steel
Acier inoxydable satiné
Vereist Edelstahl



| | | |
|-------------|------------|------------|
| 6304 | .29 | .32 |
| € | 430,00 | 390,00 |



AISI 316



Miscelatore monocomando bidet

Single lever bidet mixer / Mitigeur monotrou pour bidet / Einhebel Bidetmischer

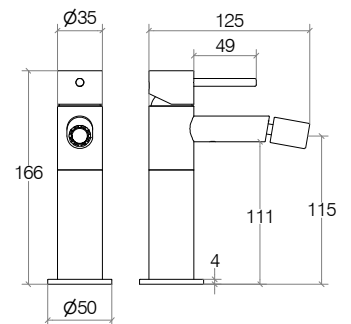

Acciaio inox lucido
Polished stainless steel
Acier inoxydable brillant
Poliert Edelstahl

Acciaio inox satinato
Satinated stainless steel
Acier inoxydable satiné
Vereist Edelstahl



| | | |
|-------------|------------|------------|
| 6206 | .29 | .32 |
| € | 350,00 | 322,00 |



AISI 316



CANOLE

Miscelatore incasso dev. 2 vie

Built-in mixer with diverter, 2 exits / Mitigeur à encastrer avec déviateur 2 sorties / Einhebel Mischer Unterputz mit 2 Umsteller

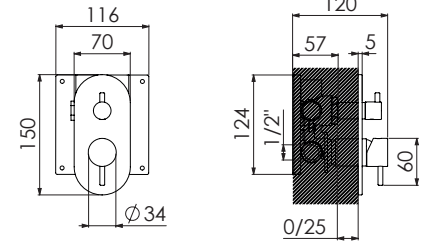

Acciaio inox lucido
Polished stainless steel
Acier inoxydable brillant
Poliert Edelstahl

Acciaio inox satinato
Satinated stainless steel
Acier inoxydable satiné
Vereist Edelstahl



6320

.29

.32

€

509,00

469,00



AISI 316



Miscelatore a muro 2 fori con canna

Built-in mixer with spout and 2 holes / Mitigeur à encastrer avec bec, 2 trous / Einhebel Mischer Unterputz mit Wanneneinlauf 2 Löcher

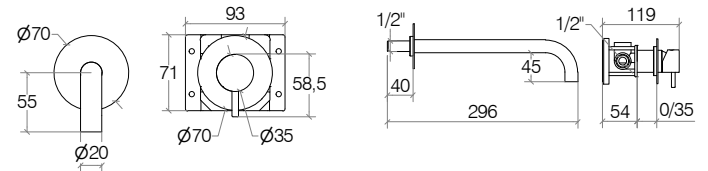

Acciaio inox lucido
Polished stainless steel
Acier inoxydable brillant
Poliert Edelstahl

Acciaio inox satinato
Satinated stainless steel
Acier inoxydable satiné
Vereist Edelstahl



6325

.29

.32

€

522,00

483,00



AISI 316



| | | | |
|--------------|-----------|---|-------|
| 5392 | R2553924 | Rosone a muro Ø 65 - Wall rosette Ø 65 | 8,00 |
| | R2553901 | Tubo uscita per sifone 400 mm - Exit tube for siphon 400 mm | 16,00 |
| | R2553902 | Tubo orlato entrata per sifoni 400 mm - Edged tube for siphon 400 mm | 16,00 |
| | R22539222 | Guarnizione D. 40 mm - Gasket D. 40 mm | 4,00 |
| 53921 | R25539212 | Tubo ad angolo - Corner tube | 16,00 |
| | R2553924 | Rosone a muro Ø 65 - Wall rosette Ø 65 | 8,00 |
| | R2553892 | Angolo ghiera girevole - Rotating grid angle | 29,00 |
| | R2553901 | Tubo uscita per sifone 400 mm - Exit tube for siphon 400 mm | 16,00 |
| 53922 | R2553924 | Rosone a muro Ø 65 - Wall rosette Ø 65 | 8,00 |
| | R2553901 | Tubo uscita per sifone 400 mm - Exit tube for siphon 400 mm | 16,00 |
| | R2553902 | Tubo orlato entrata per sifoni 400 mm - Edged tube for siphon 400 mm | 16,00 |
| | R22539221 | Bottiglia plastica interna sifone 53922 - Internal plastic bottle siph. 53922 | 7,00 |
| | R22539222 | Guarnizione D. 40 mm - Gasket D. 40 mm | 5,00 |
| | R25539223 | Ghiera superiore sifone 53922 - Upper grid for siphon 53922 | 14,00 |
| 53925 | R2553924 | Rosone a muro Ø 65 - Wall rosette Ø 65 | 8,00 |
| | R2553901 | Tubo uscita per sifone 400 mm - Exit tube for siphon 400 mm | 16,00 |
| | R2553902 | Tubo orlato entrata per sifoni 400 mm - Edged tube for siphon 400 mm | 16,00 |
| | R22539221 | Bottiglia plastica interna sifone 53922 - Internal plastic bottle siph. 53922 | 7,00 |
| | R22539222 | Guarnizione D. 40 mm - Gasket D. 40 mm | 5,00 |
| 53926 | R2553924 | Rosone a muro Ø 65 - Wall rosette Ø 65 | 8,00 |
| | R2553901 | Tubo uscita per sifone 400 mm - Exit tube for siphon 400 mm | 16,00 |
| | R2553902 | Tubo orlato entrata per sifoni 400 mm - Edged tube for siphon 400 mm | 16,00 |
| | R22539221 | Bottiglia plastica interna sifone 53922 - Internal plastic bottle siph. 53922 | 7,00 |
| | R22539222 | Guarnizione D. 40 mm - Gasket D. 40 mm | 5,00 |
| 53927 | R25539212 | Tubo ad angolo - Corner tube | 16,00 |
| | R2553924 | Rosone a muro Ø 65 - Wall rosette Ø 65 | 8,00 |
| | R25539271 | Gomito per sifone - Siphon angle pipe | 46,00 |
| | R25539272 | Bottiglia per sifone in ottone cromato 53927 - Siphon bottle in chromed brass 53927 | 8,00 |

Ricambi / Spare parts / Pièces détachées / Ersatzteile

| | | | |
|--------------|-------------|---|-------|
| 53961 | R25539612 | Tappo piletta - Waste water drain hole plug | 13,00 |
| | R25539611 | Meccanismo per piletta - Automatic waste water drain mechanism | 14,00 |
| | R2253971 | Guarnizione inferiore piletta gomma trasparente - Lower waste water drain transparent rubber o'ring | 6,00 |
| | R2253992 | Guarnizione tappo piletta click nera - Automatic waste water drain black o'ring | 6,00 |
| | R2253972 | Guarnizione superiore piletta in spugna - Upper waste water drain sponge o'ring | 6,00 |
| | R2453961222 | Tappo piletta nero - Black water drain cover | 15,00 |
| 53972 | R2553976 | Tappo piletta scarico libero Free waste water drain cover | 13,00 |
| | R2253971 | Guarnizione inferiore piletta gomma trasparente - Lower waste water drain transparent rubber o'ring | 6,00 |
| | R2253972 | Guarnizione superiore piletta in spugna Upper waste water drain sponge o'ring | 6,00 |
| 53975 | R2553976 | Tappo piletta scarico libero Free waste water drain cover | 13,00 |
| | R2253971 | Guarnizione inferiore piletta gomma trasparente - Lower waste water drain transparent rubber o'ring | 6,00 |
| | R2253972 | Guarnizione superiore piletta in spugna Upper waste water drain sponge o'ring | 6,00 |
| 53991 | R2553997 | Tappo piletta klik clak - Automatic waste water drain cover | 13,00 |
| | R2553998 | Meccanismo per piletta klik clak Automatic waste water drain mechanism | 14,00 |
| | R2253971 | Guarnizione inferiore piletta gomma trasparente - Lower waste water drain transparent rubber o'ring | 6,00 |
| | R2253972 | Guarnizione superiore piletta in spugna Upper waste water drain sponge o'ring | 6,00 |
| | R2253992 | Guarnizione tappo piletta click nera Automatic waste water drain black o'ring | 6,00 |
| | R245399722 | Tappo piletta nero - Black water drain cover | 14,00 |
| 53992 | R2553997 | Tappo piletta klik clak - Automatic waste water drain cover | 13,00 |
| | R2553998 | Meccanismo per piletta klik clak Automatic waste water drain mechanism | 14,00 |
| | R2253971 | Guarnizione inferiore piletta gomma trasparente - Lower waste water drain transparent rubber o'ring | 6,00 |
| | R2253972 | Guarnizione superiore piletta in spugna Upper waste water drain sponge o'ring | 6,00 |
| | R2253992 | Guarnizione tappo piletta click nera Automatic waste water drain black o'ring | 6,00 |
| 53994 | R2553997 | Tappo piletta klik clak - Automatic waste water drain cover | 13,00 |
| | R2553998 | Meccanismo per piletta klik clak - Automatic waste water drain mechanism | 14,00 |
| | R2253971 | Guarnizione inferiore piletta gomma trasparente - Lower waste water drain transparent rubber o'ring | 6,00 |
| | R2253972 | Guarnizione superiore piletta in spugna Upper waste water drain sponge o'ring | 6,00 |
| | R2253992 | Guarnizione tappo piletta click nera Automatic waste water drain black o'ring | 6,00 |

Ricambi / Spare parts / Pièces détachées / Ersatzteile

| | | | |
|--------------|-----------|---|-------|
| 53995 | R2553997 | Tappo piletta clik clak - Automatic waste water drain cover | 13,00 |
| | R2553998 | Meccanismo per piletta clik clak - Automatic waste water drain mechanism | 14,00 |
| | R2253971 | Guarnizione inferiore piletta gomma trasparente - Lower waste water drain transparent rubber o'ring | 6,00 |
| | R2253972 | Guarnizione superiore piletta in spugna - Upper waste water drain sponge o'ring | 6,00 |
| | R2253992 | Guarnizione tappo piletta click nera + Automatic waste water drain black o'ring | 6,00 |
| 54198 | R25542081 | Placca a muro tonda per rubinetto - Round faucet wall plate | 14,00 |
| 54199 | R25542081 | Placca a muro tonda per rubinetto - Round faucet wall plate | 14,00 |
| 54208 | R25542081 | Placca a muro tonda per rubinetto - Round faucet wall plate | 14,00 |
| 54203 | R25542081 | Placca a muro tonda per rubinetto - Round faucet wall plate | 14,00 |
| 54204 | R25542081 | Placca a muro tonda per rubinetto - Round faucet wall plate | 14,00 |
| 54209 | R25542081 | Placca a muro tonda per rubinetto - Round faucet wall plate | 14,00 |
| 6302 | R226202 | Cartuccia miscelatore - Mixer cartridge | 80,00 |
| | R2262021 | Aeratore per miscelatore - Mixer aerator | 8,00 |
| 6304 | R226202 | Cartuccia miscelatore - Mixer cartridge | 80,00 |
| | R2262021 | Aeratore per miscelatore - Mixer aerator | 8,00 |
| 6306 | R226202 | Cartuccia miscelatore - Mixer cartridge | 80,00 |
| | R2262021 | Aeratore per miscelatore - Mixer aerator | 8,00 |
| 6308 | R226202 | Cartuccia miscelatore - Mixer cartridge | 80,00 |
| | R2262021 | Aeratore per miscelatore - Mixer aerator | 8,00 |
| 6325 | R2262022 | Cartuccia miscelatore incasso e remoto D25 - Built-in and remote mixer cartridge D25 | 48,00 |

INDICE _ INDEX _ INDICE _ INDEX

| | | |
|------|-----|----------|
| 3901 | 150 | SAON |
| 3902 | 151 | SAON |
| 3903 | 151 | SAON |
| 3905 | 151 | SAON |
| 4412 | 148 | SAON |
| 4413 | 148 | SAON |
| 4414 | 148 | SAON |
| 5008 | 162 | BALENGHI |
| 5010 | 163 | BALENGHI |
| 5011 | 163 | BALENGHI |
| 5012 | 164 | BALENGHI |
| 5013 | 164 | BALENGHI |
| 5014 | 165 | BALENGHI |
| 5015 | 165 | BALENGHI |
| 5021 | 160 | BASTON |
| 5022 | 160 | BASTON |
| 5023 | 161 | BASTON |
| 5024 | 161 | BASTON |
| 5111 | 172 | STELA |
| 5112 | 173 | STELA |
| 5113 | 175 | RANPIN |
| 5114 | 175 | RANPIN |
| 5115 | 176 | RANPIN |
| 5116 | 49 | GRELA |
| 5117 | 49 | GRELA |
| 5118 | 170 | GRELA |
| 5120 | 178 | RANPIN |
| 5121 | 176 | BAKETO |
| 5124 | 177 | RANPIN |
| 5126 | 179 | RANPIN |
| 5130 | 171 | POSA' |
| 5135 | 66 | SAETA |
| 5146 | 47 | GRELA |
| 5146 | 62 | ROERSA |
| 5146 | 68 | SAETA |
| 5146 | 48 | GRELA |
| 5147 | 48 | GRELA |
| 5147 | 62 | ROERSA |
| 5147 | 69 | SAETA |
| 5148 | 62 | GRELA |
| 5148 | 62 | ROERSA |
| 5148 | 69 | SAETA |
| 5152 | 47 | GRELA |
| 5152 | 62 | ROERSA |
| 5152 | 68 | SAETA |
| 5153 | 48 | GRELA |
| 5153 | 63 | ROERSA |
| 5153 | 69 | SAETA |
| 5160 | 60 | ROERSA |
| 5161 | 60 | ROERSA |
| 5164 | 60 | ROERSA |
| 5165 | 60 | ROERSA |

| | | |
|------|-----------|-------------|
| 5169 | 61 | ROERSA |
| 5170 | 61 | ROERSA |
| 5171 | 61 | ROERSA |
| 5172 | 61 | ROERSA |
| 5200 | 88 | BAKETO |
| 5200 | 107 | DUEMILA |
| 5200 | 123 | PICOLA |
| 5200 | 150 | SAON |
| 5226 | 182 | RANPIN |
| 5229 | 182 | RANPIN |
| 5254 | 120 | PICOLA |
| 5255 | 120 | PICOLA |
| 5258 | 120 | PICOLA |
| 5259 | 122 | PICOLA |
| 5260 | 121 | PICOLA |
| 5262 | 121 | PICOLA |
| 5264 | 121 | PICOLA |
| 5265 | 121 | PICOLA |
| 5273 | 125 | PICOLA |
| 5276 | 91 | BAKETO |
| 5276 | 100 | NAPIE |
| 5276 | 109 | DUEMILA |
| 5276 | 125 | PICOLA |
| 5276 | 132 | VENESSIA |
| 5277 | 91 | BAKETO |
| 5277 | 100 | NAPIE |
| 5277 | 109 | DUEMILA |
| 5277 | 125 | PICOLA |
| 5277 | 132 | VENESSIA |
| 5278 | 91 | BAKETO |
| 5278 | 100 | NAPIE |
| 5278 | 109 | DUEMILA |
| 5278 | 125 | PICOLA |
| 5278 | 132 | VENESSIA |
| 5279 | 91 | BAKETO |
| 5279 | 100 | NAPIE |
| 5279 | 109 | DUEMILA |
| 5279 | 125 | PICOLA |
| 5279 | 132 | VENESSIA |
| 5344 | 189 | SESTEI |
| 5345 | 190 | SESTEI |
| 5347 | 190 | SESTEI |
| 5354 | 191 | SESTEI |
| 5355 | 191 | SESTEI |
| 5392 | 390 | BUSI E CANE |
| 5398 | 392 | BUSI E CANE |
| 5430 | 342 | RUNNER |
| 5431 | 342 | RUNNER |
| 5435 | 343 | RUNNER |
| 5436 | 343 | RUNNER |
| 5438 | 344 | RUNNER |
| 5442 | 342 - 343 | RUNNER |

| | | |
|------|-----------|-------------|
| 5443 | 343 - 344 | RUNNER |
| 5450 | 345 | CARETO |
| 5504 | 104 | DUEMILA |
| 5505 | 104 | DUEMILA |
| 5507 | 104 | DUEMILA |
| 5508 | 104 | DUEMILA |
| 5509 | 106 | DUEMILA |
| 5511 | 105 | DUEMILA |
| 5512 | 105 | DUEMILA |
| 5513 | 105 | DUEMILA |
| 5514 | 105 | DUEMILA |
| 5517 | 106 | DUEMILA |
| 5526 | 109 | DUEMILA |
| 5588 | 263 | MEVEDO |
| 5591 | 263 | MEVEDO |
| 5593 | 265 | MEVEDO |
| 5594 | 266 | MEVEDO |
| 5595 | 264 | MEVEDO |
| 5596 | 264 | MEVEDO |
| 5671 | 284 | SPECI |
| 5689 | 285 | SPECI |
| 5720 | 293 | CIARI |
| 5721 | 293 | CIARI |
| 5723 | 294 | CIARI |
| 5729 | 294 | CIARI |
| 5730 | 295 | CIARI |
| 5731 | 295 | CIARI |
| 5732 | 294 | CIARI |
| 5733 | 293 | CIARI |
| 5734 | 293 | CIARI |
| 6206 | 397 | BUSI E CANE |
| 6302 | 397 | BUSI E CANE |
| 6304 | 397 | BUSI E CANE |
| 6320 | 398 | CANOLE |
| 6325 | 398 | CANOLE |
| 6622 | 361 | CIUCI |
| 6663 | 369 | CADIN |
| 7218 | 319 | GRELA |
| 7224 | 227 | ATLANTICA |
| 7225 | 227 | ATLANTICA |
| 7226 | 227 | ATLANTICA |
| 7227 | 227 | ATLANTICA |
| 7228 | 227 | ATLANTICA |
| 7229 | 227 | ATLANTICA |
| 7230 | 227 | ATLANTICA |
| 7509 | 383 | CALIGO |
| 7510 | 385 | CALIGO |
| 7511 | 384 | CALIGO |
| 7512 | 384 | CALIGO |
| 7513 | 384 | CALIGO |
| 7514 | 384 | CALIGO |
| 7515 | 385 | CALIGO |

| | | |
|-------|-----|---------|
| 7516 | 385 | CALIGO |
| 7517 | 386 | CALIGO |
| 8040 | 330 | CIACOLE |
| 8051 | 338 | CIACOLE |
| 8052 | 332 | CIACOLE |
| 8059 | 331 | CIACOLE |
| 8220 | 318 | GRELA |
| 8221 | 319 | GRELA |
| 8240 | 316 | GRELA |
| 8241 | 317 | GRELA |
| 8242 | 317 | GRELA |
| 8260 | 314 | GRELA |
| 8261 | 315 | GRELA |
| 8262 | 315 | GRELA |
| 8280 | 310 | GRELA |
| 8281 | 311 | GRELA |
| 8282 | 313 | GRELA |
| 8293 | 336 | PIKÀ |
| 44018 | 147 | SAON |
| 44021 | 144 | SAON |
| 44022 | 144 | SAON |
| 44023 | 144 | SAON |
| 44024 | 145 | SAON |
| 44025 | 145 | SAON |
| 44031 | 145 | SAON |
| 44032 | 146 | SAON |
| 44033 | 146 | SAON |
| 44034 | 146 | SAON |
| 44041 | 147 | SAON |
| 44070 | 152 | NAPIE |
| 44281 | 255 | OTHELLO |
| 50002 | 236 | FILO |
| 50003 | 236 | FILO |
| 50004 | 235 | FILO |
| 50011 | 237 | FILO |
| 50012 | 237 | FILO |
| 50013 | 237 | FILO |
| 50021 | 238 | FILO |
| 50022 | 238 | FILO |
| 50024 | 236 | FILO |
| 50028 | 230 | FILO |
| 50030 | 230 | FILO |
| 50031 | 231 | FILO |
| 50032 | 232 | FILO |
| 50033 | 232 | FILO |
| 50034 | 234 | FILO |
| 50035 | 234 | FILO |
| 50036 | 233 | FILO |
| 50037 | 233 | FILO |
| 50039 | 235 | FILO |
| 50040 | 235 | FILO |
| 50048 | 63 | ROERSA |

| | | |
|-------|-----|---------|
| 50048 | 70 | SAETA |
| 50048 | 90 | BAKETO |
| 50048 | 99 | NAPIE |
| 50048 | 109 | DUEMILA |
| 50048 | 117 | SBECA |
| 50048 | 124 | PICOLA |
| 50048 | 159 | SKOATI |
| 50056 | 49 | GRELA |
| 50056 | 57 | DADO |
| 50056 | 80 | SKUARA |
| 50056 | 158 | SKOATI |
| 50203 | 158 | SKOATI |
| 50207 | 162 | SKOATI |
| 51111 | 172 | STELA |
| 51121 | 173 | STELA |
| 51191 | 178 | RANPIN |
| 51192 | 181 | RANPIN |
| 51193 | 177 | RANPIN |
| 51194 | 180 | RANPIN |
| 51195 | 179 | RANPIN |
| 51239 | 181 | RANPIN |
| 51259 | 180 | RANPIN |
| 51502 | 339 | PIKÀ |
| 51504 | 333 | PIKÀ |
| 51505 | 334 | PIKÀ |
| 51506 | 335 | PIKÀ |
| 51511 | 339 | PIKÀ |
| 51701 | 44 | GRELA |
| 51702 | 44 | GRELA |
| 51703 | 45 | GRELA |
| 51705 | 45 | GRELA |
| 51706 | 46 | GRELA |
| 51708 | 46 | GRELA |
| 51709 | 46 | GRELA |
| 51721 | 44 | GRELA |
| 51723 | 45 | GRELA |
| 51725 | 47 | GRELA |
| 51811 | 66 | SAETA |
| 51813 | 66 | SAETA |
| 51815 | 67 | SAETA |
| 51816 | 67 | SAETA |
| 51817 | 67 | SAETA |
| 51818 | 67 | SAETA |
| 51819 | 68 | SAETA |
| 51820 | 69 | SAETA |
| 51821 | 66 | SAETA |
| 51822 | 70 | SAETA |
| 52241 | 183 | RANPIN |
| 52271 | 182 | RANPIN |
| 52510 | 123 | PICOLA |
| 52511 | 122 | PICOLA |
| 52535 | 120 | PICOLA |

| | | |
|-------|-----|----------|
| 52561 | 123 | PICOLA |
| 52801 | 77 | SKUARA |
| 52802 | 77 | SKUARA |
| 52803 | 78 | SKUARA |
| 52804 | 79 | SKUARA |
| 52805 | 79 | SKUARA |
| 52806 | 74 | SKUARA |
| 52807 | 74 | SKUARA |
| 52808 | 76 | SKUARA |
| 52810 | 76 | SKUARA |
| 52811 | 76 | SKUARA |
| 52812 | 77 | SKUARA |
| 52813 | 75 | SKUARA |
| 52814 | 75 | SKUARA |
| 52815 | 75 | SKUARA |
| 52816 | 75 | SKUARA |
| 52818 | 76 | SKUARA |
| 52834 | 80 | SKUARA |
| 52836 | 81 | SKUARA |
| 52843 | 81 | SKUARA |
| 52844 | 81 | SKUARA |
| 52853 | 74 | SKUARA |
| 52867 | 74 | SKUARA |
| 52901 | 130 | VENESSIA |
| 52904 | 131 | VENESSIA |
| 52906 | 131 | VENESSIA |
| 52907 | 128 | VENESSIA |
| 52908 | 128 | VENESSIA |
| 52910 | 128 | VENESSIA |
| 52914 | 129 | VENESSIA |
| 52916 | 129 | VENESSIA |
| 52917 | 130 | VENESSIA |
| 52920 | 130 | VENESSIA |
| 52921 | 130 | VENESSIA |
| 52924 | 132 | VENESSIA |
| 52926 | 129 | VENESSIA |
| 52932 | 132 | VENESSIA |
| 52938 | 128 | VENESSIA |
| 52939 | 129 | VENESSIA |
| 53020 | 98 | NAPIE |
| 53020 | 152 | SAON |
| 53021 | 98 | NAPIE |
| 53021 | 152 | SAON |
| 53022 | 98 | NAPIE |
| 53022 | 153 | SAON |
| 53101 | 245 | OTHELLO |
| 53102 | 246 | OTHELLO |
| 53103 | 246 | OTHELLO |
| 53104 | 244 | OTHELLO |
| 53105 | 244 | OTHELLO |
| 53106 | 245 | OTHELLO |
| 53120 | 95 | NAPIE |

INDICE _ INDEX _ INDICE _ INDEX

| | | |
|-------|-----|---------|
| 53121 | 96 | NAPIE |
| 53122 | 96 | NAPIE |
| 53123 | 96 | NAPIE |
| 53130 | 96 | NAPIE |
| 53131 | 97 | NAPIE |
| 53133 | 97 | NAPIE |
| 53134 | 97 | NAPIE |
| 53135 | 95 | NAPIE |
| 53136 | 95 | NAPIE |
| 53137 | 95 | NAPIE |
| 53138 | 94 | NAPIE |
| 53140 | 94 | NAPIE |
| 53142 | 101 | NAPIE |
| 53143 | 101 | NAPIE |
| 53144 | 100 | NAPIE |
| 53145 | 98 | NAPIE |
| 53146 | 99 | NAPIE |
| 53160 | 247 | OTHELLO |
| 53264 | 248 | OTHELLO |
| 53266 | 249 | OTHELLO |
| 53267 | 251 | OTHELLO |
| 53269 | 251 | OTHELLO |
| 53270 | 254 | OTHELLO |
| 53271 | 255 | OTHELLO |
| 53272 | 252 | OTHELLO |
| 53273 | 250 | OTHELLO |
| 53274 | 255 | OTHELLO |
| 53276 | 250 | OTHELLO |
| 53277 | 253 | OTHELLO |
| 53288 | 223 | DOCCIA |
| 53289 | 223 | DOCCIA |
| 53290 | 223 | DOCCIA |
| 53292 | 253 | OTHELLO |
| 53293 | 252 | OTHELLO |
| 53294 | 254 | OTHELLO |
| 53295 | 251 | OTHELLO |
| 53297 | 189 | SESTEI |
| 53298 | 189 | SESTEI |
| 53443 | 188 | BANDONI |
| 53444 | 188 | BANDONI |
| 53553 | 352 | MOMON |
| 53559 | 368 | MOMON |
| 53560 | 368 | MOMON |
| 53563 | 352 | MOMON |
| 53564 | 352 | MOMON |
| 53564 | 369 | CADIN |
| 53565 | 366 | FÒRA |
| 53570 | 318 | GRELA |
| 53571 | 317 | GRELA |
| 53572 | 315 | GRELA |
| 53573 | 312 | GRELA |
| 53574 | 317 | GRELA |

| | | |
|-------|-----|-------------|
| 53575 | 315 | GRELA |
| 53576 | 312 | GRELA |
| 53586 | 355 | ACQUAIO |
| 53593 | 372 | ACQUAIO |
| 53596 | 355 | ACQUAIO |
| 53663 | 372 | ACQUAIO |
| 53666 | 355 | ACQUAIO |
| 53694 | 354 | ACQUAIO |
| 53703 | 357 | QUARELO |
| 53708 | 358 | QUARELO |
| 53708 | 362 | QUARELO |
| 53709 | 357 | QUARELO |
| 53709 | 363 | QUARELO |
| 53710 | 356 | QUARELO |
| 53710 | 363 | QUARELO |
| 53801 | 216 | SUPIONI |
| 53802 | 216 | SUPIONI |
| 53804 | 217 | SUPIONI |
| 53806 | 217 | SUPIONI |
| 53807 | 217 | SUPIONI |
| 53808 | 217 | SUPIONI |
| 53810 | 212 | SUPIONI |
| 53811 | 212 | SUPIONI |
| 53812 | 212 | SUPIONI |
| 53815 | 212 | SUPIONI |
| 53816 | 212 | SUPIONI |
| 53817 | 212 | SUPIONI |
| 53834 | 213 | SUPIONI |
| 53835 | 213 | SUPIONI |
| 53836 | 213 | SUPIONI |
| 53839 | 214 | SUPIONI |
| 53840 | 213 | SUPIONI |
| 53841 | 213 | SUPIONI |
| 53842 | 213 | SUPIONI |
| 53860 | 214 | SUPIONI |
| 53861 | 214 | SUPIONI |
| 53870 | 215 | SUPIONI |
| 53871 | 215 | SUPIONI |
| 53872 | 215 | SUPIONI |
| 53880 | 215 | SUPIONI |
| 53881 | 215 | SUPIONI |
| 53882 | 215 | SUPIONI |
| 53883 | 210 | SUPIONI |
| 53884 | 210 | SUPIONI |
| 53885 | 211 | SUPIONI |
| 53886 | 211 | SUPIONI |
| 53887 | 209 | SUPIONI |
| 53915 | 208 | SUPIONI |
| 53921 | 390 | BUSI E CANE |
| 53922 | 390 | BUSI E CANE |
| 53925 | 391 | BUSI E CANE |
| 53926 | 391 | BUSI E CANE |

| | | |
|-------|-----|-------------|
| 53927 | 391 | BUSI E CANE |
| 53961 | 392 | BUSI E CANE |
| 53972 | 392 | BUSI E CANE |
| 53975 | 392 | BUSI E CANE |
| 53976 | 393 | BUSI E CANE |
| 53977 | 393 | BUSI E CANE |
| 53991 | 393 | BUSI E CANE |
| 53992 | 394 | BUSI E CANE |
| 53994 | 394 | BUSI E CANE |
| 53995 | 394 | BUSI E CANE |
| 54174 | 222 | DOCCIA |
| 54175 | 222 | DOCCIA |
| 54180 | 221 | DOCCIA |
| 54190 | 206 | SUPIONI |
| 54192 | 238 | RÈNTO |
| 54198 | 395 | BUSI E CANE |
| 54199 | 395 | BUSI E CANE |
| 54203 | 395 | BUSI E CANE |
| 54204 | 396 | BUSI E CANE |
| 54208 | 396 | BUSI E CANE |
| 54209 | 396 | BUSI E CANE |
| 54703 | 194 | SCAGNI |
| 54720 | 194 | SCAGNI |
| 54722 | 194 | SCAGNI |
| 55001 | 106 | DUEMILA |
| 55002 | 106 | DUEMILA |
| 55003 | 88 | BAKETO |
| 55003 | 107 | DUEMILA |
| 55003 | 122 | PICOLA |
| 55003 | 149 | SAON |
| 55004 | 88 | BAKETO |
| 55004 | 107 | DUEMILA |
| 55004 | 122 | PICOLA |
| 55004 | 149 | SAON |
| 55006 | 88 | BAKETO |
| 55006 | 107 | DUEMILA |
| 55006 | 123 | PICOLA |
| 55006 | 150 | SAON |
| 55032 | 108 | DUEMILA |
| 55061 | 108 | DUEMILA |
| 55062 | 90 | BAKETO |
| 55062 | 99 | NAPIE |
| 55062 | 108 | DUEMILA |
| 55062 | 124 | PICOLA |
| 55761 | 247 | OTHELLO |
| 55851 | 265 | MEVEDO |
| 55853 | 263 | MEVEDO |
| 55862 | 262 | MEVEDO |
| 55864 | 266 | MEVEDO |
| 55865 | 262 | MEVEDO |
| 55943 | 265 | MEVEDO |
| 55963 | 264 | MEVEDO |

| | | |
|--------------|-----|--------------|
| | | |
| 56300 | 287 | SPECI |
| 56301 | 287 | SPECI |
| 56302 | 288 | SPECI |
| 56303 | 288 | SPECI |
| 56304 | 288 | SPECI |
| 56305 | 288 | SPECI |
| 56306 | 288 | SPECI |
| 56307 | 288 | SPECI |
| 56308 | 289 | SPECI |
| 56309 | 289 | SPECI |
| 56310 | 289 | SPECI |
| 56311 | 289 | SPECI |
| 56312 | 289 | SPECI |
| 56313 | 289 | SPECI |
| 56314 | 289 | SPECI |
| 56315 | 289 | SPECI |
| 56683 | 290 | SPECI |
| 56685 | 291 | SPECI |
| 56707 | 285 | SPECI |
| 56708 | 285 | SPECI |
| 56709 | 285 | SPECI |
| 56710 | 285 | SPECI |
| 56761 | 286 | SPECI |
| 56762 | 286 | SPECI |
| 56851 | 284 | SPECI |
| 58100 | 278 | SPECI |
| 58102 | 279 | SPECI |
| 58103 | 279 | SPECI |
| 58104 | 278 | SPECI |
| 58106 | 279 | SPECI |
| 58107 | 279 | SPECI |
| 58108 | 278 | SPECI |
| 58110 | 279 | SPECI |
| 58111 | 279 | SPECI |
| 58112 | 278 | SPECI |
| 58114 | 279 | SPECI |
| 58115 | 279 | SPECI |
| 58116 | 278 | SPECI |
| 58118 | 279 | SPECI |
| 58119 | 279 | SPECI |
| 58120 | 278 | SPECI |
| 58122 | 279 | SPECI |
| 58123 | 279 | SPECI |
| 58124 | 278 | SPECI |
| 58126 | 279 | SPECI |
| 58127 | 279 | SPECI |
| 58128 | 278 | SPECI |
| 58130 | 279 | SPECI |
| 58131 | 279 | SPECI |
| 58132 | 278 | SPECI |
| 58134 | 279 | SPECI |
| 58135 | 279 | SPECI |

| | | |
|--------------|-----|--------------|
| | | |
| 58200 | 280 | SPECI |
| 58202 | 281 | SPECI |
| 58203 | 281 | SPECI |
| 58204 | 280 | SPECI |
| 58206 | 281 | SPECI |
| 58207 | 281 | SPECI |
| 58208 | 281 | SPECI |
| 58210 | 281 | SPECI |
| 58211 | 281 | SPECI |
| 58212 | 280 | SPECI |
| 58214 | 281 | SPECI |
| 58215 | 281 | SPECI |
| 58216 | 280 | SPECI |
| 58218 | 281 | SPECI |
| 58219 | 281 | SPECI |
| 58220 | 280 | SPECI |
| 58222 | 281 | SPECI |
| 58223 | 281 | SPECI |
| 58224 | 280 | SPECI |
| 58226 | 281 | SPECI |
| 58227 | 281 | SPECI |
| 58228 | 280 | SPECI |
| 58230 | 281 | SPECI |
| 58231 | 281 | SPECI |
| 58232 | 280 | SPECI |
| 58234 | 281 | SPECI |
| 58235 | 281 | SPECI |
| 58300 | 282 | SPECI |
| 58302 | 283 | SPECI |
| 58303 | 283 | SPECI |
| 58304 | 282 | SPECI |
| 58306 | 283 | SPECI |
| 58307 | 283 | SPECI |
| 58308 | 282 | SPECI |
| 58310 | 283 | SPECI |
| 58311 | 283 | SPECI |
| 58312 | 282 | SPECI |
| 58314 | 283 | SPECI |
| 58315 | 283 | SPECI |
| 58316 | 282 | SPECI |
| 58318 | 283 | SPECI |
| 58319 | 282 | SPECI |
| 58320 | 282 | SPECI |
| 58322 | 283 | SPECI |
| 58323 | 283 | SPECI |
| 58324 | 282 | SPECI |
| 58326 | 283 | SPECI |
| 58327 | 283 | SPECI |
| 58328 | 282 | SPECI |
| 58330 | 283 | SPECI |
| 58331 | 283 | SPECI |
| 58332 | 282 | SPECI |

| | | |
|--------------|-----|---------------|
| | | |
| 58334 | 283 | SPECI |
| 58335 | 283 | SPECI |
| 58400 | 275 | SPECI |
| 58402 | 276 | SPECI |
| 58404 | 277 | SPECI |
| 58405 | 277 | SPECI |
| 58406 | 275 | SPECI |
| 58408 | 276 | SPECI |
| 58410 | 277 | SPECI |
| 58411 | 277 | SPECI |
| 58412 | 275 | SPECI |
| 58414 | 276 | SPECI |
| 58416 | 277 | SPECI |
| 58417 | 277 | SPECI |
| 58418 | 275 | SPECI |
| 58420 | 276 | SPECI |
| 58422 | 277 | SPECI |
| 58423 | 277 | SPECI |
| 58424 | 275 | SPECI |
| 58426 | 276 | SPECI |
| 58428 | 277 | SPECI |
| 58429 | 277 | SPECI |
| 58430 | 275 | SPECI |
| 58432 | 276 | SPECI |
| 58434 | 277 | SPECI |
| 58435 | 277 | SPECI |
| 58436 | 275 | SPECI |
| 58438 | 276 | SPECI |
| 58440 | 277 | SPECI |
| 58441 | 277 | SPECI |
| 58442 | 275 | SPECI |
| 58444 | 276 | SPECI |
| 58446 | 277 | SPECI |
| 58447 | 277 | SPECI |
| 58448 | 275 | SPECI |
| 58450 | 276 | SPECI |
| 58452 | 277 | SPECI |
| 58453 | 277 | SPECI |
| 61101 | 116 | SBECA' |
| 61102 | 116 | SBECA' |
| 61103 | 116 | SBECA' |
| 61104 | 114 | SBECA' |
| 61105 | 114 | SBECA' |
| 61107 | 114 | SBECA' |
| 61108 | 114 | SBECA' |
| 61109 | 115 | SBECA' |
| 61110 | 115 | SBECA' |
| 61111 | 115 | SBECA' |
| 61115 | 115 | SBECA' |
| 61201 | 55 | DADO |
| 61202 | 55 | DADO |
| 61203 | 55 | DADO |

INDICE _ INDEX _ INDICE _ INDEX

| | | |
|--------|-----|-----------|
| 61204 | 52 | DADO |
| 61205 | 52 | DADO |
| 61206 | 52 | DADO |
| 61207 | 53 | DADO |
| 61208 | 53 | DADO |
| 61209 | 53 | DADO |
| 61210 | 53 | DADO |
| 61211 | 54 | DADO |
| 61212 | 54 | DADO |
| 61213 | 54 | DADO |
| 61214 | 54 | DADO |
| 61215 | 55 | DADO |
| 61216 | 56 | DADO |
| 61221 | 56 | DADO |
| 61222 | 56 | DADO |
| 61223 | 56 | DADO |
| 66213 | 326 | GOTO |
| 66631 | 369 | CADIN |
| 71801 | 226 | DOCCIA |
| 71804 | 226 | DOCCIA |
| 71805 | 226 | DOCCIA |
| 72271 | 227 | ATLANTICA |
| 75011 | 380 | CALIGO |
| 75021 | 381 | CALIGO |
| 75031 | 382 | CALIGO |
| 75041 | 378 | CALIGO |
| 75051 | 379 | CALIGO |
| 75092 | 383 | CALIGO |
| 75093 | 383 | CALIGO |
| 81107 | 322 | CANAVERA |
| 81110 | 322 | CANAVERA |
| 81113 | 323 | CANAVERA |
| 81119 | 324 | CANAVERA |
| 81120 | 323 | CANAVERA |
| 81120 | 193 | SCAGNI |
| 81140 | 325 | CANAVERA |
| 81141 | 324 | CANAVERA |
| 82401 | 316 | GRELA |
| 82601 | 314 | GRELA |
| 82801 | 310 | GRELA |
| 82802 | 310 | GRELA |
| 82803 | 310 | GRELA |
| 82901 | 337 | GRELA |
| 82911 | 338 | GRELA |
| 82941 | 320 | DE SORA |
| 82942 | 320 | DE SORA |
| 82943 | 320 | DE SORA |
| 528041 | 149 | SAON |
| 532621 | 248 | OTHELLO |
| 535732 | 312 | GRELA |
| 535762 | 312 | GRELA |
| 536981 | 356 | ACQUAIO |

| | | |
|-----------|-----------|---------|
| 536982 | 353 | ACQUAIO |
| 536983 | 353 | ACQUAIO |
| 536984 | 354 | ACQUAIO |
| 536985 | 353 | ACQUAIO |
| 536986 | 354 | ACQUAIO |
| 536991 | 356 | ACQUAIO |
| 537081 | 358 - 362 | QUARELO |
| 537091 | 363 | QUARELO |
| 541701 | 220 | DOCCIA |
| 541702 | 220 | DOCCIA |
| 541712 | 219 | DOCCIA |
| 541713 | 219 | DOCCIA |
| 541714 | 220 | DOCCIA |
| 541721 | 219 | DOCCIA |
| 541723 | 218 | DOCCIA |
| 541725 | 218 | DOCCIA |
| 541726 | 218 | DOCCIA |
| 50029DX | 231 | FILO |
| 50029SX | 231 | FILO |
| 51819DX | 68 | SAETA |
| 51819DX | 68 | SAETA |
| 52804.09 | 78 | SKUARA |
| 52804.09 | 78 | SKUARA |
| 52805.09 | 79 | SKUARA |
| 52805.09 | 79 | SKUARA |
| 53139D | 94 | NAPIE |
| 53139S | 94 | NAPIE |
| 5351.29 | 191 | SESTEI |
| 53573DX | 312 | GRELA |
| 53573SX | 312 | GRELA |
| 53706.29 | 357 - 361 | QUARELO |
| 537061.29 | 358 - 362 | QUARELO |
| 53802R | 216 | SUPIONI |
| 53802R | 216 | SUPIONI |
| 53807R | 216 | SUPIONI |
| 53830.09 | 201 | ISTÀ |
| 54191.09 | 207 | SUPIONI |
| 54300.80 | 202 | TOKI |
| 54301.80 | 202 | TOKI |
| 54302.80 | 202 | TOKI |
| 54304.80 | 202 | TOKI |
| 54306.80 | 202 | TOKI |
| 54310.80 | 203 | TOKI |
| 54311.80 | 203 | TOKI |
| 54312.80 | 203 | TOKI |
| 54314.80 | 203 | TOKI |
| 54316.80 | 203 | TOKI |
| 54318.80 | 203 | TOKI |
| 665801.29 | 361 | POCIA |
| 82801DX | 310 | GRELA |
| 82801SX | 310 | GRELA |
| 8280DX | 310 | GRELA |

| | | |
|------------------|-----|---------|
| 8280SX | 310 | GRELA |
| 8290dx | 337 | GRELA |
| 8290Sx | 337 | GRELA |
| 8291DX | 338 | GRELA |
| 8291SX | 338 | GRELA |
| 82951DX | 321 | DE SORA |
| 82951SX | 321 | DE SORA |
| 82952DX | 321 | DE SORA |
| 82952SX | 321 | DE SORA |
| 82953DX | 321 | DE SORA |
| 82953SX | 321 | DE SORA |
| A53565K1 | 367 | FÒRA |
| A53565K2 | 367 | FÒRA |
| R612K | 52 | DADO |
| S1210010 | 274 | SPECI |
| S1210020 | 274 | SPECI |
| S1210025 | 274 | SPECI |
| S1210030 | 274 | SPECI |
| S1210040 | 274 | SPECI |
| S1210050 | 274 | SPECI |
| S1326210 | 286 | SPECI |
| S1326220 | 286 | SPECI |
| S1326230 | 286 | SPECI |
| S1920110 | 272 | SPECI |
| S1920120 | 272 | SPECI |
| S1920125 | 272 | SPECI |
| S1920130 | 272 | SPECI |
| S1920140 | 272 | SPECI |
| S1920150 | 272 | SPECI |
| S1921310 | 273 | SPECI |
| S1921320 | 273 | SPECI |
| S1921325 | 273 | SPECI |
| S1921330 | 273 | SPECI |
| S1921340 | 273 | SPECI |
| S1921350 | 273 | SPECI |
| TA-BAKETOFIX | 91 | BAKETO |
| TA-DOCCIA0 | 224 | DOCCIA |
| TA-DOCCIA0MAXII | 225 | DOCCIA |
| TA-DOCCIAT | 224 | DOCCIA |
| TA-DOCCIATMAXI2 | 225 | DOCCIA |
| TA-DUEMILAFIX | 110 | DUEMILA |
| TA-DUEMILAFIXBIS | 110 | DUEMILA |
| TA-PICOLAFIXBIS | 125 | PICOLA |

CONDIZIONI GENERALI DI TRASPORTO E VENDITA

ITALIA

- 1) I prezzi del listino sono espressi in euro, IVA esclusa, non sono impegnativi e si intendono per merce resa franco stabilimento Italia.
- 2) Qualora la merce per consegne Italia venisse spedita franco destino sarà calcolato un addebito in fattura del 3% sull'imponibile a titolo di concorso **spese trasporto**.
- 3) L'importo degli ordini minimo con consegna prevista da sede centrale di Bonavigo è di **300,00 Euro imponibile**.
In caso di deroga per ordini inferiori all'importo minimo sarà addebitato a titolo di contributo fisso forfettario per "gestione ordine minimo", l'importo di 20,00 Euro.
- 4) **In caso di insoluti verranno innanzitutto bloccate tutte le spedizioni e tutti gli ordini in corso verranno automaticamente sospesi: al momento del pagamento/sblocco dell'insoluto, gli ordini avranno i tempi di consegna partendo dalla data di sblocco e ricalcolati con le fasce di consegna presenti nel listino.**
- 5) Il destinatario è obbligato a controllare la merce in arrivo e a contestare subito gli eventuali danni direttamente al trasportatore che ne è responsabile.
È diritto del destinatario e dovere del trasportatore controllare la spedizione (senza aprire l'imballo) e apporre le eventuali riserve specifiche sul DDT del trasportatore e quello Lineabeta. La sola dicitura generica: "RISERVA DI CONTROLLO" non è valida.
- 6) **Danno occulto:** nel caso di colli rovinati, solo esternamente, questi possono essere ritirati indicando sui DDT (documento di trasporto) del trasportatore e di Lineabeta la clausola "RISERVA CONTROLLO", **specificando la motivazione** per cui si è posta la riserva, come previsto dal regolamento (DPR 450 2/8/85) vigente. Nel caso di rotture accertate, il destinatario deve darne comunicazione scritta a mezzo raccomandata a SAMO S.p.A. e per conoscenza al trasportatore spedendola entro e non oltre 8 giorni dal ricevimento merce.
- 7) **Danno accertabile:** nel caso di danno evidente ed accertabile anche dal trasportatore, deve essere posta **una riserva sul DDT** del trasportatore e di Lineabeta indicando chiaramente **quantità e codici danneggiati ed il tipo di danno esterno ed interno riscontrato**.
Copia dei DDT devono essere inviati all'ufficio clienti Samo S.p.A. che successivamente darà le opportune disposizioni per l'eventuale sostituzione e reso del materiale.
- 8) Diversamente da quanto previsto ai paragrafi 6 e 7, Samo S.p.A. **non riconoscerà alcun rimborso** per danni o rotture riscontrate.
- 9) **Nessun articolo può essere reso senza l'autorizzazione scritta da Samo S.p.A.:** i resi autorizzati dovranno pervenire in porto franco al ns. stabilimento utilizzando il trasportatore ed il numero di riferimento comunicati da Lineabeta. Il numero di riferimento deve essere riportato sul documento di trasporto.
Se nell'accurato controllo Lineabeta si riscontrassero incurie dell'acquirente, **il materiale reso sarà gravato di un importo per la copertura delle spese generali** oltre ad eventuali spese di ripristino a nuovo.
- 10a) Gli ordini sono soggetti all'approvazione di Samo S.p.A.
Nessun ordine potrà essere annullato o modificato senza il consenso di Samo S.p.A., che si riserva la facoltà di addebitare eventuali oneri e spese che ne derivano.
La conferma dell'avvenuto annullamento o modifica, come anche dell'importo addebitato, sarà effettuata unicamente da Lineabeta in forma scritta.
- 10b) Il cliente-mittente referente della spedizione del reso deve rendere il **materiale autorizzato disponibile ed imballato idoneamente** per il trasporto **alla data di ritiro indicata nell'autorizzazione** concordata. In caso contrario, SAMO S.p.A. si riserva la facoltà di addebitare al cliente-mittente i costi di competenza conseguenti al mancato ritiro.
- 11) I prezzi di questo listino non sono contrattuali: **gli ordini vengono accettati a prezzi e condizioni** in vigore alla data di spedizione.
- 12) Per fatture inferiori a 300,00 Euro di imponibile, Samo S.p.A. si riserva la facoltà di **modificare le condizioni di pagamento**.
- 13) L'imballo normale è gratuito, eventuali imballi rinforzati saranno addebitati al costo.
- 14) **FASCE DI CONSEGNA INDICATIVE:**
tutti i prodotti Lineabeta sono selezionati per fasce (A-C) in funzione della disponibilità media di magazzino e dei tempi di preparazione e spedizione.
La fascia A (con più alto indice di rotazione) è evidenziata con il carattere del prezzo su sfondo azzurro e indica una consegna indicativa di 1 settimana dal momento della conferma ordine.
La fascia C (basso indice di rotazione) è evidenziata con carattere del prezzo su sfondo grigio e indica una consegna indicativa di 3-4 settimane.
- 15) I **termini fissati per la spedizione non sono tassativi** e in nessun caso possono costituire pretesto per ritardati pagamenti o richieste di risarcimento danni. Gli ordini possono essere anche evasi parzialmente.
- 16) In caso di particolari esigenze logistiche/operative, è possibile richiedere **consegne e spedizioni personalizzate** (pallettizzate, su ceste di ferro, con linea diretta, etc.) inviando una e.mail all'indirizzo servizioclienti@samo.it in modo da concordare tipologia, tempistiche ed eventuale maggiorazione per spese di trasporto e/o per spese di realizzo imballo.
- 17) **Le spedizioni vengono eseguite con il mezzo giudicato più idoneo da Samo S.p.A.** e la merce viaggia a rischio e pericolo del committente, anche se spedita per speciali accordi, franco destino.
- 18) **I prodotti non a catalogo e/o fabbricati su specifica richiesta del committente non possono essere restituiti.**
- 19) **I pagamenti dovranno essere effettuati puntualmente al domicilio di Bonavigo e secondo le condizioni stabilite:** qualsiasi contestazione non darà diritto all'acquirente di trattenere somme dovute per fatture in essere e/o scadute.

20) In mancanza di speciali pattuizioni il **pagamento si intende alla consegna.**

21) I **termini di pagamento dovranno essere tassativamente osservati.** Sui ritardati pagamenti decorreranno gli interessi legali aggiornati al momento (DL 9/10/2002 n° 231), salvo il diritto di Lineabeta di sospendere o annullare ogni altra consegna senza pregiudizio di ogni altra azione o diritto.

22) I **prodotti forniti rimangono di proprietà di Samo S.p.A. fino ad integrale pagamento del prezzo, come previsto dal C.C. art. 1523 e segg.**

23) **Garanzia.** Lineabeta garantisce i propri prodotti per **24 mesi a decorrere dalla data d'acquisto** e comunque entro i limiti del DPR 224 24/05/88 e secondo le direttive Europee.

La garanzia copre esclusivamente vizi e difetti di fabbricazione o assemblaggio.

Difetti estetici o strutturali devono essere comunicati per iscritto a Lineabeta solo ed esclusivamente prima dell'installazione, allegando i documenti di acquisto e di prodotto.

24) La garanzia **impegna Samo S.p.A. solo alla riparazione e/o alla sostituzione degli elementi difettosi:** sono pertanto escluse ulteriori pretese da parte dell'acquirente, ed esclude qualsiasi indennizzo derivato dal disagio, od onere o costo relativo accessorio.

La non conformità dovrà essere riconosciuta solo da parte di personale autorizzato da Samo - Lineabeta.

25) **Sono comunque esclusi dalla garanzia i seguenti casi:**

- Se il difetto è riconducibile al trasporto.
- Rotture di tutte le parti in vetro temperato, in particolare causate da impatto, urti durante il trasporto, movimentazione manuale degli elementi in fase di installazione e impatti accidentali durante l'utilizzo.
- Se l'installazione non è stata eseguita dettagliatamente secondo istruzioni Samo - Lineabeta.
- Se il vizio di funzionamento è conseguente ad un intervento sul prodotto non autorizzato.
- Se il funzionamento difettoso è conseguente alla normale usura del prodotto, alla negligenza o incuranza da parte dell'acquirente nel rispetto delle indicazioni allegate al prodotto.
- Se il difetto è riconducibile all'utilizzo di detergenti abrasivi, a base acida, o prodotti non adatti alla pulizia di superfici laccate, verniciate, anodizzate e vetrose.
Si consiglia l'utilizzo di articoli per la cura del prodotto a marchio Samo - Lineabeta.
- Se il funzionamento difettoso è conseguente a forze maggiori.
- Manomissione del prodotto da parte dell'acquirente.

26) **Samo S.p.A. declina qualsiasi responsabilità per eventuali danni a persone, animali o cose** causati da errori di installazione, di regolazione, imperfetto utilizzo o la mancata osservanza di tutte le prescrizioni indicate nella documentazione allegata al prodotto.

27) Samo S.p.A. si riserva il diritto di **apportare modifiche tecniche ed estetiche ai propri prodotti** in qualsiasi momento senza preavviso, ivi comprese modifiche a volume e peso.

28) **Ogni eventuale pattuizione** che possa derogare, in tutto o in parte, alle presenti condizioni generali, **deve risultare da espreso accordo scritto.**

29) **Il presente listino prezzi annulla tutti i precedenti ed è valido solo per vendite a ditte italiane.**

30) Per ogni controversia è competente unicamente il **Foro di VERONA - ITALIA.**

31) Ai sensi della legge DL 196/2003 Lineabeta dichiara che i dati messi a disposizione dal committente verranno elaborati in rispetto della **legge sulla tutela della privacy.**

32) **Tutte le suddette condizioni di vendita si intendono integralmente accettate con il conferimento dell'ordine.**

GENERAL TRANSPORT AND SALE TERMS

ENG

- 1) The published prices on the present price list are in Euro, exclusive of VAT. The prices are not binding and the goods are delivered ex-works Italy.
- 2) If the products are transported by Samo S.p.A. or by uncharged forwarder to the client destination, the transport cost will be debited on the invoice with a participation quote.
- 3) The minimum order amount with delivery ex-Samo factory is 300,00 Euro.
- 4) In case of non-payment, shipments will be stopped and orders in progress will be suspended. Upon receipt of payment the delivery of the orders will be calculated with a new delivery period as per price list specification, taking the date of payment receipt.
- 5) In case exceeding of the agreed credit line, orders will still be accepted by SAMO S.p.A., related shipments will be stopped upon the receipt of a sufficient amount needed to recover into the credit line.
- 6) Deliveries must be immediately inspected, in case of wrong items, and/or shortages, and/or any defect, have to be reported to the forwarder which is the only responsible for it. It is in the right of the receiver and the duty of the forwarder to control the delivery (without opening the package). A formal making specific notification on the delivery notes, the generic written phrase "subject to inspection" is not sufficient.
- 7) **Hidden damage:** if on delivery, the goods display obvious packaging defects, they can be withdrawn, but the receiver is obliged to note the defects on the PoD marking them with "SUBJECT TO INSPECTION" and specifying reason why, as preview by the European norms in use. In case of proven breakages, the receiver must communicate it in written with a registered letter to SAMO S.p.A. and copy to the forwarder in within 7 days from the reception of the goods.
- 8) **Verified damage:** in case of evident damage verified by the receiver and the forwarder, the damage evidence must be duly marked on PoD, indicating very clearly the quantity and the damaged products codes, verifying if the damage type is occurred on the internal or external side. A further copy of PoD must be sent to Samo S.p.A. customer service that, successively will arrange the possible replacement upon reception of the damaged goods.
- 9) Unlike what is clearly specified on the paragraphs 7 and 8, Samo S.p.A. will not recognised any refund for the verified damage or breakage.
- 10) Any Item can be returned without Samo S.p.A. written permission. Authorised returns must be sent to our warehouse with transport fees paid, using SAMO authorised forwarder, indicating the communicated reference number. The reference number must be absolutely reported on PoD. Returns must be perfectly packaged. After SAMO control and in case of verified purchaser's neglect, the returned good will be charged of an amount equal to recover general expenses and any possible restoration costs.
- 11) Orders must be approved by Samo S.p.A.. No order can be cancelled without SAMO approval, which reserves the right to debit any charges and expenses caused by such cancellation.
- 12) Orders are intended as per commercial conditions in use at the moment of the order acceptance or release.
- 13) Samo S.p.A. reserves the right to change the payment terms for orders below 300,00 Euro.
- 14) Normal packaging is free; any reinforced packaging will be charged at the cost.
- 15) **INDICATIVE PRODUCTION TERMS:**
all Lineabeta products are selected by different production terms (A-C) in accordance to the manufacturing times table.
Band A is highlighted with price character on light-blue background and has an indicative production time of 1 week starting from order confirmation.
Band C is highlighted with the price character on gray background and has an indicative production time of 3-4 weeks.
- 16) The mentioned delivery terms are not binding SAMO S.p.A. and absolutely in no case they constitute an excuse for payment delays or damages or complains compensation. The orders may be also partially fulfilled.
- 17) It is possible to require personalized deliveries and/or transports (pallets, iron baskets, with direct line, etc...) by sending an e-mail to Lineabeta address export@samo.it agreeing typology, terms and any possible increases for transport and/or packing costs.
- 18) The goods travel always at the consignee's risk even if they are sent for special agreements as "free delivery".
- 19) Any return of any special, or out of catalogue product will be accepted.
- 20) Payments shall be made by bank transfer and accordingly to specific commercial conditions in use. Any dispute will not give the buyer the right to deduct any amounts from the due expired or expiring invoices.

- 21) Unless otherwise agreed, **the payments shall be made in advance.**
- 22) **The agreed payment terms shall be strictly observed. In case of payment delay, will be charged interests as per Italian and European norms valid,** giving to Samo S.p.A. the full right to suspend any kind of delivery without any prejudicial and any other kind of action or right.
- 23) **The supplied products remain of Samo S.p.A. property until the full payment is received in accordance** to the Italian and European norms.
- 24) **Warranty.** Lineabeta guarantees its products **for 24 months from the date of delivery** according to the European directives. **The warranty exclusively covers manufacturing irregularities or material defects.**
Aesthetic or functional defects must be communicated **in writing** to Lineabeta only and exclusively before installation, enclosing purchase and product documents.
- 25) **Samo S.p.A. warranty will be exclusively valid for the repair or the replacement of defective elements:** no other purchaser claims shall be considered, absolutely excluding any derived discomfort, burden or accessory cost.
The claimed non-compliance must be recognised by Lineabeta authorized technical personnel.
- 26) **Lineabeta warranty lapses automatically in following cases:**
- If defect has reference to transport;
 - Tempered glass parts breakages;
 - If installation isn't performed following in detail Samo - Lineabeta instruction;
 - If functioning defect is due to unauthorized technical intervention on product;
 - If defective functioning is due to the normal product usury, or to the purchaser negligence or carelessness following product indication;
 - If defect is due to the use of acid based or abrasive detergents, or cleaning products not suitable for glass, anodized, lacquered or varnished surfaces. Use of Samo - Lineabeta cleaning products is suggested;
 - If defective functioning is due to a "force majeure" reason;
 - Purchaser manumission of the product.
- 27) **Samo S.p.A. declines any responsibility for possible people, animals or goods damage** due to installation or adjustments errors, imperfect use or no observance of all prescriptions indicated in product enclosed documents
- 28) **Samo S.p.A. reserves the full right to technically and aesthetically modify the product at anytime and without previous notice,** including changes in volume and weight.
- 29) Any **possible agreement variation** that totally or partially change the present general condition, shall be resulted exclusively by written agreement.
- 30) **This price list invalidate and cancel all previous.**
- 31) For any dispute, the only competent jurisdiction is the **Court of Verona-Italy.**
- 32) **In reference to the valid European norms, Lineabeta declares that the information made available by the client will be processed according to the law on the protection of privacy.**
- 33) **All the above-mentioned terms and conditions of sale are intended as having been fully accepted with the confirmation of the order.**

CONDITIONS GENERALES DE VENTE ET DE TRANSPORT

FRA

1) Les prix HT indiqués en Euro dans ce tarif sont donnés sans engagement de durée et s'entendent pour marchandises départ dépôt SAMO FRANCE (Aix-en-Provence ou Paris),

2) La marchandise d'une valeur inférieure à 300 Euros expédiée en port Franco sera grevée d'un débit en facture au titre de participation aux frais de transport.

3) Conditions de livraison en FRANCE (départ Aix-en-Provence ou Paris)

| | |
|----------------------|--|
| de 0 à 150 Euros | Port dû |
| de 151 à 300 Euros | Port Franco avec débit 20 € en facture |
| au delà de 300 Euros | Port Franco |

4) Pour des commandes d'un montant inférieur à 150 Euros, la livraison sera toujours en PORT DÛ et le paiement sera obligatoirement à 30 jours.

Le défaut de paiement d'une seule échéance rend toutes les autres immédiatement exigibles et Lineabeta se réserve le droit de suspendre ou d'annuler les commandes en cours, sans préjudice de tout autre recours.

5) En cas de défaut de règlement, les expéditions seront bloquées et les commandes en cours seront suspendues.

Lorsque le règlement interviendra, les commandes verront leur délai de livraison recalculé, selon les classes de fabrication mentionnées dans le tarif, à partir de la date de déblocage des commandes.

6) En cas de dépassement du crédit-encours maximum accordé, les commandes devront toujours être acceptées par Lineabeta

Par contre, les expéditions seront suspendues jusqu'au règlement d'au moins le montant nécessaire pour atteindre à nouveau le crédit-encours maximum accordé.

7) Au cours de l'exécution d'un marché, avant ou pendant les livraisons, nous nous réservons le droit de réclamer de l'acheteur caution bonne et solvable du prix des fournitures faites ou à faire et, en cas de refus, de résilier le marché.

Toute contestation concernant la facturation devra être formulée par écrit et dans les quinze jours de la réception de la facture par le client, sous peine d'irrecevabilité.

8) Il incombe au destinataire de vérifier l'état des marchandises à l'arrivée, en présence du livreur.

Le destinataire doit, par conséquent, ouvrir et vérifier la marchandise à la livraison devant le transporteur.

9) En cas de casse ou d'avarie, le destinataire doit impérativement le noter sur le récépissé de transport et sur le bon de livraison, et refuser le ou les colis cassés ou abîmés. En cas de colis manquant, le destinataire doit l'indiquer sur le récépissé de transport et sur le bon de livraison.

10) En France, l'Article 105 du Code du Commerce stipule que les réserves portées sur le récépissé de transport et sur le bon de livraison doivent être suffisamment claires, précises et explicites.

Exemple de réserves admises « refusé car colis cassé », « refusé car produit abîmé », « manque 1 colis ».

Attention, la mention « sous réserve de déballage » ne pourra en aucun cas être prise en compte en cas de litige car elle n'est pas admise par les tribunaux.

Toujours selon l'Article 105 du Code du Commerce en France, une confirmation des réserves par Lettre Recommandée avec Accusé de Réception doit être expédiée au transporteur dans les 48 heures suivant la réception de la marchandise et une copie doit nous en être adressée.

11) En l'absence de réserves expressément prévues sur le récépissé de transport et sur le bon de livraison, notre responsabilité ne pourra en aucun cas être engagée et toute réclamation ne pourra être prise en compte et donner lieu à une substitution gratuite de l'Article.

12) Les commandes sont sujettes à acceptation de SAMO FRANCE .

Aucune commande ne pourra être annulée ou modifiée sans le consentement de SAMO FRANCE , qui se réserve le droit de facturer les éventuels frais inhérents.

La confirmation de l'acceptation de modifications ou annulations et la facturation d'éventuels frais supplémentaires, sera confirmée par Lineabeta uniquement par écrit.

En cas d'acceptation écrite par Lineabeta de retour de marchandises, le client-expéditeur devra mettre à disposition et correctement emballé pour le transport, le matériel autorisé en retour à la date de retrait indiquée sur l'autorisation de retour.

Dans le cas contraire, Lineabeta se réserve le droit de facturer au client-expéditeur les coûts engendrés par la présentation du transporteur.

13) Les commandes sont soumises à l'approbation de Lineabeta.

Aucune commande ne pourra être annulée sans l'accord de Lineabeta qui se réserve la faculté de débiter les éventuels frais et charges qui en découleraient.

14) Les prix indiqués dans ce tarif ne sont pas contractuels: les commandes sont acceptées aux prix et aux conditions en vigueur au jour de l'expédition.

15) Pour les factures d'un montant inférieur à 300 euros, SAMO FRANCE se réserve la faculté de modifier ses conditions de paiement.

16) L'emballage normal est gratuit, les éventuels emballages renforcés seront facturés en supplément.

17) Comment interpréter les CLASSES DE FABRICATION :

tous les produits « Lineabeta » sont regroupés par classes (A-C) en fonction de leur disponibilité moyenne en magasin et des délais de fabrication, préparation et expédition.

La classe A (avec l'indice de rotation le plus élevé) est caractérisée par un prix sur fond bleu et indique un délai de fabrication indicatif de 1 semaine à compter de la confirmation de la commande.

La classe C (indice de rotation faible) est caractérisée par un prix sur fond gris et indique un délai de fabrication indicatif de 3-4 semaines.

18) Les délais de fabrication, ainsi que les délais de transport sont donnés à titre purement indicatif et ne constituent, en aucun cas, un engagement de notre part.

Aussi, ils ne peuvent être pris comme prétexte pour des annulations de commande, des retards de paiement ou des demandes de dédommagement.

Les commandes pourront être exécutées même partiellement sans que cela puisse constituer une cause d'annulation.

19) Il est possible de demander des livraisons et des expéditions personnalisées (sur palette, sur chariot métallique, en direct, etc...) en envoyant un e-mail à l'adresse de SAMO FRANCE de manière à définir le mode d'expédition, les délais de livraison et à obtenir un devis relativement aux frais de transport et/ou aux frais de préparation et de confection d'emballages spécifiques.

20) Les expéditions seront effectuées par les moyens que SAMO FRANCE jugera les plus indiqués et la marchandise voyagera aux risques et périls du client, même si elle est expédiée en franco-destination selon des accords particuliers.

21) Les produits hors catalogue et/ou fabriqués selon une demande spécifique du client ne pourront en aucun cas faire l'objet d'une restitution.

22) Les paiements doivent être effectués directement auprès de la société SAMO FRANCE.

23) Sauf accord particulier les paiements s'effectuent à la livraison.

24) En cas de retard de paiement à l'échéance convenue, SAMO FRANCE sans mise en demeure préalable, percevra des pénalités de retard égales au taux d'intérêt appliqué par la Banque Centrale Européenne (BCE) à son opération de refinancement la plus récente majorée de 10 % ainsi qu'une indemnité forfaitaire pour frais de recouvrement (Décret n°2012-1115 du 2 octobre 2012) calculées à partir de la date à laquelle le règlement aurait dû intervenir et sans préjudice des dépenses qui seraient à la charge du débiteur en cas d'action judiciaire. Si les frais de recouvrement s'avéraient supérieurs à 40 euros, Lineabeta se réserve le droit de demander sur justifications une indemnité complémentaire.

25) Nos marchandises sont vendues avec une clause subordonnant expressément le transfert de leur propriété au paiement intégral du prix en principal et accessoires.

Ne constitue pas paiement au sens de cette clause, la remise d'un titre créant une obligation de payer (traite ou autre).

En conséquence, les marchandises livrées restent notre propriété jusqu'à ce que le titre ait été effectivement payé.

Nous nous réservons le droit, à défaut de paiement d'une seule fraction du prix et quinze jours après mise en demeure restée infructueuse, de considérer la vente comme résiliée de plein droit, et d'obtenir restitution des marchandises livrées, avec ou sans ordonnance rendue, en France, par le Président du Tribunal de Commerce de Aix-en-Provence.

L'éventuelle reprise par le vendeur des marchandises vendues en réserve de propriété impose à l'acheteur l'obligation de réparer le préjudice résultant de la dépréciation et de l'indisponibilité des biens concernés.

Pour la FRANCE : Loi n° 80-335 du 12 mai 1980, loi du 10 juin 1994, Code du Commerce art. L-122, loi du 1er juillet 1996.

26) Garantie. SAMO FRANCE garantit ses propres produits pour une période de **24 mois à compter de la date d'achat**, selon les dispositions du Code Civil et des directives Européennes en la matière.

La garantie couvre exclusivement les vices et défauts de fabrication ou d'assemblage.

Les défauts d'ordre esthétique ou structurel doivent être communiqués par écrit à **SAMO FRANCE** seulement et exclusivement avant l'installation, en y alléant les documents d'achat et de produit.

27) La garantie engage SAMO FRANCE seulement à la réparation et/ou au remplacement des éléments défectueux : sont cependant exclues les prétentions supplémentaires de la part de l'acquéreur, et exclus toute demande d'indemnisation dérivant de la gêne occasionnée, ou charge ou coût accessoire relatif.

La garantie ne couvre pas les frais de main-d'œuvre et ceux résultant des opérations suivantes : démontage, remontage, transport sur site, etc....

La non conformité devra être identifiée et confirmée uniquement par du personnel autorisé par **Lineabeta**.

28) Sont cependant exclus de la garantie les cas suivants :

- si le défaut est dû au transport;
- casse des parties en verre trempé;
- si l'installation n'a pas été effectuée scrupuleusement selon les instructions de **Samo - Lineabeta**;
- si le vice de fonctionnement résulte d'une intervention sur le produit effectuée sans autorisation;
- si le fonctionnement défectueux provient de l'usure normale du produit, d'une négligence ou d'un défaut d'entretien de la part de l'acheteur eu égard aux indications alléguées au produit;
- si le défaut résulte de l'utilisation de détergents abrasifs, à base acide, ou de produits non adaptés à l'entretien de surfaces laquées, vernies, anodisées ou vitrées. Est conseillée l'utilisation des produits d'entretien de marque « **Samo - Lineabeta** »;
- si le fonctionnement défectueux résulte de la force majeure;
- altération, modification du produit du fait de l'acquéreur.

29) SAMO FRANCE décline toute responsabilité pour d'éventuels dommages causés à des personnes, des animaux ou des objets et dus à des erreurs d'installation, de réglage, à une utilisation inappropriée ou à la carence d'observation des prescriptions indiquées dans la documentation alléguée au produit.

30) Les acheteurs et revendeurs successifs du produit sont invités à insérer en pied de leurs factures de vente le montant de l'écocontribution acquittée par le metteur sur le marché du produit et à informer les acheteurs successifs que cette écocontribution, déjà acquittée par le metteur sur le marché, permet la collecte et le traitement gratuit du produit en fin de vie.

Les opérateurs qui assurent l'incorporation, la pose ou l'installation des produits concernés dans un ouvrage, sont invités à faire figurer dans leur facture la mention suivante : « Le prix de la prestation et des matériaux intègre la contribution environnementale obligatoire selon l'article L 541-10-1 4° Code de l'Environnement, acquittée par l'entreprise responsable de la mise sur le marché des produits et matériaux. Cette contribution environnementale permet de financer le dispositif de tri, de réutilisation ou de recyclage, conformément aux dispositions des articles R543-288 et suivants du code de l'environnement. » Numéro d'immatriculation au registre national des metteurs sur le marché de l'ADEME pour la filière Bâtiment catégorie 1 (inertes) et la filière Bâtiment catégorie 2 (non inertes) : FR303408_04ACRB. Numéro d'immatriculation au registre national des metteurs sur le marché de l'ADEME pour les éléments d'ameublement : FR303408_10MSLC.

31) Photos non contractuelles. Sous réserve des écarts de couleurs liés aux techniques d'impression.

SAMO FRANCE se réserve le droit d'apporter des modifications techniques et esthétiques à ses propres produits à tout moment et sans préavis, y compris les changements dans le volume et le poids

32) Toute éventuelle négociation qui viendrait déroger, en totalité ou en partie, à ces Conditions Générales de Vente devra expressément faire l'objet d'un accord écrit de la part de SAMO FRANCE.

33) Cette liste de prix annule et remplace tous les précédents tarifs.

34) En cas de contestation, compétence exclusive, pour la FRANCE est donnée au Tribunal de Commerce de Aix-en-Provence et Loi applicable est la Loi Française.

35) SAMO FRANCE déclare que les informations mises à sa disposition seront utilisées en vertu des dispositions de la Directive Européenne en matière d'Informatique et de Liberté.

36) Les présentes Conditions Générales de Vente sont considérées comme acceptées par l'acheteur au moment de la commande.

ALLGEMEINE VERKAUFS UND GESCHÄFTSBEDINGUNGEN

DEU

1) Die in dieser Preisliste in Euro genannten Preise sind unverbindlich und gelten für arenlieferungen ab Werk SAMO S.p.A. in Italien, zuzüglich der jeweils gültigen MEHRWERTSTEUER.

2) Wird die Ware frei Bestimmungsort gesendet, wird eine Belastung in der Rechnung zu den in Italien gültigen Transport und Versandkosten, belastet werden.

3) Der Netto Mindestbestellwert für Ab Werk SAMO S.p.A. Bestellungen ist 300,00 €.

4) Im Fall von Zahlungsrückständen wird der Versand, sowie die laufenden Bestellungen gestoppt: Nach Zahlung der offenen Posten werden die Bestellungen entsprechend der Lieferungszeiten, gemäß den in dieser Preisliste angezeigten Lieferfristen vom Datum des Stopps aus wieder neu berechnet.

5) Im Fall der Überziehung des vereinbarten Kreditlimits werden die Bestellungen von SAMO S.p.A. zwar angenommen: der Versand wird dagegen bis zur Zahlung eines ausreichenden Betrages, um das vereinbarte Kreditlimit wieder zu erreichen, zurückgehalten.

6) Der Empfänger ist verpflichtet, die Ware bei Eingang zu überprüfen und eventuelle Schäden sofort und direkt bei dem Frachtführer zu beanstanden, der hierfür verantwortlich ist.

Es ist Recht des Empfängers und Pflicht des Frachtführers den Versand (ohne die Verpackung zu öffnen) zu kontrollieren und den eventuellen Vorbehalt im Frachtführer und SAMO S.p.A. Lieferschein daneben zu stellen: allein die allgemeine Aufschrift: "Kontrollvorbehalt" gilt nicht.

7) **Verdeckte Schäden:** im Fall von äußerlich beschädigten Verpackungen, können diese entgegengenommen werden, wobei auf dem Lieferschein der Vermerk „KONTROLLVORBEHALT“ und die Begründung des Vorbehalts vermerkt werden muß, wie vom geltenden Gesetz vorgesehen.

Bei eindeutigen ermittelten Bruchschäden muss der Empfänger durch Einschreibebrief an SAMO S.p.A. und, zur Kenntnisnahme, dem Frachtführer die entsprechende Mitteilung machen, und ihn innerhalb von 8 Tagen nach Erhalt der Ware zusenden.

8) **Sichtbarer Schaden:** Im Fall von deutlich, feststellbarem Schäden muss auch Seitens des Frachtführers ein Vorbehalt im Lieferschein vermerkt werden, in der die Menge, die beschädigten Teile, sowie innere oder äußere Schäden klar zu bezeichnen sind. Kopien des Lieferscheins müssen an SAMO S.p.A. geschickt werden, das darauf hin die geeigneten Maßnahmen für den eventuellen Ersatz oder Warenrücksendung treffen wird.

9) Bei Nichtbeachtung der Paragraphen 9 und 10 erkennt SAMO S.p.A. keine Erstattung für Schäden an.

10) **Kein Artikel wird ohne das schriftliche Einverständnis von SAMO S.p.A. zurückgenommen:** genehmigte Rücknahmen müssen unserem Werk frachtfrei mit der Angabe des Frachtführers und der von SAMO S.p.A. mitgeteilten Bezugsnummer zugehen.

Die Bezugsnummer soll im Lieferschein vermerkt werden.

Für Annahme und Bearbeitung von Rücksendungen werden generell Rücksendungskosten in Rechnung gestellt, die sich nach dem Zustand der zurück gesendeten Ware richten.

11) Die Bestellungen müssen von SAMO S.p.A. bestätigt sein.

Keine Bestellung kann ohne SAMO S.p.A. Zustimmung annulliert werden, wobei SAMO S.p.A. sich vorbehält, eventuelle Kosten und Ausgaben, die sich hieraus ergeben sollten, in Rechnung zu stellen.

12) Bestellungen bedürfen der Annahme durch die SAMO S.p.A..

Die Stornierung oder Änderung von Bestellungen ist unzulässig, wenn nicht die Zustimmung der SAMO S.p.A. vorliegt, die sich das Recht vorbehält, daraus entstehende Aufwendungen und Gebühren in Rechnung zu stellen.

Die erfolgte Stornierung oder Änderung wird ebenso wie der belastete Betrag einzig von SAMO S.p.A. in schriftlicher Form bestätigt.

13) Bei Rechnungen unter Euro 300,00 behält sich SAMO S.p.A. die Möglichkeit vor, die Zahlungsbedingungen zu ändern.

14) Die Normalverpackung ist kostenlos, eventuelle verstärkte Verpackungen werden zum Selbstkostenpreis in Rechnung gestellt.

15) UNGEFÄHRE LIEFERZEITEN AB WERK:

Alle Produkte SAMO S.p.A. werden in verschiedenen Klassen (A-B-C) in Funktion des durchschnittlichen Lagerbestands und der Vorbereitungs- und Versandzeiten unterteilt.

KLASSE A (mit dem höchsten Rotationsindex) ist in der Preisliste durch blauen Hintergrund hervorgehoben und bezeichnet so eine ungefähre Liefenzeiten Ab Werk in 1 Woche ab der Bestätigung der Bestellung.

KLASSE B ist in Preisliste durch rosafarbenen Hintergrund hervorgehoben und bezeichnet so eine ungefähre Liefenzeiten Ab Werk in 2-3 Wochen ab der Bestätigung der Bestellung.

KLASSE C (niedriger Rotationsindex) ist in der Preisliste durch den weißen Hintergrund hervorgehoben und bezeichnet so eine ungefähre Liefenzeiten Ab Werk in 3-4 Wochen.

Der unmittelbare Lagerbestand kann durch senden einer e-mail an die Adresse: export@samo.it angefragt werden.

Für die Produkte mit der Behandlung Starclean, ist es notwendig, eine andere Lieferungswoche in Bezug auf die Zugehörigkeitsklasse des Artikels Kodex zu berechnen.

16) Die festgelegten Versandfristen sind nicht bindend und rechtfertigen in keinem Fall den Anspruch auf Zahlungsverzögerung oder Schadensersatz: die Aufträge können auch in Teillieferungen erledigt werden.

- 17) Es ist möglich, spezielle **Lieferungen und Versandbedingungen** (in Paletten, auf Eisenkörbe, mit direkter Linie, usw.) zu erhalten, senden Sie eine e-mail an die Adresse **export@samo.it**, um Art, Zeiten und eventuelle Zuschläge für Transport- und/oder Verpackungskosten zu erfahren.
- 18) **Der Warentransport geht auf Risiko und Gefahr des Auftraggebers, auch bei Versand nach Sonderabsprachen, frei Bestimmungsort.**
- 19) **Produkte, die nicht im Katalog enthalten sind oder auf besonderen Wunsch des Auftraggebers anfertigt wurden, können nicht zurückgenommen werden.**
- 20) **Die Zahlungen müssen zu den festgelegten Bedingungen an SAMO S.p.A. erfolgen:** jegliche Beanstandung gibt dem Käufer nicht das Recht auf die Einbehaltung der für fällige Rechnungen ausstehenden Beträge.
- 21) Wenn nicht anders vereinbart **gilt die Vorkasse Zahlung.**
- 22) **Die Zahlungsfristen sind strikt einzuhalten.**
Bei Zahlungsverzögerungen werden die jeweils geltenden.
Verzugszinsen in Anrechnung gebracht, vorbehaltlich des Rechts von SAMO S.p.A., jegliche weitere Lieferung zu stoppen oder zu annullieren, unbeschadet des Rechts auf jede sonstige Maßnahme oder Anspruch.
- 23) **Die gelieferten Produkte bleiben bis zur vollständigen Bezahlung Eigentum von SAMO S.p.A..**
- 24) **Garantie.** SAMO S.p.A. garantiert für ihre Produkte 24 Monate ab Lieferung und gemäß DPR 224 24/05/1988 (Italien) im Rahmen der europäischen Richtlinien.
Die Garantie deckt insbesondere Fabrikationsfehler und Materialdefekte ab.
Ästhetische oder funktionale Defekte müssen vor Installation **schriftlich direkt** an SAMO S.p.A. mitgeteilt werden, **unter Beilage der Liefersdokumente und Produktdokumente.**
- 25) **Die SAMO S.p.A. Garantie gilt ausschließlich für die Reparatur oder den Ersatz der defekten Elemente:** andere Forderungen oder Reklamationen der Erwerber werden nicht anerkannt, daraus abgeleitete Unannehmlichkeiten, Belastungen oder Nebenkosten werden ausdrücklich abgelehnt.
Die Übereinstimmung der Reklamation muss durch autorisiertes Personal von SAMO bestätigt werden.
- 26) **Die SAMO S.p.A. Garantie erlöscht automatisch in folgenden Fällen:**
- im Falle von Transportschäden;
 - bei Bruch von ESG-Teilen;
 - wenn die Montage nicht gemäß den Anleitungen von Samo - Lineabeta vorgenommen wurde;
 - bei Auftreten eines technischen Defekts auf Grund von unbefugten technischen Veränderungen am Produkt;
 - im Falle von üblichen Verschleißerscheinungen, sowie bei unsachgemäßer und unvorsichtiger Behandlung des Produkts durch den Benutzer;
 - bei Verwendung von säurehaltigen oder aggressiven Reinigungsmitteln oder Waschsubstanzen, die für Glas, eloxierte, lackierte oder verschönerte Oberflächen nicht geeignet sind. Die Verwendung von Samo - Lineabeta Reinigungsprodukten wird empfohlen;
 - Defekte, die durch höhere Gewalt entstehen;
 - wenn das Produkt durch den Erwerber nicht bezahlt wurde;
- 27) **SAMO S.p.A. lehnt jegliche Verantwortung für mögliche Personen- oder Sachschäden ab,** die auf Grund von Installations- oder Montagefehlern, unsachgemäßen Gebrauch oder mangelhafte Wartung entstehen.
- 28) SAMO S.p.A. behält sich vor, jederzeit ohne jegliche Vorankündigung **technische oder design Änderungen an den eigenen Produkten vorzunehmen**, einschließlich der Änderungen in Volumen und Gewicht.
- 29) **Jegliche eventuelle Vereinbarung, die ganz oder teilweise von den vorliegenden allgemeinen Bedingungen abweichen kann, muss ausdrücklich schriftlich vereinbart werden.**
- 30) **Diese Preisliste ersetzt alle vorherigen Preislisten.**
- 31) Für jegliche Streitfragen ist der **Gerichtsstand von VERONA – ITALIEN**, oder ein anderes von SAMO bestimmtes entsprechend der Notwendigkeit gewähltes Gericht, zuständig.
- 32) **In Übereinstimmung mit dem geltenden** Gesetz erklärt SAMO S.p.A., dass die vom Auftraggeber zur Verfügung gestellten Daten unter Haltung des Datenschutzgesetzes verarbeitet werden.
- 33) **Die obengenannten Bedingungen gelten bei der Auftragserteilung als vollständig akzeptiert.**



SAMO S.P.A.
Via Cav. Orvile Venturato, 1
37040 BONAVIGO (VR) - ITALY
Tel. +39 (0) 442 73018
Fax +39 (0) 442 670033
www.samo.it - samo@samo.it
e-mail: export@samo.it

SAMO FRANCE S.a.r.l.
735, rue Georges Claude
Z.I. Les Milles
13290 Aix-en-Provence
Tel. (+33) 491 04 91 58 20 63
commercial@samofrance.fr

LEGENDA

Legend / Legende / Légende

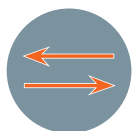

Reversibile
Reversible
Réversible
Umkehrbar



Installazione non reversibile
Not reversible installation
Installation non réversible
NICHT reversible installation



Chiave
Key
Clé
Schlüssel



Soffione
Shower head
Pommeau de douche
Kopfbrause

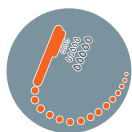

Doccino
Hand shower
Handbrause
Douchette Handbrause

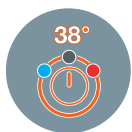

Miscelatore termostatico
Thermostatic mixer
Mitigeur thermostatique
Thermostat Mischbatterie



Miscelatore meccanico
Mechanical mixer
Mitigeur mécanique
Mechanische Mischbatterie

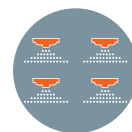

Nebulizzatori
Drops spraying
Brumisation
Nebeldüsen



Regolazione del colore della luce
Light color adjustment
Réglage de couleur
Lichtfarbregelung



Temperatura del colore della luce
Color temperature
Température de couleur
Lichtfarbtemperatur



Temperatura del colore della luce
Color temperature
Température de couleur
Lichtfarbtemperatur



Temperatura del colore della luce
Color temperature
Température de couleur
Lichtfarbtemperatur



Temperatura del colore della luce
Color temperature
Température de couleur
Lichtfarbtemperatur



IP20
IP20
IP20
IP20



IP44
IP44
IP44
IP44



Regolazione dell'intensità della luce
Light intensity adjustment
Réglage de l'intensité lumineuse
Lichtintensitätsregelung



LED sostituibili
Replaceable leds
LED remplaçables
Austauschbare LEDs



Presca Elettrica
Electrical Outlet
Prise Électrique
Steckdose

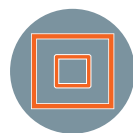

Marchio Classe II
CLASS II mark
Label CLASSE II
KLASSE II Kennzeichnung



Accensione da interruttore
Switch on
Allumer
Einschalten



Sistema autocentrante
Self-centering-system
Système d'auto-centrage
Selbstschliessendes System



Scopino sostituibile
Replaceable Toilet Brush
Brosse de toilette remplaçable
Austauschbare Toilettenbürste



Scopino magnetico
Magnetic Toilet Brush
Brosse de toilette magnétique
Magnetische Toilettenbürste

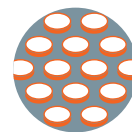

Base antiscivolo
Non-slip Base
Base antidérapante
rutschfeste Unterlage



Kit incollo
Gluing kit
Kit de collage
Klebeset



Accensione con tastiera
Activation by keyboard
Panneau de contrôle tactile
Anschalten durch eine Tastatur



Adatto a portatori di handicap
Suitable for disabled people
Adapté aux personnes handicapées
Geeignet für Behinderte

LEGENDA

Legend / Legende / Légende



Novità
New
Nouveauté
Neuheit



Made in Italy
Made in Italy
Made in Italy
Made in Italy



Made in Europe
Made in Europe
Made in Europe
Made in Europe



Marcatura CE
CE mark
Label CE
CE Kennzeichen



Fissaggio a muro
Wall mounting with screws
Fixation murale par vis
Wandbefestigung mit Schraube



Incollo a muro
Wall adhesive
Fixation murale avec colle
Wand Kleber



Acciaio 304
Steel 304
Acier 304
Stahl 304



Acciaio 316
Steel 316
Acier 316
Stahl 316



Touch
Touch
Touch
Touch



Articolo con led
Article with leds
Article avec led
électroluminescentes
Artikel mit LED



Led freddo
Led cold
Led froide
Led kalt



Led caldo
Led warm
Led chaude
Warme Led



Ad Acqua
Water
Eau
Wasser



Elettrico
Electric
Électrique
Elektrisch



Design essenziale
Essential design
Design essentiel
Schlichtes Design



Saldatura laser
Laser welding
Soudure laser
Laserschweißen



Alta efficienza energetica
High energy efficiency
Haute économie d'énergie
Hohe Energieeffizienz



Facile da installare
Easy to install
Facile à installer
Einfach zu installieren



Facile da pulire
Easy to clean
Facile à nettoyer
Einfach zu säubern



Uso versatile
Versatile placing
Utilisation polyvalente
Vielseitig Platzierung

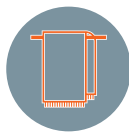

Portasalvietta
Towel holder included
Porte-serviettes inclus
Handtuchhalter enthalten



Ingranditore 3X
Magnifying 3X
Grossissant 3X
Vergrößerungsspiegel 3X



Ingranditore 5X
Magnifying 5X
Grossissant 5X
Vergrößerungsspiegel 5X



Ingranditore 8X
Magnifying 8X
Grossissant 8X
Vergrößerungsspiegel 8X



lineabeta



SAMO S.P.A. Via Cav. Orvile Venturato, 1 - 37040 BONAVIGO (VR) - ITALY
Tel. +39 (0) 442 73018 Fax +39 (0) 442 670033

www.samo.it/it/brand/Lineabeta