









Trimline 140 Corner/Panoramic

THIS FIREPLACE WARMS NOT ONLY YOUR INTERIOR, BUT YOUR HEART AS WELL













Product specifications

FEATURES

-  Balanced flue gas fire
-  Wood logs fuel bed
-  Corner left
-  Ecomax remote control
-  Corner right
-  Antracite steel panel interior
-  Panoramic model
-  Lamelas interior
-  Double burner

OPTIONALS

-  Pebbles fuel bed
-  Wall bracket remote control
-  Carrara fuel bed
-  Domotica smart connection
-  Basalt fuel bed
-  Wall switch
-  Black glass interior
-  Set for app control
-  Anti reflective glass
-  Puck control
-  Mains adapter GV60

If you're looking for a gas fireplace that will draw attention and occupy a prominent spot in your space, the Trimline 140 Corner/Panoramic will mark the end of your search! With this extra wide fireplace, relaxing is taken to a whole other level. A true upgrade for your room.

The standard version of the Trimline 140 Corner/Panoramic has a burner bed made of wooden logs and has a lamelas interior. On top of that, it comes with the Ecomax remote control and you have the options of adding Wi-Fi-control with our Trimline Fires app.



Styling & Optionals

Ecomax remote control

For absolute ease of use all appliances are supplied with an Ecomax remote system that controls the fire at the touch of a button.



Options interior finish materials and Trimline Wi-Fi control

For that extra WOW factor, there is also an option to upgrade to a black glass lining within the combustion chamber which offers a remarkable effect of added depth and detail. Other available upgrades also include Wi-Fi and pebbles, carrara or basalt burner bed.



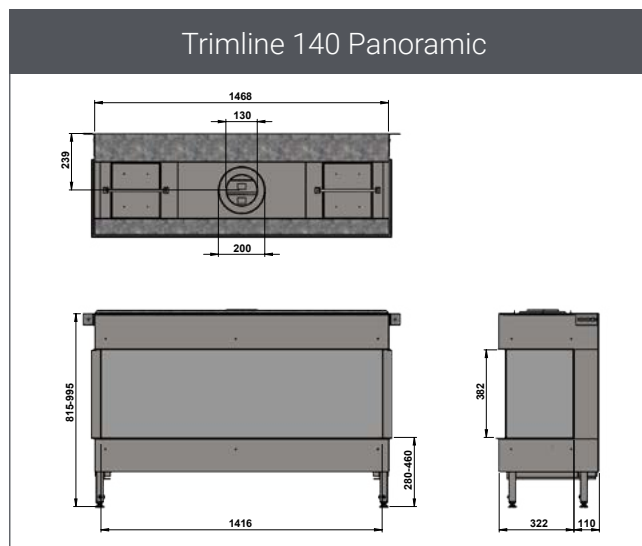
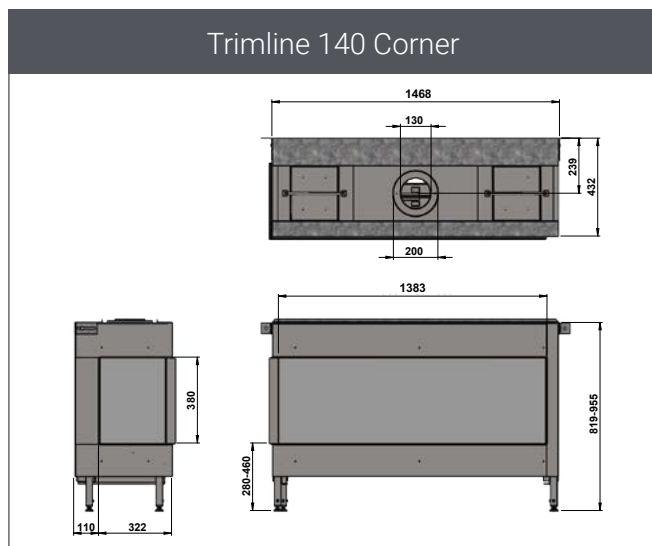

Appliance name	Trimline 140 Corner/Panoramic			
Appliance type	Balanced flue built-in gas fires (C11, C31, C91)			
Purpose	Ambient heating, real flames			
Engine identification	1140 (P), 1141 (CL), 1142 (CR)			
Gas type-pressure	Natural gas G25.3 – 25 mbar	Natural gas G20 – 20 mbar	Natural gas G25 – 20 mbar	LPG G30/31 – 28-50 mbar
Heat input (kW)	13.7	14.5	12.0	12.4
Heat output max (kW)	11.5	12.0	9.8	10.6
Heat output min (kW)	4.3	3.0	3.5	3.0
Consumption (m ³ /h and kg/h LPG)	1.6	1.5	1.5	0.7
Efficiency (%)	84	83	82	86
Energy label highest efficiency	B	B	B	B
Flue lay out wall termination	Indirect 1m vertical and max 5,5m horizontal			
Weight (kg)	180			
Efficiency class EN613	1			
NOx Class	5			
PIN ID CE	0461CQ1040			
Gas connection	3/8" outside connection			
Electrical connection	6 VDC battery powered			
Gas control system	Mertik Maxitrol SYMAX B6R radio controlled 866 mHz			
Safety	Thermocouple flame supervision and pressure hatches			
Heat distribution	Internal convection system			
Connectivity	Optional App control (Android and IOS), wall switch and domotica connection			
Flue type and diameter	Holetherm-CC concentric flue 130-200mm			
Standard supplied	Adjustable legs – Convection chamber and grills – Wall brackets – Log set			
Optional	Support iron for brickwork chimney breast			
Remarks	Always use non-combustible construction materials such as metal stud framing and fireboard cladding			

Installation details

Concentric flue system

Using the THC-CC double wall chimney system the flue gases are safely transported to the outside and fresh combustion-air is pulled inside the appliance. Balanced flue appliances can be installed using a wall terminal so no traditional chimney is needed. THC-CC is made of high quality stainless steel and approved according CE standards in combination with the Trimline appliances.



Balanced flue gas fire

One of the most innovative aspects of the Trimline 140 Corner/Panoramic is that there is no need for an existing chimney to be present. This is all down to the clever features of our balanced flue gas fire, that is fully room sealed. Not only does this make for a highly efficient and safe appliance, but when combined with our concentric flue system, our fires can be positioned in virtually any part of your home with a relatively simple 'chimney breast' built around it. A direct wall outlet from the back of the fire makes the installation even easier.